

TOP 5 Brewery Applications

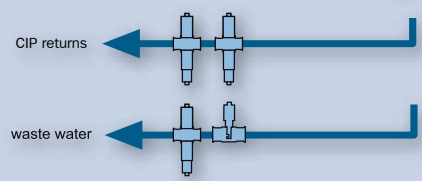

english
deutsch
español
português
русский язык
中文
日本語
français
italiano

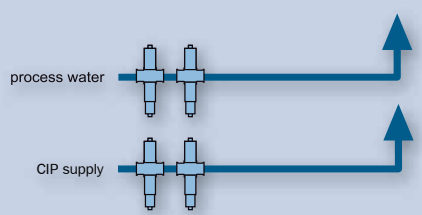

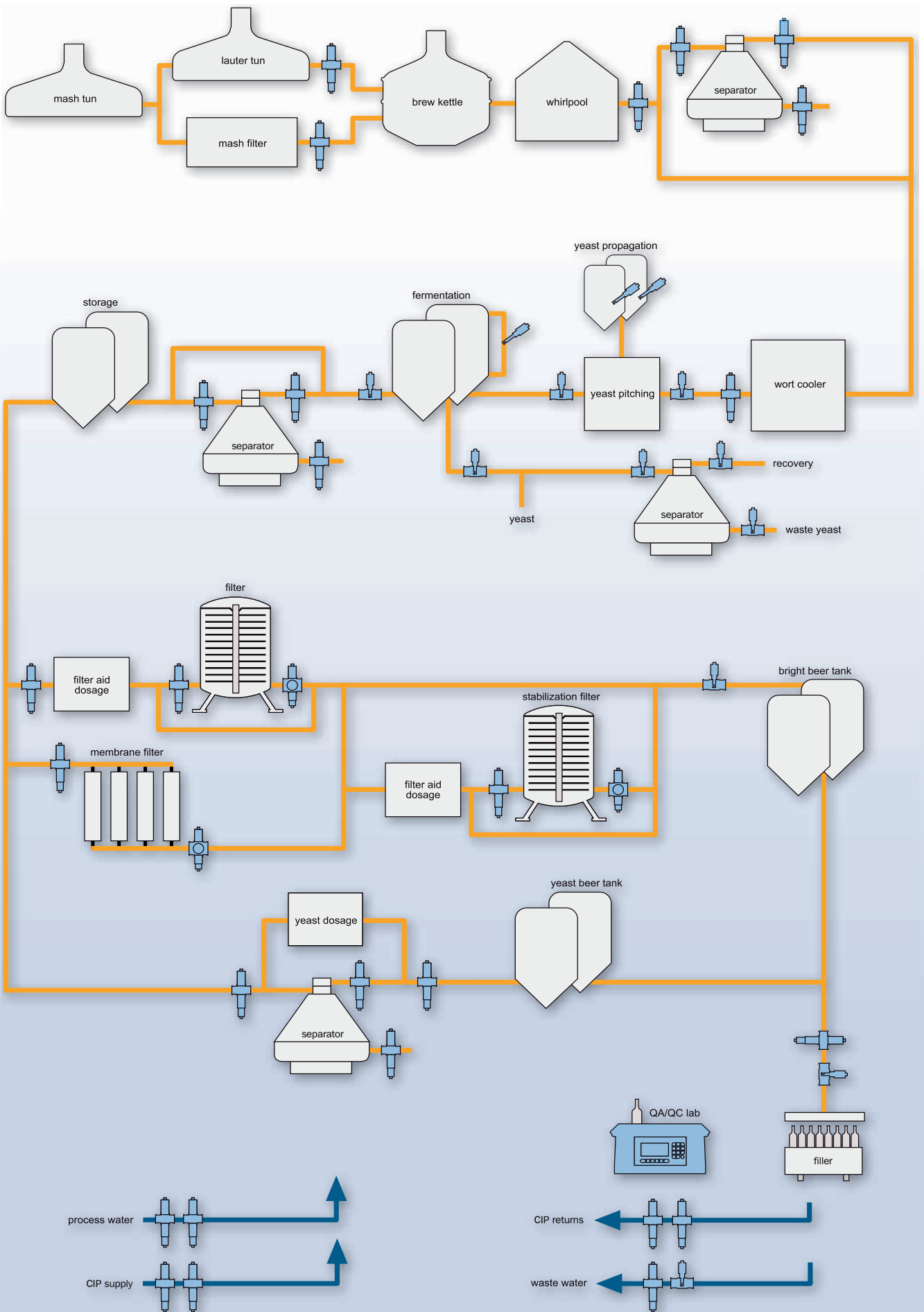

For over 30 years, optek has focused on measuring process liquids through their interaction with light in facilities all over the world. Although global, optek remains a family owned company with a team of more than 100 qualified, customer-driven professionals.

Our confidence is born from experience. With the expertise of more than 30,000 installations worldwide, our value to the customer resides in providing a superior product that pays back. High quality materials withstand the toughest process conditions including aggressive media, high temperature, and

high pressure applications. Cleanability is ensured using high quality wetted materials, superior design, as well as sapphire optical windows.

As a global partner to various industries, optek offers the most advanced technologies including superior signal amplification, inline calibration support, PROFIBUS® PA, FOUNDATION™ Fieldbus and multilingual user interfaces for easy onsite operations.

Our support ensures long term satisfaction with programs such as “Speed-Parts” and “SwapRepair” to provide our

customers sustainable operations and minimized downtime at the lowest cost of ownership.

Conformity to international (ISO 9001), industry-specific (FM/ATEX approval) or company standards is easily achieved with optek. Wherever process composition is controlled, the name optek has become synonymous with world-class products and support.

Optimize your process with optek inline control.



Content

TOP 5 Brewery Applications

Beer Filtration Control 11° / 90°	04
TOP 1 Brewing Filter Control - From Line to Lab	08
TOP 2 Brewing Separator Control	09
TOP 3 Brewing Yeast Management	10
TOP 4 Brewhouse Turbidity	12
TOP 5 ASBC / EBC Beer Color Measurements	13

Optical Sensors- Principles	14
-----------------------------	----

Contact	16
---------	----

04 | Beer Filtration Control 11° / 90°

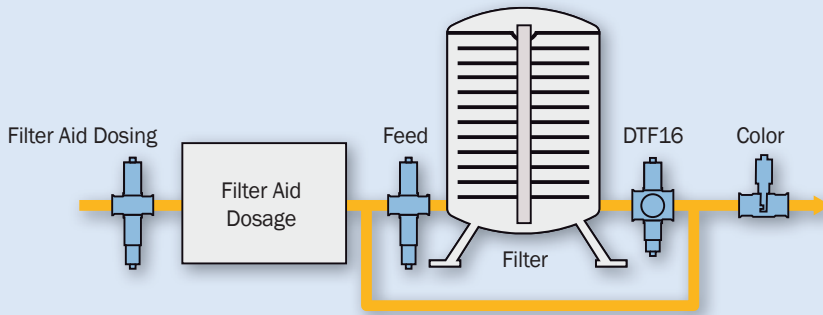

Beer Filtering Control 11° / 90°

The optek Haze Control / DTF16 relies on a dual angle, scattered-light measurement for precise quality control during final beer filtration independent of color and color changes. Using this sensor downstream of the filter monitors filter performance, preventing “out of spec” product while ensuring beer quality and clarity at each filtration step. The 11° channel is sensitive to particle size change and immediately detects break through and other non-normal turbidity events, while the 90° channel quantifies the visual clarity for quality assurance.

Filter Feed Line Monitoring

Using an optek AS16-N or AF16-N, the turbidity in the feed line can be monitored, allowing precise feed control while preventing filter clogging or blinding. Optimized body feed rates has tremendous

impact on filter throughput capacity. This additional sensor can be connected to your Haze Control / DTF16 system without the need for an additional converter.

Filter Backwash Optimization

The optek AS16-N or AF16-N used for feed monitoring can also be used to optimize your filter backwash process by measuring the turbidity in the water, saving time, energy and conserving water usage.

Filter Aid Dosage

Dosage of filter aids like Kieselguhr or PVPP can be controlled with optek absorption or turbidity sensors. Optimizing filter aid usage can dramatically increase throughput capacity and recovered product, and reduce down cycles and costs, all while ensuring consistent product quality.

Beer Interface Detection

The Haze Control / DTF16 system may also be paired with an AS16-F or AF16-F to measure the color of your beer. This measurement controls the phase separation between beer and water ensuring faster product changeovers while maintaining product quality and minimizing product losses.

Filter Setup Monitor

Using the 0° absorption channel of the sensor DTF16, turbidity up to 500 EBC can be measured, allowing you to monitor and control the filter pre-coat cycle. This provides an additional opportunity for filter optimization.



optek Haze Control DTF16 System



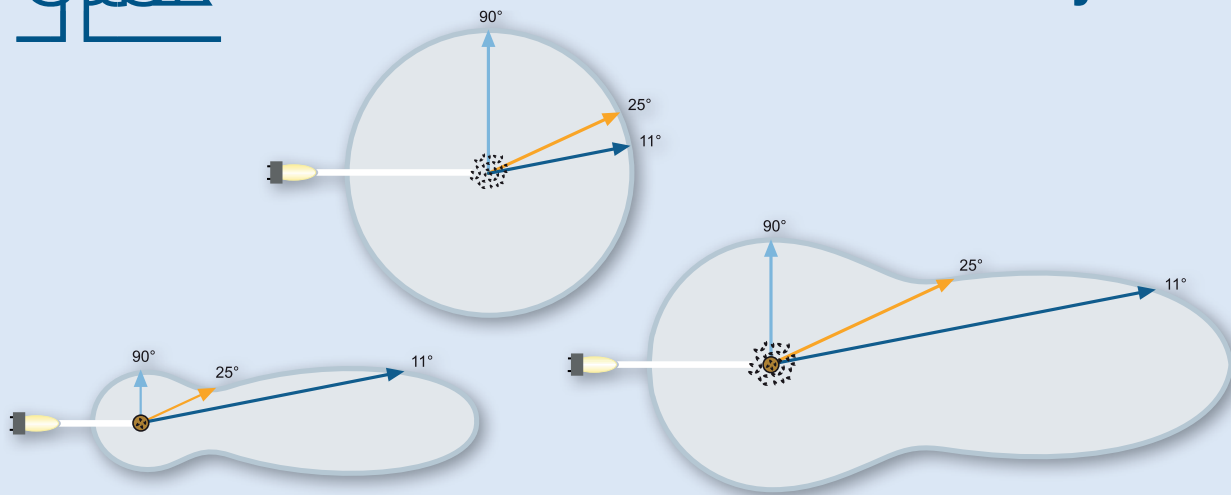

Why use an 11° measurement?

Forward scattered light is particle size sensitive and its strength is in detecting particles such as yeast, trub and Kieselguhr, efficiently detecting filter breaks and filtrate turbidity caused by particles, even at extremely low concentrations. 11° measurements are very sensitive in this regard and correlate well to actual non-dissolved solids content, essential for proper filtration control and optimization.

Why is 11° better than 25° measurement?

Scattered light at 11° is more discrete due to higher signal levels and will detect abnormal particulate faster with less influence from colloidal material common at 25°. This is essential for prompt troubleshooting of non-normal turbidity issues.

Why use a 90° measurement?

Turbidity measurements at an angle of 90° are highly sensitive to colloids and are used as a quality check for the clarity of the beer, based on formazin reference standards. Mistakenly, 90° techniques have been used for process evaluations but do not correlate to actual non-dissolved

solids content. Modern breweries can now measure this parameter inline and as a result provide the ability to release beer automatically.

Why use a 0° absorption measurement?

Using the 0° absorption channel allows measurements at higher turbidity levels, well beyond the range of the 11° or 90° results, allowing to monitor and control the filter pre-coat cycle as well. This provides an additional opportunity for filter optimization.

Why is the reading of lab and process sometimes different?

The beer in the pipe is homogeneous, under pressure, and at a constant temperature. In the lab, the samples have time to change, solids may precipitate and temperature changes will affect the solubility of colloids and with that, the measurement. In addition, differences in the optical configurations of the instruments themselves, along with the calibration methods used, have an influence on comparative results.

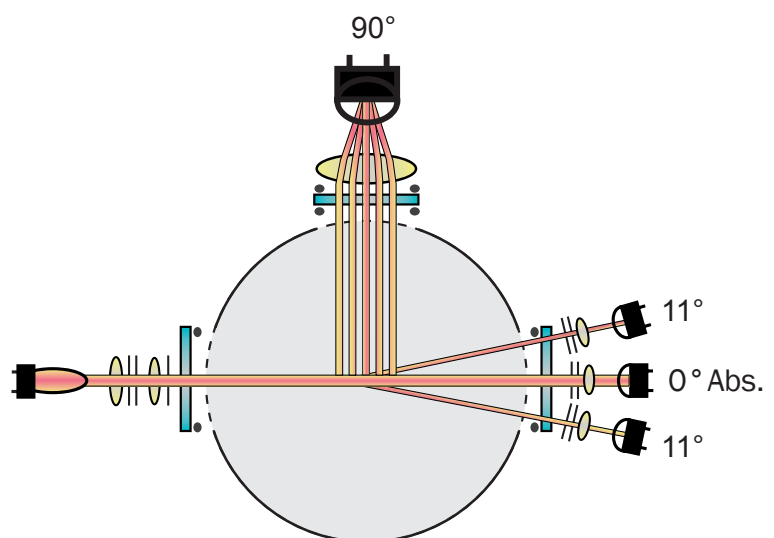

06 | Haze Control – Technology

Filtration Control is Power.

Filtration is one of the most important steps in the brewing process. The optek Haze Control DTF16 allows you to measure and control this crucial process and provides real-time quality assessment. In addition to releasing beer by instrument, there are tremendous opportunities to reduce beer loss, media usage and production costs while increasing filtration capacity and ensuring consistent product quality.

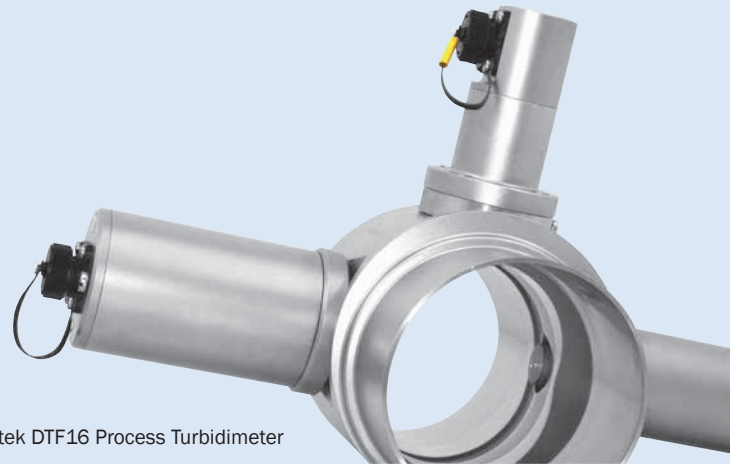

optek DTF16 Process Turbidimeter

Factory Zero Point

The power behind the optek Haze Control DTF16 is the factory zero point. No longer is a questionable zero media (process water) or offline zero procedure required. Using known technical reference solutions and purest zero media, optek developed a factory calibration and a precise zero point. This drift-free factory zero point eliminates the need for regular zeroing of the instrument saving you time and money and does not depend on the operator. It also ensures that every instrument is base lined identically and precisely. This is invaluable when relying on multiple instrument locations.

Factory Calibration

Each and every optek Haze Control DTF16 is factory calibrated to EBC standards which correlate to all other standards currently in use in process plants today. This calibration is stable for the life of the instrument and does not need recalibration, providing a low cost of ownership.

This ensures precise, repeatable and reliable measurements across multiple instruments and locations. User selectable units of measure and built in correlation tables provide unrivalled flexibility to the brewery.

Drift-free by Design

Baseline drift of scattered-light sensors has long been a problematic issue. This is usually caused by unwanted scattered-light, stray light from reflections in the sensor assembly, from the light source itself, worn artificial coatings or external light (i.e. sight glasses). This stray light influences the measurement in an unpredictable fashion.

The optek DTF16 incorporates advanced geometry to eliminate this problem by re-directing the stray light away from the detectors. This design does not rely on any coatings and

maintains a cleanable, sanitary design. Combine this ingenious design with the legendary optek signal amplification stability, dual beam ratio detectors and advanced Haze Control firmware and you get a drift and calibration-free process turbidity analyzer with exceptional long-life performance.

Information on Demand

Designed for ease of use, the Haze Control software has seven languages to choose from. In addition to the four transmitted results, the Haze Control has a built in data logger providing you with continuous trending. This data can be displayed locally and downloaded to a computer allowing production personnel to review process consistencies or track down any historical anomalies or process issues.

Communication

The Haze Control offers multiple communication options. Up to four mA-outputs can be used simultaneously to transmit data or completely control the converter remotely using a standard I/O interface. Also the bus communication PROFIBUS® PA or FOUNDATION™ Fieldbus is available to integrate the system optimally in your (future) bus system.

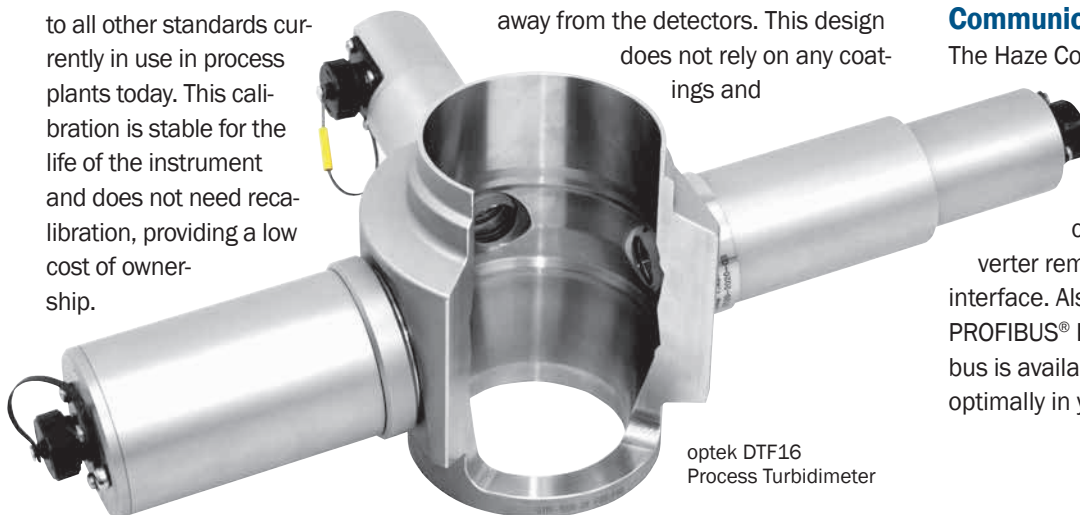

optek DTF16 Process Turbidimeter

Haze Control Units and Measuring Ranges Haze Control DTF16				
Unit	EBC Correlation	90° Side Scatter	11° Forward Scatter	0° Absorption
EBC	1	0 - 25	0 - 25	0 - 500
FTU	4 = 1 EBC	0 - 100	0 - 100	0 - 2,000
NTU	4 = 1 EBC	0 - 100	—	—
ASBC-FTU	69 = 1 EBC	0 - 1,725	—	0 - 34,500
Helms	40 = 1 EBC	0 - 1,000	—	—
ppm (DE)	6.4 ≈ 1 EBC*	—	0 - 200	—



* non linear correlation

The instrument may be set by the operator to various lower ranges which can be displayed and transmitted simultaneously.

- EBC** = European Brewery Convention
- FTU** = Formazin Turbidity Units
- NTU** = Nephelometric Turbidity Units
- ASBC** = American Society of Brewing Chemists
- Helms** = Turbidity Unit
- ppm (DE)** = Parts per Million (Diatomaceous Earth)

Dry Air

optek designs utilize self-contained flow cells, so any sensor service can be performed without shutting down the process line. This results in captive air space that is managed by supplying dry instrument air, to prevent any condensation. The use of air, instead of desiccants packs, eliminates periodic maintenance, assuring long term trouble free service.

Haze Control	Sensor			Communication			
	DTF16 11° / 90°	AS16-N NIR Absorption	AS16-F Color	mA-OUT 0/4 - 20 mA incl. Failsafe	Relays 0 - 50 V DC 0 - 75 V DC	mA-IN 0/4 - 20 mA	Remote-IN 18 - 29 V DC
HC4301	✓	—	—	2	3	—	—
HC4402	✓	✓	—	4	3	—	—
	✓	—	✓				
HC4321	✓	—	—	2	3	2	7
HC4422	✓	✓	—	4	3	2	7
	✓	—	✓				
HC4351	✓	—	—	2	3		
HC4452	✓	✓	—	4	3		
	✓	—	✓				
HC4361	✓	—	—	2	3		
HC4462	✓	✓	—	4	3		
	✓	—	✓				

08 | Brewing Filter Control – From Line to Lab

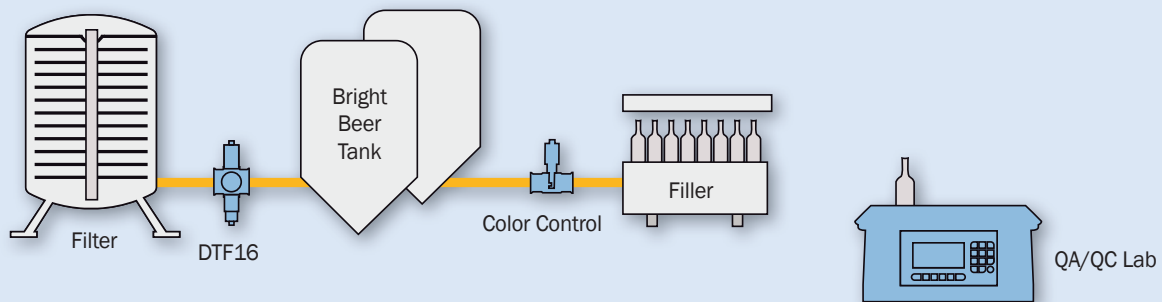

Line and Lab: One optical design

Two optek products are specifically designed for the beverage industry. The optek DT9011 is an “In the Bottle” bench top turbidimeter. The DTF16 is a process scale turbidimeter intended as a true real-time QA/QC turbidity analyzer that can eliminate lab assessments altogether. Both products measure at both a forward scatter angle of 11° as well as the side scatter method of 90°.

Both results are displayed and recorded simultaneously. The measurement results of the DT9011 laboratory system match the DTF16 inline turbidimeters, allowing validation of process readings to the lab. The 90° angle provides the colloidal haze measurement for visual clarity assessment, while the 11° angle provides concise quantification of turbigen content. The 90° results can be read in any preferred haze scale units such as EBC, FTU, Helms, ASBC or NTU. The 11° angle can be read directly in ppm, mg/L, mc/mL, or an appropriate calibration scale, e.g. EBC, FTU. Measuring at both angles provides lab personnel with considerably more data and the ability to discern the nature of any turbidity causing material when analyzing finished beer turbidity.

The 11° forward angle is very sensitive to particle size so it is an indicator of abnormal particulate such as Kieselguhr and yeast. In addition, it correlates very well to actual non-dissolved content allowing us to use ppm (mg/L) as a units scale, while the 90° side-scatter angle provides sensitivity to colloids and haze, providing the visual clarity assessment. Using the 11° forward scatter angle is more specific than 25° and eliminates false high readings due to haze because it is nearly independent of colloidal haze. Any filtration issues, whether recipe, process or equipment related can now be diagnosed much easier by knowing the nature of the turbigens being detected.

Using the optek DT9011 turbidimeter, the sample is placed in a water bath and measured 250 times, at both scatter angles, during one rotation, followed by advanced data analysis. This eliminates the effects of bottle color and shape, as well as scratches, seams and other imperfections in the sample bottle. Our broadband wavelength approach complies with MEBAK, while eliminating under reporting of certain particulate common with monochromatic devices.

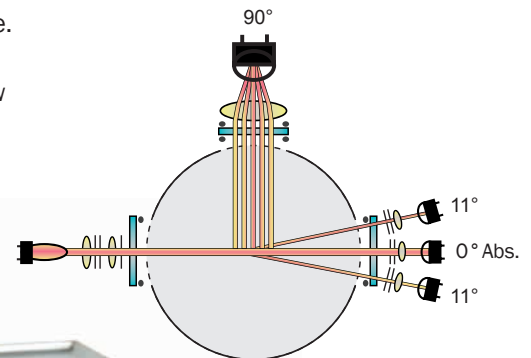

optek HAZE CONTROL DT9011
Laboratory Turbidimeter

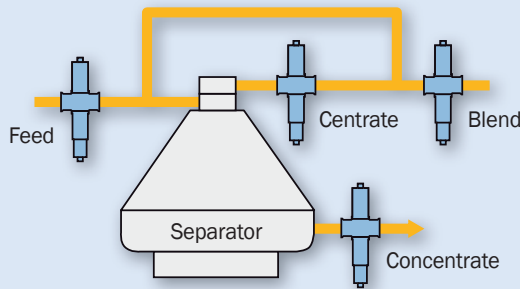

optek C4000 Photometric Converter

Outlet (Centrate) Control

Centrifugal separators / decanters equipped with a NIR absorption based turbidity meter AF16-N or AS16-N on the outlet, can eliminate needless discharges and initiate them only when solids (yeast) carry-over is detected in the centrate stream. Counting the frequency of these discharges is an indicator of incoming solids loads, which can be used to adjust the flow rate to improve separation performance in high load conditions and allows maximum throughput at low load conditions. In some breweries, clarified beer streams are bright enough for release, a TF16-N hybrid scattered-light sensor, with its dual range capability, can be installed instead of a NIR absorption based turbidity meter to precisely monitor very low turbidity bright beers as well as purposely hazy beers.

Feed Control

Adding a second NIR absorption based turbidity meter AF16-N or AS16-N to the feed line, and measuring incoming loads directly, allows immediate response to varying brewing process conditions, allowing flow rate staging as well as diverting high solids slugs to prevent plugging up a separator bowl. One mishap like this costs more than the analyzers used to prevent it. Of course proper beer/yeast interface detection upstream will also prevent unacceptably high solids loads from shutting down a separator. In this case, an AS16-N probe would detect the transition to beer and provide precise yeast cropping control.

Bypass Blend Control

In some cases, a bypass line is used to dose a certain amount of unfiltered beer or yeast back into the clarified beer stream. The addition of a second, matching turbidimeter, downstream of the bypass injection point, can be useful for yeast concentration control using a differential measurement technique. With this instrumentation

constant beer quality can be ensured. Control the turbidity inline, in real-time, without the need for sample taking or manual dosing, saving time and money.

Concentrate Control

The concentrate stream of a separator can be equipped with a NIR absorption based photometer AS16-N or AF16-N using a very short optical path length to accurately correlate absorption measurements directly to weight / percent. This enables yield measurement and control of sales yeast quality.



optek AF16-N
Single Channel Absorption Sensor

10 | Brewing Yeast Management

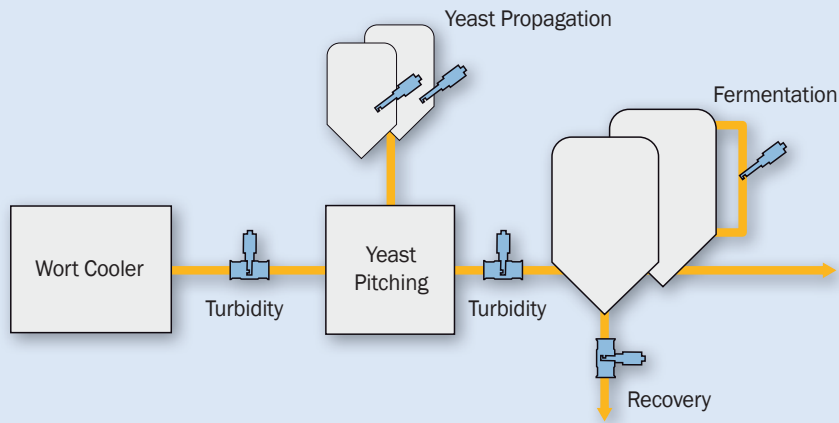

Pitching Yeast

Yeast dosing can be done precisely and inexpensively using a technique called differential NIR absorption. This method uses two sensors. The first or upstream sensor is a single channel, NIR absorption based AS16-N photometer used to “baseline” the wort turbidity.

This sensor often can double as a whirlpool outlet monitor, or a cold break monitor, depending on its location in the brewhouse. The downstream AS16-N sensor would be located after the yeast injection point, prior to any air injection. This sensor measures the combined yeast and wort stream. Simply subtract the baseline result from the combined stream result to get pure injected yeast content.

With a simple comparison to the yeast lab cell count method, the correlation to cell count can be programmed directly in the C4000 converter and displayed simultaneously. Multiple strains with different absorption / cell count ratios can also be accommodated by using additional product configurations. There are a total of eight product definition set-ups available.

Correlation of Absorption to Million Cells / mL

NIR absorbance is directly proportional to the concentration based on Lambert-Beer’s Law. Correlations to cell count are easily done with any repeatable laboratory method. Multiple product functions in the C4000 allows multiple correlations for different yeast strains if required.



optek AS16-VB-N
Single Channel Absorption Probe
with Calibration Adapter



optek C4000 Photometric Converter

Yeast Fermentation

In yeast fermentations, AS16-N probes have the unique ability of mounting directly in the fermentation vessel or directly in a bypass line via different adaptors. Properly located, the entire fermentation cycle can be monitored in real-time, allowing optimization of the process. Tanks can be released automatically rather than waiting hours for lab samples to indicate proper yeast flocculation. Feedback on any recipe influences of yeast cell growth can also be seen. In larger cellars, saving 6-10 hours per fermentation cycle can add up quickly, adding valuable fermentation capacity, without adding a single fermenter.

Beer / Yeast Interface, Harvesting Yeast

Many breweries are using large vertical fermenters or multi-purpose tanks. One of the main advantages of these tanks is avoiding extra product transfers. However, settled yeast must be

removed. A turbidity sensor is installed in the tank outlet, or in the yeast harvest line. When the yeast is removed from the beer the turbidity meter will determine the interface between the yeast and beer. In the past this was accomplished by time / volume or visual inspection. Since the set points are adjustable the optimal cut-off level can be obtained to provide the most efficient operation. This reduces product loss and provides a more uniform product for separation or filtration.

Beer / yeast interface and yeast harvesting also typically uses the AS16-N inline sensor. However, for basic interface applications, where the interface detection is the only objective, optek offers a lower cost probe style sensor in the AS56-N. Its lower power lamp module also allows up to four AS56-N series probes to be multiplexed in one C4000 based system, thus making the measurement point cost even more attractive.

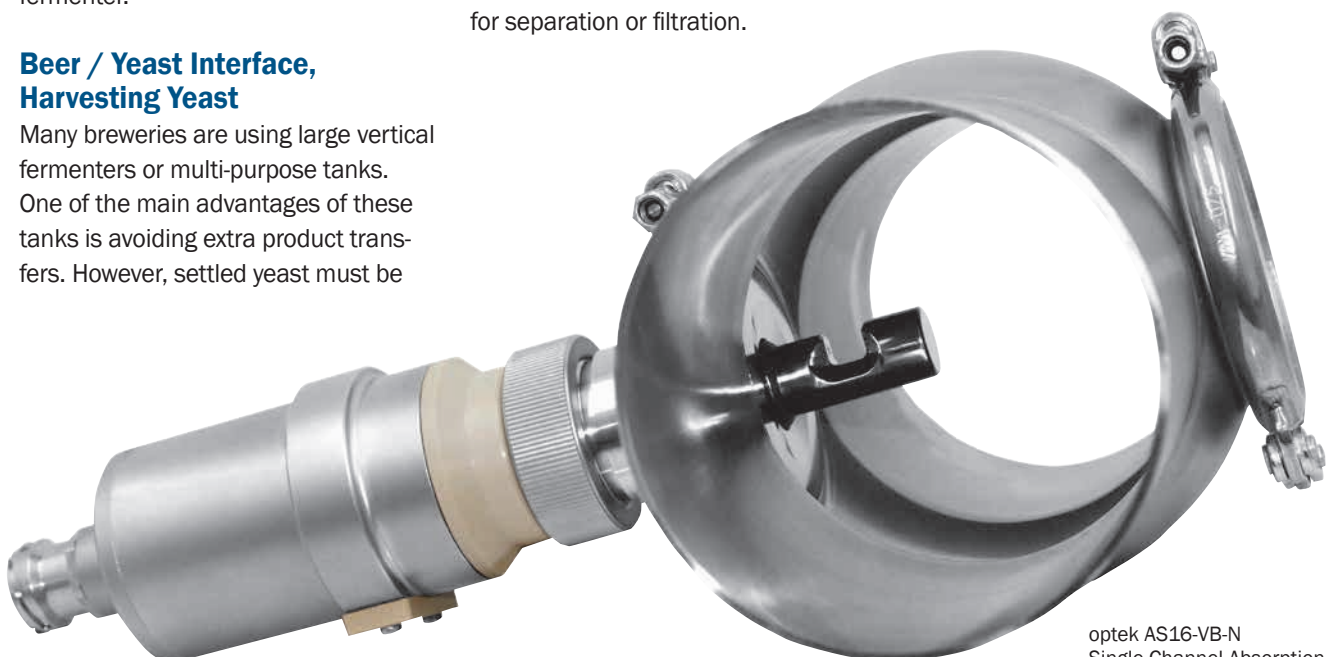

optek AS16-VB-N Single Channel Absorption Probe with Calibration Adapter

12 | Brewhouse Turbidity

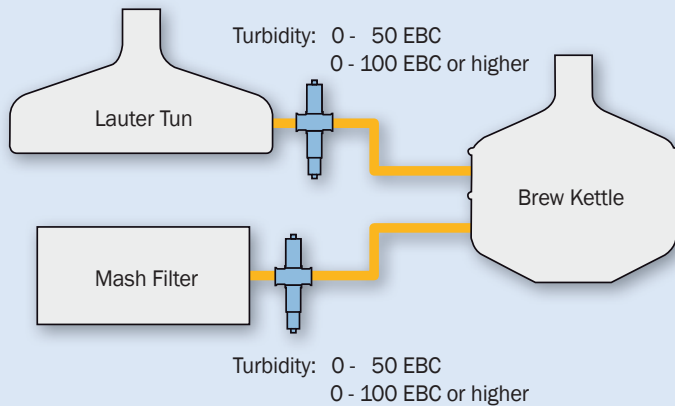

Wort Clarity Monitoring

Lauter tun run-off clarity or Vorlauf, has traditionally been a hands-on monitoring operation performed by brewery personnel; however, this is now commonly done with a TF16-N scattered-light turbidity meter.

The measuring ranges depend on the clarity levels reached and on measurement expectations. This turbidity meter continuously monitors solids concentrations in the extract stream to automatically indicate a switch to flow forward to the brew kettle when the desired clarity level is achieved.

More importantly, it can automatically react to any husk bed upsets or elevated solids concentrations due to bed cuts. While in forward flow mode, this measurement result can be read in ppm (mg/L) or be correlated to % TSS (total suspended solids), which can then be combined with flow data to create a flow weighted average of total solids transferred. Control of the wort production process offers predictable downstream solids content for both operational efficiency and flavor / clarity stability.

Mash Filter Monitoring

Using a mash filter for clarifying the wort makes the turbidity measurement even more important. Achieve better product quality by decreasing product losses and improving filter lifetime. Filter breaks can be immediately detected using a scattered light based TF16-N turbidity meter, to precisely monitor very low particle concentrations as well as a more broad turbidity range using the absorption signal simultaneously. Automated alarms will signal any filter breakthrough, while filter set-up times, throughput capacity and CIP cycle duration can be optimized.

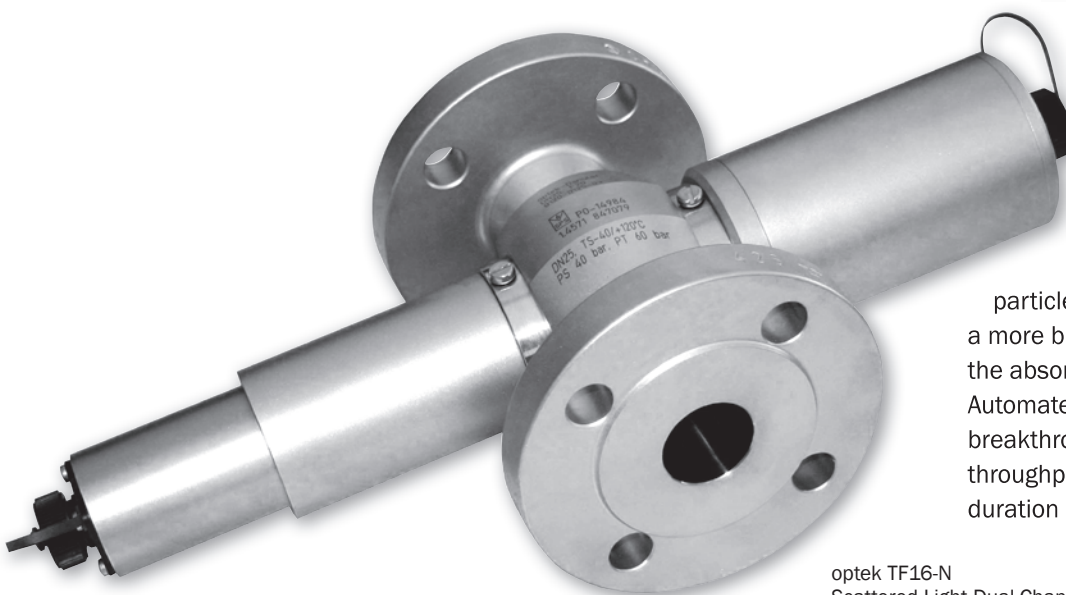

optek TF16-N
Scattered Light Dual Channel Turbidity Sensor

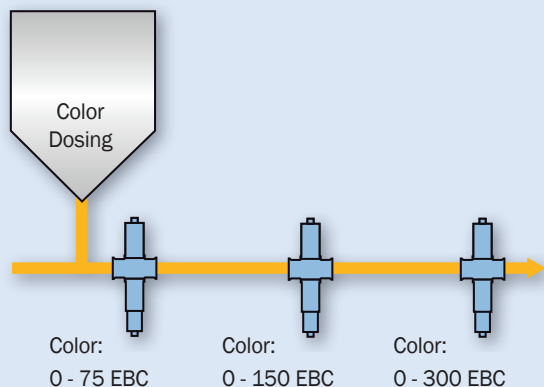

optek AF26-VB-PV
Dual Channel Absorption Sensor
with Calibration Adapter

Beer Color is Important

The use of precision colorimeters before the fillers can provide beer color dosing control and quality control based on specific color aspects of the brands. Single or dual beam colorimeters configured to monitor specific visible wavelengths can offer continuous inline monitoring to minimize sampling and lab analysis. A consistent visual impression for the end customer is as important as the possibility for product identification.

Wort Color

Wort color is also measured using absorption. However, beer color is measured using visible light (VIS) at 430 nm. In the brewhouse this poses a problem as background turbidity (solids) will also absorb light at 430 nm. To compensate for this, optek measures at two wavelengths, one at 430 nm and a second reference wavelength in the near infrared (NIR).

Subtracting the absorbance signal of the reference channel from the primary, visible channel signal gives a pure beer color measurement. This result is then correlated to ASBC or EBC color scales using the software features of the C4000 photometric converter. The optek AF26, dual channel absorption based colorimeter is ideal for this application. Simultaneously, the reference channel can monitor trub and

cold break if the AF26 is strategically located after the wort cooler.

Beer Color Dosing

The color of some beers will be adjusted using malt extract or rye malt beer for example. Dosage can be controlled using an optek colorimeter. The color of the beer is measured and automated signals i.e. relays, 4-20 mA analog signals, or Bus Systems, can be used to trigger pumps or drive control loops to start and control dosing the color into the beer stream. After the dosage, the color can be verified by a secondary colorimeter. Color of dark and bright beers, as well as the color of high gravity beer after blending can all be controlled.

Beer Interface Detection/ Beer Phase Separation

Precise process interface detection with a single channel VIS absorption based colorimeter (insertion probe style) is the easiest and least expensive technique available to brewers today to reduce product losses. The AF26 performs this function as well. In a large brewery, the sheer number of change-over operations per day can cost the brewer thousands of hectolitres of product and by-products each week.

Optical photometers provide an immediate response to beer phase separations (change-overs), saving as much

as seven seconds per transition over other sensor technologies. In some cases, the water pushout sequence can be reduced from flushing the entire pipeline to simply introducing a small amount of water between brand changes or even eliminating the water step entirely by directly sensing the change in brand color.

In today's economy, recovering this product is essential to maintain a profitable business; however, the costs go beyond the product alone. Water as the push-out medium is also a commodity and has an inherent cost to procure and treat. Product and water, along with yeast, going needlessly down the drain are large contributors to brewery waste / plant effluent and the costs to treat it. Local municipalities may also be involved; applying charges to the volume of effluent and even fines if solids load or BOD limits are exceeded. Gaining control of plant interface functions not only makes sense, it's also environmentally friendly. All of these factors contribute to lower costs per barrel and assure consistent product quality.

14 | Optical Sensors- Principles

Probe AS16 / AS56

VIS- and NIR-Absorption,
Single Channel Concentration and
Color Measurement

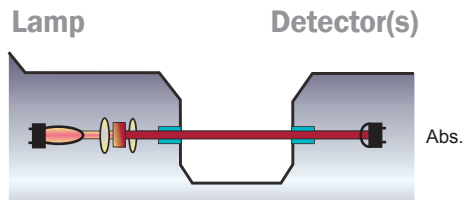

Sensor AF16

VIS- and NIR-Absorption,
Single Channel Concentration and
Color Measurement

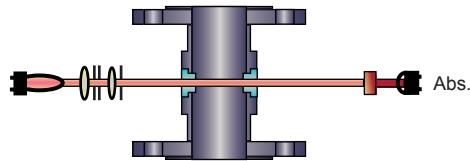

Sensor AF26

VIS-Absorption,
Dual Channel Color Measurement with
Turbidity Compensation

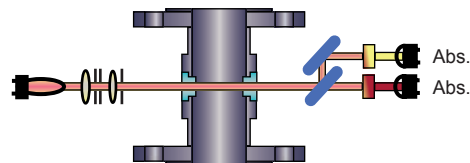

Sensor TF16

11° Scattered Light and NIR-Absorption
Dual Channel Turbidity Measurement

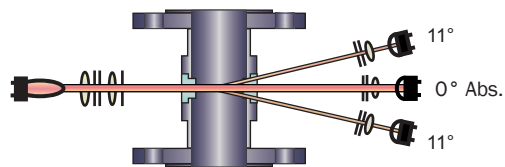

Sensor DTF16

Triple Beam Scattered-light Optical Design
11° / 90° Scattered-light with
Light Compensation Reference Channel and
additional Absorption Measurement for
high concentration

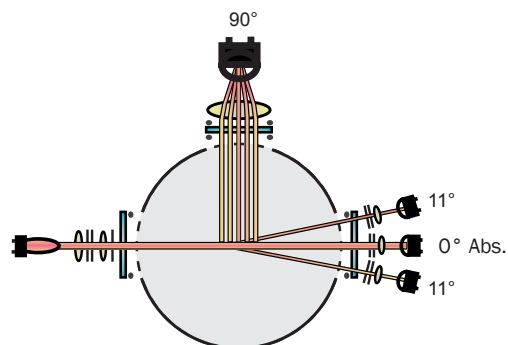



**optek Advantage:
Control is Power**

Today, more than ever, the need for process optimization, product recovery, cost reduction, and reduced waste is the key to a successful business.

Real-time data from reliable process scale analyzers from optek is essential to gain complete process control, realize optimization potential and ensure profitability.

A brewery can't manage what it doesn't measure.



... and above all else:

Thank you for brewing!
Here at optek we are all your customers too!

See our various product and application brochures for further details



Germany

optek-Danulat GmbH
Emscherbruchallee 2
45356 Essen / Germany
Phone: +49 201 63409 0
E-Mail: info@optek.de



USA

optek-Danulat Inc.
N118 W18748 Bunsen Drive
Germantown WI 53022 / USA
Phone: +1 262 437 3600
Toll free call: +1 800 371 4288
Fax: +1 262 437 3699
E-Mail: info@optek.com



Singapore

optek-Danulat Pte. Ltd.
25 Int'l Business Park
#02-09 German Centre
Singapore 609916
Phone: +65 6562 8292
Fax: +65 6562 8293
E-Mail: info@optek.com.sg



China

optek-Danulat Shanghai Co., Ltd.
Room 718 Building 1
No.88 Keyuan Road
Pudong Zhangjiang
Shanghai, China 201203
Phone: +86 21 2898 6326
Fax: +86 21 2898 6325
E-Mail: info@optek-danulat.com.cn

中国

优培德在线测量设备（上海）
有限公司
上海张江科苑路88
号德国中心718
室 邮编:201203
电话:+86-21-28986326
传真:+86-21-28986325
E-Mail: info@optek-danulat.com.cn

Please visit our website for contact details of our local distributors in other countries.
www.optek.com