

mini CORI-FLOW™ M15

Compact Coriolis Mass Flow Meters & Controllers for Liquids and Gases

General

Coriolis mass flow meters are highly appreciated for their accuracy and independence of fluid properties. The direct Coriolis mass flow measuring principle is generally used for higher flow rates. However, Bronkhorst® has succeeded in applying this technique for low to very low flows. Moreover, **mini CORI-FLOW™** instruments have an integrated PID-controller and a batch counter to control the fluid flow.

mini CORI-FLOW™ model M15

In addition to the previously developed **mini CORI-FLOW™** series M12-M14 for ranges from 0,1 g/h up to 30 kg/h, Bronkhorst® developed the new model M15 for mass flow rates between 0,2 and 300 kg/h. Similar to the models for lower flow rates, M15 contains a uniquely shaped, single loop sensor tube, forming part of an oscillating system. When a fluid flows through the tube, Coriolis forces cause a variable phase shift, which is detected by sensors and fed into the integrally mounted pc-board.

The resulting output signal is strictly proportional to the real mass flow rate. All instruments of the **mini CORI-FLOW™** series feature density and temperature of the fluid as secondary outputs. Furthermore the instruments offer "scalable range" functionality: factory calibrated ranges can be rescaled by the user, maintaining the original accuracy specs. As a result of this, customers are able to reduce the variety of instruments and thus reduce the cost of ownership. The instruments are equipped with a robust IP65 weatherproof housing and are available with optional ATEX approval for use in Zone 2 hazardous areas.

Fields of application

mini CORI-FLOW™ instruments can be applied for both gases and liquids in process fluid measurement or control systems in (petro-) chemical and pharmaceutical industries, food & beverage applications and liquid dosing systems in a wide variety of markets.



mini CORI-FLOW™ M15 Mass Flow Meter

Features

- > direct flow measurement, independent of fluid properties
- > integrated PID controller for control valve or pump
- > CORI-FILL™ batch dosing functionality
- > fast response time
- > high accuracy, excellent repeatability
- > additional density and temperature outputs
- > compact design (same footprint as CORI-FLOW™ M50 series)
- > excellent price/performance ratio
- > scalable range: easy on site re-ranging via digital interface (large rangeability)
- > no dead volume (single, uninterrupted tube)
- > insensitive for environment vibrations
- > analog I/O-signals, RS232-connection, optional on-board fieldbus interface
- > IP65 design, optional ATEX approval Cat.3, Zone 2

Technical specifications

Flow ranges

	Unit	M15
Minimum flow	[g/h]	200
Minimum full scale	[kg/h]	5
Nominal flow*	[kg/h]	100
Maximum full scale	[kg/h]	300
Rangeability meter		1:100
Rangeability controller		≥ 1:50

* $\Delta p = 1 \text{ bar}$ for H_2O

Mechanical parts

Material (wetted parts)	Stainless steel AISI 316 or equivalent; Other materials on request
Process connection	Compression type or face seal couplings (welded)
Outer seals	Metal
Weight	Meter: approx. 5 kg; Controller: on request
Ingress protection	IP65 (weatherproof)
Leak integrity	Outboard $< 2 \times 10^{-9}$ mbar l/s He
Pressure rating	100 bar

Dimensions Mass Flow Meter/Controller

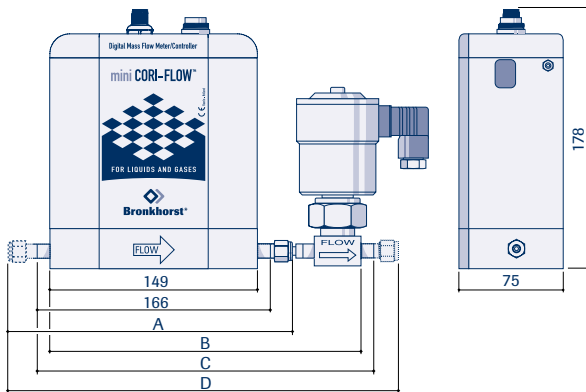

The valve in this drawing is the CSI. Other valves have different shapes.

Model (values in mm)	A	B	C	D
M15 (1/4" OD)	204	-	-	-
M15 (1/4" VCR)	203	-	-	-
M15+C0I (1/4" OD)	204	219	236	274
M15+C0I (1/4" VCR)	203	219	236	271
M15+C2I (1/4" OD)	204	219	236	274
M15+C2I (1/4" VCR)	203	219	236	271
M15+C5I (1/4" OD)	204	219	236	274
M15+C5I (1/4" VCR)	203	219	236	271
M15+F033CI (1/4" OD)	204	283	n/a	338
M15+F004AI (1/4" OD)	204	270	n/a	326
M15+F004AI (1/4" VCR)	203	270	n/a	319

For other models contact factory.

Electrical properties

Power supply	+15...24 Vdc $\pm 10\%$ Max. ripple recommended: 50 mV tt
Power consumption	Meter: 3 W; Controller: max. 7 W
Analog output / command	0...5 (10) Vdc or 0 (4)...20 mA (sourcing output)
Digital communication	Standard: RS232 Options: PROFIBUS DP, DeviceNet™, Modbus-RTU, FLOW-BUS
Electrical connection	
Analog/RS232	8-pin DIN male;
PROFIBUS DP	bus: 5-pin M12 female; power: 8-pin DIN male;
DeviceNet™/Modbus-RTU/ FLOW-BUS	5-pin M12 male

Performance

Mass flow accuracy liquids	$\pm 0,2\%$ of rate
Mass flow accuracy gases	$\pm 0,5\%$ of rate
Repeatability	$\pm 0,05\%$ of rate + $\frac{1}{2}[ZS \times 100/\text{flow}]\%$
(based on digital output)	(ZS = Zero Stability)

Note: optimal accuracy will be reached after approx. 30 minutes after instrument power-up.

The indicated accuracies are based on mass flow (e.g. g/h, kg/h, etc.). If the instrument will be used on volume flow (e.g. l/h, ml/min, etc) this will introduce an extra inaccuracy, based on the density (measurement).

	Unit	M15
Zero stability (ZS)*	[g/h]	$< \pm 50$
Density accuracy	[kg/m ³]	$< \pm 5$
Temperature accuracy	[°C]	$\pm 0,5$
Initial heating at zero flow	[°C]	$\leq 10^{**}$

* The zero stability is guaranteed at constant temperature and for unchanging process and environment conditions.

** Total heating up of instrument depends on flow rate, heat capacity fluid, T amb., T fluid and cooling capacity.

Mounting	In any position (attitude sensitivity negligible)***
Device temperature	0...70°C; for ATEX Cat.3, Zone 2 max. 50°C
Typical meter response time ($\tau_{98\%}$)	0,2 s
Typical settling time controller (<2% of setpoint)	1 s

*** External shocks or vibrations should be avoided.

Note: Technical specifications in this brochure subject to change without notice.

Mass Flow Meter

Capacities

Model	smallest range	nominal range	highest range*
M15	0,2...5 kg/h	1...100 kg/h	3...300 kg/h

*Maximum capacities depend on the available pressure difference across the mass flow meter, especially when used on gases.

Application on gases

In comparison with thermal mass flow devices, the Coriolis measuring principle offers the following advantages:

- no conversion factors (if scaled in units of weight)
- possibility to measure unknown fluids or variable mixtures
- can measure (super-) critical gases
- superior accuracy and response time

For gas flow applications, the mass flow accuracy is better than $\pm 0,5\%$ Rd. The trumpet graph below illustrates the total mass flow accuracy of an M15 Mass Flow Meter used on gas.

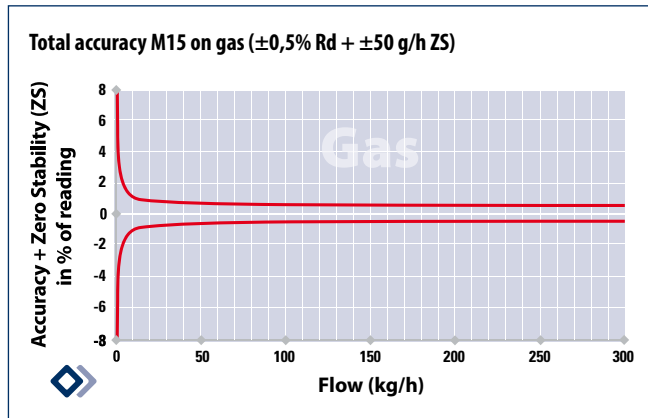

When engineering your process system for gases consideration must be given to the pressure drop across the flow meter and its associated piping.

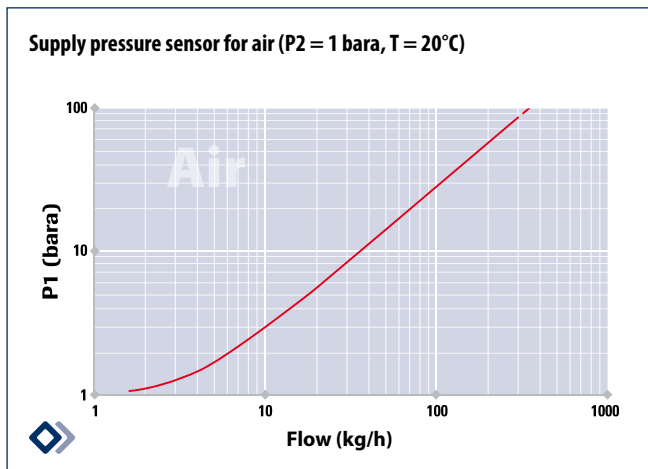

Application on liquids

mini CORI-FLOW™ can be applied for most liquid types. The mass flow meters are fully metal sealed, controllers have a high performance elastomeric valve seat, made of Kalrez.

High accuracy

Coriolis flow meters are unmatched in accuracy. When applied for liquids, the mass flow accuracy is better than $\pm 0,2\%$ Rd.

The trumpet graph below illustrates the total mass flow accuracy of an M15 Mass Flow Meter used on liquid.

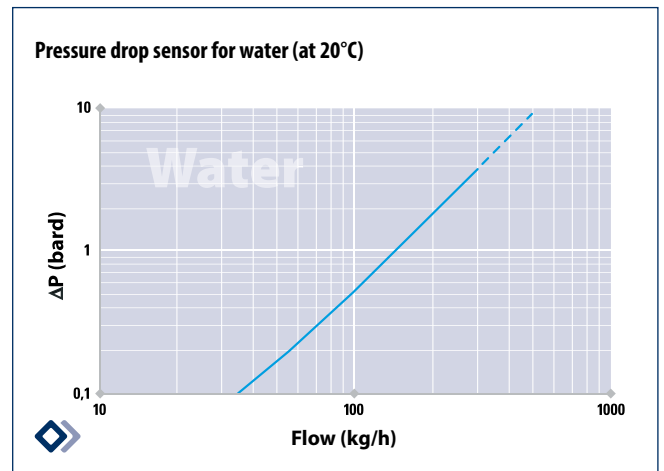
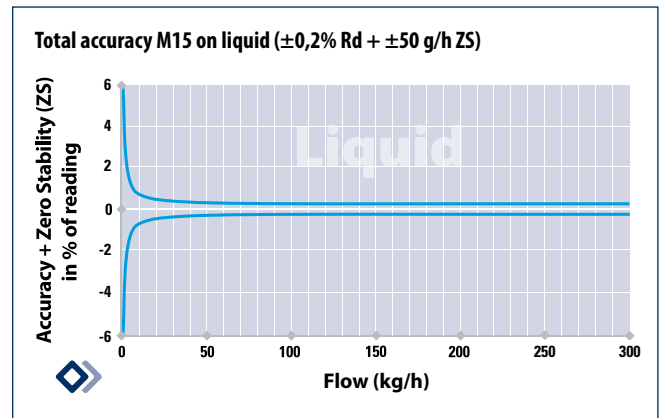

Calibration

References

Verified by NKO, the Dutch calibration organisation, and VSL traceable to Dutch and international standards

Calibration fluid

Multi-range calibration on H₂O

Specifications are based on reference conditions of 20°C. Technical specifications subject to change without notice

Mass Flow Controller

Close-coupled control valves

For control applications M15 **mini CORI-FLOW™** meters offer integrated, adaptable PID control for fast and smooth control of close-coupled control valves. This could be a standard direct acting, electro magnetic control valve or, for instance, a pilot operated valve for applications with high differential pressure.

Close-coupled control valve options:

M15+C01: Gas flow control valve (nc), $K_v\text{-max}=6,6 \times 10^{-2}$
M15+C21: Liquid flow control valve (nc), $K_v\text{-max}=2,3 \times 10^{-3}$
M15+C51: Gas/Liquid flow control valve (nc), $K_v\text{-max}=6,6 \times 10^{-2}$
M15+F-004A1: Gas/Liquid flow control (nc), $K_v\text{-max}=3,0 \times 10^{-1}$
M15+F-004B1: Gas/Liquid flow control (nc), $K_v\text{-max}=1,0$

Bronkhorst® can also offer a mass flow meter in combination with pressure actuated control valves, supplied by a third party. Please contact factory for a customised advice.

Mass flow control with pumps

In some applications it is not possible or not recommended to use a control valve, for instance when a vessel with liquid cannot be pressurised. As an alternative, Bronkhorst® can offer virtually pulse-free pumps, close-coupled to the Coriolis flow meter.

Unique option

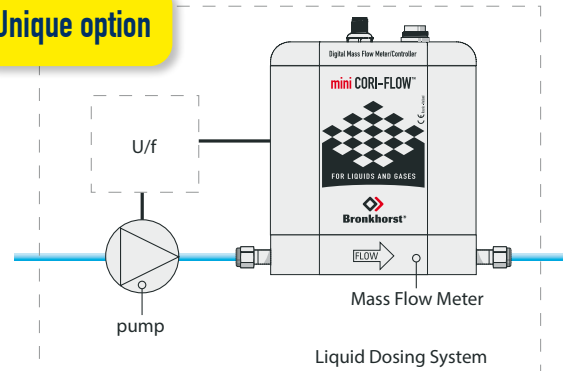

mini CORI-FLOW™ incorporates PID control as standard

Control performance

mini CORI-FLOW™ Mass Flow Controllers feature a highly stable control output and fast response; see depicted response curve with some typical setpoint changes.

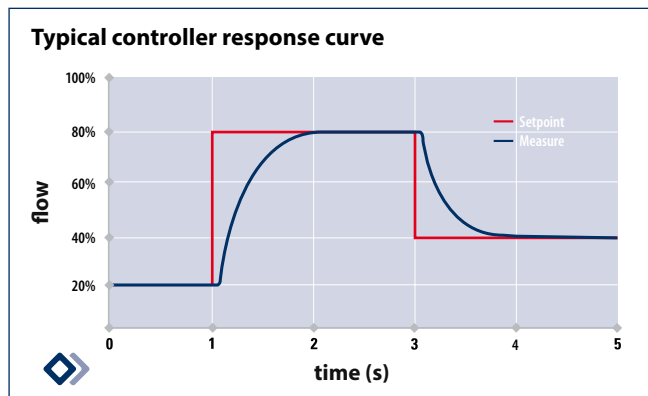

Thanks to the extremely fast sensor (50...200 msec) it is possible to achieve very fast control e.g. for dosing applications. Contact your local distributor for more information.

Pressure drop Mass Flow Controllers

As a rule of thumb the pressure difference (ΔP) across the control valve should be at least 50% of the total ΔP across the system for liquid applications, for gases preferably even higher (approx 75%).

Batch dosing with proportional valves and pumps

mini CORI-FLOW™ instruments are capable of operating with proportional valves or (gear) pumps using the integrated PID-controller. Thanks to **CORI-FILL™** technology, all batch counters now have an extra P-controller to make the valve close or make the pump stop smoothly as soon as the batch total is reached.

When using shut-off valves **CORI-FILL™** technology includes an automatic overrun correction on batch dosing. After just a few doses the accuracy will be optimized. Physical delays and pressure disturbances which might cause under- or over-runs will be automatically compensated.

Features

- > "First time right" batch (no overrun correction needed when using a PID controller i.c.w. proportional valves or pumps)
- > Fast dosing < 0,5 seconds (using shut-off valves)
- > Filling accuracy for batchdosing:
 - For liquids: < 0,5%
 - For gases: < 1%

Shut-off valves

mini CORI-FLOW™ instruments are capable of operating with both +24Vdc electric shut-off valves and pneumatic valves. Electric valves can be operated within a special power saving mode to reduce energy consumption and minimize temperature increase thereby reducing the risk of fluid evaporation.

