**User's
Manual**

FX1000™

**Model FX1002/FX1004/
FX1006/FX1008/FX1010/FX1012
FX1000 Paperless Recorder**

Introduction

Thank you for purchasing the FX1002, FX1004, FX1006, FX1008, FX1010, or FX1012 Paperless Recorder (hereafter referred to as “FX” or “FX1000”).

This User’s Manual explains how to use the FX. To ensure correct use, please read this manual thoroughly before operation.

The following manuals are provided for the FX:

- **Paper Manual**

Manual Title	Manual No.	Description
Model FX1002/FX1004/FX1006/FX1008/ FX1010/FX1012 FX1000 Paperless Recorder Safety Precautions and Installation Guide Installing the FXA120 DAQSTANDARD FX1000 Mode Transition Diagram Setting Mode / Basic Setting Mode Maps	IM 04L21B01-03EN	This guide is printed on A3-size paper and explains the followings: <ul style="list-style-type: none">• Safety precautions• Installation Guide• How to install the FXA120 DAQSTANDARD• FX1000 Mode Transition Diagram, Setting Mode / Basic Setting Mode Maps

- **Electronic Manuals**

Manual Title	Manual No.	Description
Model FX1002/FX1004/FX1006/FX1008/ FX1010/FX1012 FX1000 Paperless Recorder User’s Manual	IM 04L21B01-01EN	This manual. Describes how to use the FX. The communication and network functions, custom display functions, and some of the options are excluded.
Model FX1002/FX1004/FX1006/FX1008/ FX1010/FX1012 FX1000 Paperless Recorder First Step Guide	IM 04L21B01-02EN	Explains the basic operations of the FX.
Model FX1002/FX1004/FX1006/FX1008/ FX1010/FX1012 FX1000 Paperless Recorder Safety Precautions and Installation Guide Installing the FXA120 DAQSTANDARD FX1000 Mode Transition Diagram Setting Mode / Basic Setting Mode Maps	IM 04L21B01-03EN	This is the same as the printed copy.
Model FX1002/FX1004/FX1006/FX1008/ FX1010/FX1012 FX1000 Paperless Recorder Communication Interface (/C2, /C3, and /C7)	IM 04L21B01-17EN	Describes how to use communication functions through an Ethernet or serial interface.
FXA120 DAQSTANDARD for FX1000 Data Viewer	IM 04L21B01-63EN	Describes how to use the DAQSTANDARD viewer.
FXA120 DAQSTANDARD for FX1000 Hardware Configurator	IM 04L21B01-64EN	Describes how to use the DAQSTANDARD hardware configurator.
Model FX1002/FX1004/FX1006/FX1008/ FX1010/FX1012 FX1000 Paperless Recorder Usage Precautions	IM 04L21B01-91EN	Usage Precautions

Notes

- The contents of this manual are subject to change without prior notice as a result of continuing improvements to the instrument’s performance and functions.
- Every effort has been made in the preparation of this manual to ensure the accuracy of its contents. However, should you have any questions or find any errors, please contact your nearest YOKOGAWA dealer.
- Copying or reproducing all or any part of the contents of this manual without YOKOGAWA’s permission is strictly prohibited.
- The TCP/IP software of this product and the document concerning the TCP/IP software have been developed/created by YOKOGAWA based on the BSD Networking Software, Release 1 that has been licensed from the Regents of the University of California.

QR Code

The product has a QR Code pasted for efficient plant maintenance work and asset information management.

It enables confirming the specifications of purchased products and user's manuals. For more details, please refer to the following URL.

<https://www.yokogawa.com/qr-code>

QR Code is a registered trademark of DENSO WAVE INCORPORATED.

Trademarks

- Microsoft and Windows are registered trademarks or trademarks of Microsoft Corporation in the United States and/or other countries.
- Adobe and Acrobat are registered trademarks or trademarks of Adobe Systems Incorporated.
- Company and product names that appear in this manual are registered trademarks or trademarks of their respective holders.
- The company and product names used in this manual are not accompanied by the registered trademark or trademark symbols (® and ™).

Revision History

1st Edition: November, 2011

2nd Edition: September, 2012

3rd Edition: January, 2013

4th Edition: November, 2015

5th Edition: September, 2018

6th Edition: June, 2020

Revision	Product	Added or Changed Features
1	Firmware version 1.00	New edition
2	Firmware version 1.1x	Italian, Spanish, Portuguese, Russian, and Korean have been added to the available display languages. Log input option has been added. Improvements to descriptions.
3	Ditto	Revised for DAQSTANDARD 9.03 Release
4	Firmware version 1.2x	Models with an SD card slot is released. Power monitor (/PWR5 option) is added.
5	Ditto	Additions and improvements to explanations.
6	Firmware version 1.3x	Changed the style (H:3)

How to Use This Manual

Structure of the Manual

Before reading this manual, familiarize yourself with the basic operations of this instrument by reading the **First Step Guide**. For a description of the communication function and the accompanying software program, DAQSTANDARD for FX1000, read the respective manual.

This user's manual consists of the following sections.

Chapter	Title and Contents
1	Overview of Functions Explains the features of the FX.
2	Common Operations Describes the procedure to set the time and the operating procedure using the keyboard (/USB1 option).
3	Measurement Channels and Alarms Describes how to set the measurement conditions and alarms.
4	Switching Operation Screens Describes the operations on the operation screen.
5	Operations for Changing the Displayed Contents Describes how to change the displayed contents on the operation screen and how to write messages.
6	Saving and Loading Data Describes how to acquire and store data. Also describes the procedure to load measured data/setup data on the CF card/SD card or the USB flash memory (/USB1 option).
7	Customizing Actions Using the Event Action and Remote Control Functions (/R1 and /PM1 Options) Describes how to carry out specific actions when a given event occurs, when a remote control signal is applied, and when the USER key is pressed.
8	Using the Security Function Describes how to use the key lock function and the function that allows only registered users to operate the FX.
9	Computation and Report Functions (/M1, /PM1, /PWR1, and /PWR5 options) Describes how to use computation channels and how to create reports such as hourly, daily, weekly, and monthly reports.
10	Troubleshooting Describes error messages and troubleshooting.
11	Maintenance Explains how to inspect and calibrate the FX.
12	Installation and Wiring Contains information about where to install the FX, how to install the FX, and how to wire the FX.
13	Specifications Contains the specifications of the FX.
14	Setup Items Contains the FX setting mode menu map, basic setting mode menu map, and setup items
Appendix	Describes how to estimate the file size, the types of data that the FX can generate and how to use them, the data format of text files, etc.
Index	

Note

- This user's manual covers information regarding FX1000s that have a suffix code for language "-2" (English).
- For details on setting the display language, see section 2.6, "Changing the Displayed Language."

Conventions Used in This Manual

Unit

K	Denotes 1024. Example: 768 KB (file size)
k	Denotes 1000.

Markings



Improper handling or use can lead to injury to the user or damage to the instrument. This symbol appears on the instrument to indicate that the user must refer to the user's manual for special instructions. The same symbol appears in the corresponding place in the user's manual to identify those instructions. In the manual, the symbol is used in conjunction with the word "WARNING" or "CAUTION."

WARNING

Calls attention to actions or conditions that could cause serious or fatal injury to the user, and precautions that can be taken to prevent such occurrences.

CAUTION

Calls attentions to actions or conditions that could cause light injury to the user or damage to the instrument or user's data, and precautions that can be taken to prevent such occurrences.

Note

Calls attention to information that is important for proper operation of the instrument.

Subheadings

Bold characters Denotes key or character strings that appear on the screen. Example: **Volt**



Indicates character types that can be used.
A Uppercase alphabet, a lowercase alphabet, # symbols, 1 numbers.

Procedure

Carry out the procedure according to the step numbers. All procedures are written with inexperienced users in mind; depending on the operation, not all steps need to be taken. Explanation gives information such as limitations related the procedure.

Explanation

Setup Screen

Indicates the setup screen and explains the settings. A detailed description of the function is not provided in this section. For details on the function, see chapter 1.

Setup Items

Contents

Introduction	i
How to Use This Manual	iii
Chapter 1 Overview of Functions	
1.1 Input Section	1-1
1.2 Alarms	1-5
1.3 Display	1-9
1.4 Data Storage Function	1-23
1.5 Batch Function	1-32
1.6 Event Action and Remote Control Functions (/R1 and /PM1 Options)	1-33
1.7 Security Function	1-38
1.8 Computation and Report Functions (/M1, /PM1, /PWR1, and /PWR5 Options)	1-40
1.9 FAIL/Status Output Function (/F1 Option)	1-47
1.10 Other Functions	1-49
Chapter 2 Common Operations	
2.1 Setting the Date/Time	2-1
2.2 Setting the Time Difference from GMT	2-2
2.3 Setting the Time Correction Operation during Memory Sampling	2-3
2.4 Setting the Date Format	2-4
2.5 Viewing the FX Information	2-5
2.6 Changing the Displayed Language	2-7
2.7 Setting the LCD Brightness and Backlight Saver	2-8
2.8 Initializing Settings and Clearing the Internal Memory	2-9
2.9 Using the Relay Contact to Output the FX Status (/F1 option)	2-10
2.10 Controlling the FX with a Keyboard (/USB1 option)	2-11
2.11 Using USB Flash Memory (/USB1 option)	2-13
2.12 Setting the Decimal Point Type	2-14
Chapter 3 Measurement Channels and Alarms	
3.1 Setting the Scan Interval and the Integration Time of the A/D Converter	3-1
3.2 Setting the Burnout Detection and the Reference Junction Compensation of the Thermocouple Input	3-2
3.3 Setting the Input Range	3-3
3.4 Setting the Moving Average of the Input	3-7
3.5 Setting the Auxiliary Alarm Function	3-8
3.6 Hiding the Alarm Indication	3-11
3.7 Setting Alarms on Channels	3-12
3.8 Releasing the Alarm Output (Alarm ACK Operation)	3-15
3.9 Performing Calibration Correction (/CC1 Option)	3-16
3.10 Counting Pulses (/PM1 Option)	3-17
3.11 Setting the Method of Detecting Over-Range Values of Linearly Scaled Measurement Channels	3-20
3.12 Measuring Power (/PWR1 or /PWR5 Option)	3-21
3.13 Using the Log Scale to Perform Measurements (/LG1 Option)	3-28

Chapter 4 Switching Operation Screens

4.1	Operations in Operation Mode.....	4-1
4.2	Displaying the Measured Data as Waveforms, Values, or Bar Graphs	4-4
4.3	Displaying Past Measured Data (Historical Trend Display)	4-8
4.4	Display the Statuses of All Channels on One Screen (Overview Display).....	4-16
4.5	Displaying Various Information	4-17
4.6	Using the Alarm Summary	4-19
4.7	Using the Message Summary.....	4-20
4.8	Using the Memory Summary	4-22
4.9	Displaying a List of Operation Logs	4-25
4.10	Displaying Stacked Bar Graphs (/M1, /PM1, /PWR1, and /PWR5 Options).....	4-29

Chapter 5 Operations for Changing the Displayed Contents

5.1	Setting Display Groups	5-1
5.2	Displaying Tags or Channel Numbers.....	5-3
5.3	Setting the Trend Interval and Switching to the Secondary Trend Interval.....	5-4
5.4	Writing Messages	5-6
5.5	Changing the Channel Display Colors.....	5-9
5.6	Displaying Channels in Display Zones	5-10
5.7	Displaying a Scale on the Trend Display	5-11
5.8	Displaying Alarm Point Marks and Color Scale Band on the Scale	5-14
5.9	Partially Expanding the Waveform.....	5-16
5.10	Changing the Display Layout, Clearing of the Waveform at Start, Message Display Direction, Waveform Line Width, and Grid.....	5-18
5.11	Changing the Bar Graph Display Method	5-19
5.12	Changing the Background Color of the Display	5-22
5.13	Automatically Switching Display Groups	5-23
5.14	Automatically Switching Back to the Default Display	5-24
5.15	Writing a Message When the FX Recovers from a Power Failure.....	5-25
5.16	Changing the Function menu and Display Selection Menu	5-26

Chapter 6 Saving and Loading Data

6.1	Setting the Recording Conditions of the Measured Data.....	6-1
6.2	Setting the Method for Saving the Data	6-4
6.3	Using the Batch Function.....	6-6
6.4	Starting and Stopping Recording and Saving Measured Data	6-9
6.5	Manually Saving the Measured Data (Manual Sample)	6-13
6.6	Saving the Screen Image Data (Snapshot)	6-14
6.7	Managing the Files on the External Storage Medium.....	6-15
6.8	Loading and Displaying Measured Data from External Storage Media	6-17
6.9	Saving/Loading the Setup Data	6-18

Chapter 7 Customizing Actions Using the Event Action and Remote Control Functions (/R1 and /PM1 Options)

7.1	Setting the Event Action Function (Including the remote control function of the /R1 and /PM1 options and the USER key)	7-1
7.2	Setup Examples of Event Action.....	7-5

Chapter 8 Using the Security Function		1
8.1 Disabling the Key Operation (Key Lock Function)	8-1	
8.2 Enabling Only Registered Users to Operate the FX (Login Function)	8-3	2
8.3 Logging in and Logging Out	8-6	
Chapter 9 Computation and Report Functions (/M1, /PM1, /PWR1, and /PWR5 Options)		3
9.1 Setting the Expression, Measurement Range, Alarm, Tag, and Data Storage on Computation Channels	9-1	
9.2 Writing Expressions	9-5	4
9.3 Displaying the Computation Channels	9-12	
9.4 Starting/Stopping Computation, Resetting Computation, and Releasing Computation Data Dropout Display	9-15	5
9.5 Creating Reports	9-17	
Chapter 10 Troubleshooting		6
10.1 A List of Messages	10-1	
10.2 Troubleshooting	10-17	
Chapter 11 Maintenance		7
11.1 Periodic Inspection	11-1	
11.2 Calibrating the FX	11-2	
Chapter 12 Installation and Wiring		8
12.1 Installation Location	12-1	
12.2 Installation Procedure	12-2	
12.3 External Dimensions and Panel Cut Dimensions	12-3	9
12.4 Input Signal Wiring	12-4	
12.5 Optional Terminal Wiring	12-8	
12.6 Wiring the Power Supply	12-15	10
Chapter 13 Specifications		11
13.1 Signal Input and Alarms	13-1	
13.2 Display	13-3	
13.3 Data Saving Function	13-6	
13.4 Other Standard Functions	13-8	12
13.5 Options	13-10	
13.6 General Specifications	13-17	
13.7 External Dimensions	13-21	13
Chapter 14 Setup Items		14
14.1 Setting Mode Menu Map and Setup Items	14-1	
14.2 Basic Setting Mode Menu Map and Setup Items	14-12	
Appendix		App
Appendix 1 File Size of Display Data and Event Data	App-1	
Appendix 2 Types of Data Files That the FX Can Create and How They Can Be Used	App-3	
Appendix 3 Text File Data Format	App-4	

Index

Index

1.1 Input Section

Measurement Channel

- **Number of Measurement Channels and Scan Interval**

The FX acquires data by sampling measurement channel input signals at the set scan interval. The table below shows the relationship between the number of measurement channels and the scan interval

Model	Number of Measurement Channels	Scan Interval	A/D Converter Integration Time
FX1002	2	125ms, 250ms	AUTO ¹ /50Hz/60Hz
FX1004	4		
FX1006	6	1s, 2s, 5s	AUTO ¹ /50Hz/60Hz/ 100ms ²
FX1008	8		
FX1010	10		
FX1012	12		

1 AUTO: The FX automatically switches between 50 Hz and 60 Hz depending on the power supply frequency.

2 You can only set the integration time to 100 ms on models FX1006 through FX1012.

If you set the integration time to 100 ms, you can only set the scan interval to 2 seconds or 5 seconds.

For the setting procedure, see section 3.1.

- **Integration Time of the A/D Converter**

The FX uses an A/D converter to convert sampled analog signals to digital signals.

By setting the integration time of the A/D converter to match the time period corresponding to one cycle of the power supply or an integer multiple of one cycle, the power supply frequency noise can be effectively eliminated.

- Because 100 ms is an integer multiple of 16.7 ms and 20 ms, this setting can be used to eliminate the power frequency noise for both frequencies, 50 Hz and 60 Hz.

For the setting procedure, see section 3.1.

Input Type and Computation

You can make measurements using the following input types.

Input Type	Description
DC voltage	You can measure DC voltages in the range of ± 20 mV to ± 50 V.
DC current	You can measure a DC current signal by converting it to a voltage signal using a shunt ¹ resistor attached to the input terminal. The converted signal can be measured within the DC voltage range (see above).
Thermocouple	You can measure temperatures corresponding to these thermocouple types: R, S, B, K, E, J, T, N, W, L, U, and WRe3-25. It is also possible to measure using other thermocouples, such as PR40-20 and PLATINEL. ²
RTD	You can measure temperatures using RTD types Pt100 and JPt100. It is also possible to measure using other RTD types such as Pt50 and Ni100. ²
ON/OFF input	You can display contact input or voltage input signals correlated to 0% or 100% of the display range. Contact input: A closed contact is on (1). An open contact is off (0). Voltage input: Less than 2.4 V is off (0). 2.4 V or more is on (1).
Pulse input ³	You can count pulses. Use the dedicated input terminal.
AC voltage and current ⁴	You can measure the power and electric energy. Use the dedicated input terminal.
Logarithmic DC voltage ⁵	Use the Log scale to display and record the physical quantity.

1 Item sold separately. For example, you can use a 250 Ω shunt resistor to convert a 4 to 20 mA signal to a 1 to 5 V signal.

2 /N3F option

3 /PM1 option

4 /PWR1 or /PWR5 option

5 /LG1 option

1.1 Input Section

The following input processing and computation are available.

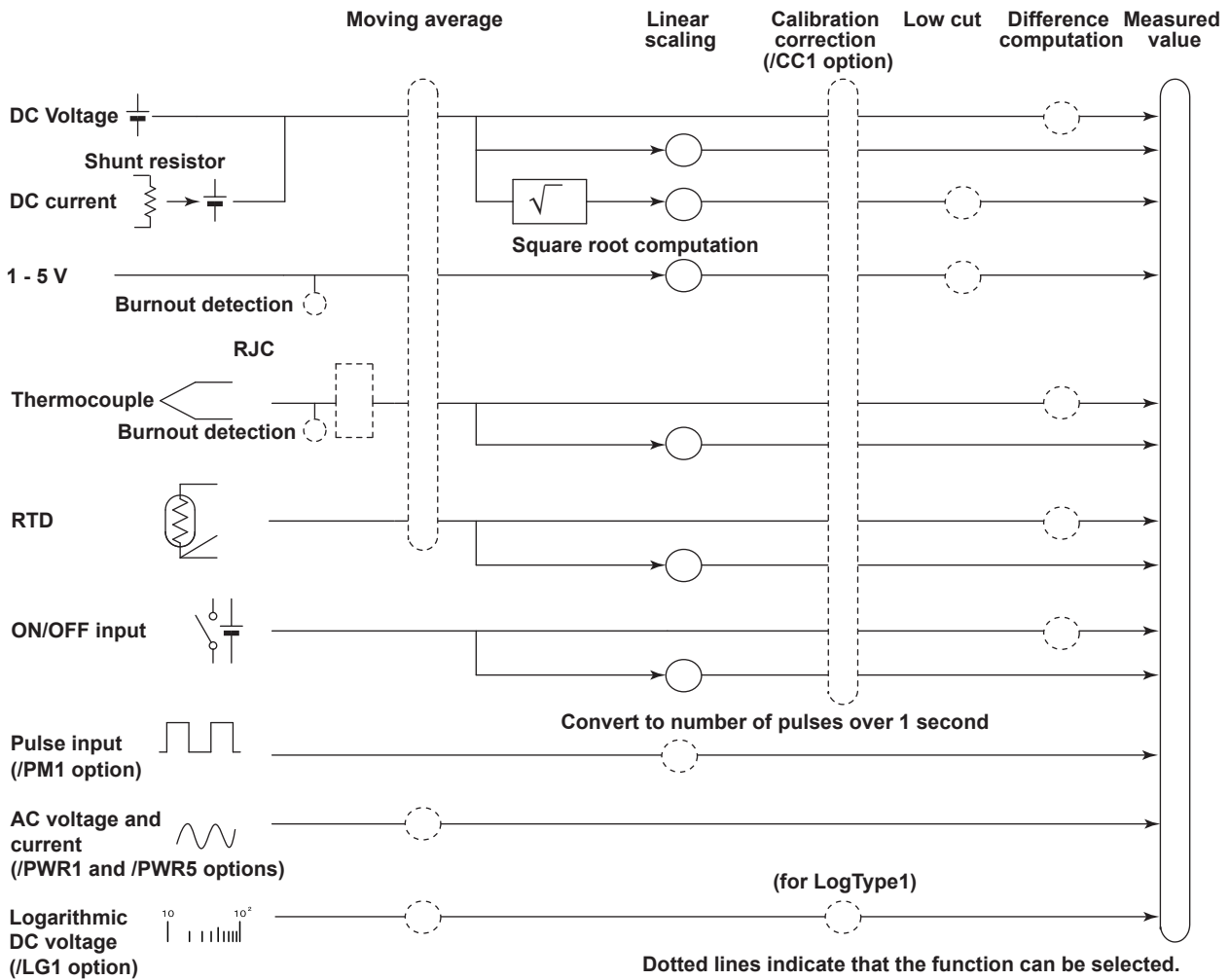

Reference Junction Compensation	Burnout Detection
<p>Performs reference junction compensation on the thermocouple.</p> <p>For the setting procedure, see section 3.2.</p>	<p>Detects and indicates a burnout in the sensor.</p> <p>Burnout</p> <p>1 - 5 V Detected on the 1-5 V value.</p> <p>Burnout</p> <p>Thermoelectromotive force</p> <p>For the setting procedure, see section 3.2.</p>
Moving Average	
<p>Eliminates noise.</p> <p>Operation example when the number of moving average data points is 3</p> <p>Number of moving average data points: 2 to 400</p> <p>For the setting procedure, see section 3.4.</p>	

<p align="center">Square Root Computation</p> <p>Takes the square root of the input value and converts the unit to obtain the measured value.</p> $X = (B - A) \sqrt{\frac{x - a}{b - a}} + A$ <p>For the setting procedure, see section 3.3.</p>	<p align="center">Linear Scaling</p> <p>Converts the unit to obtain the measured value.</p> <p>For the setting procedure, see section 3.3.</p>
<p align="center">Calibration Correction (/CC1 Option)</p> <p>Corrects the input value with the characteristics specified by segments to obtain the measured value.</p> <p>For the setting procedure, see section 3.9.</p>	<p align="center">Low-cut</p> <p>For square root computation, measured values below the specified value are cut. For 1-5 V input, values below 0 % are cut.</p> <p>For the setting procedure, see section 3.3.</p>
<p align="center">Difference computation</p> <p>The measured value of the channel is set to the difference with respect to the measured value of the reference channel</p> <p>For the setting procedure, see section 3.3.</p>	<p align="center">Pulse Input (/PM1 Option)</p> <p>Counts the pulses. Use the computation channels (/M1, /PM1, /PWR1, and /PWR5 options). Pulse that can be counted FX input</p> <p>Counted on the FX The contact changes from open to close. The signal level at the input terminal changes from high to low.</p> <p>For the setting procedure, see section 3.10.</p>
<p align="center">AC Voltage and Current (/PWR1 and /PWR5 options)</p> <p>Measure the measurement elements of electrical power. Use the computation channels (/M1, /PM1, /PWR1, and /PWR5 options).</p> <p>For the setting procedure, see section 3.12.</p>	<p align="center">Logarithmic DC Voltage (/LG1 option)</p> <p>You can apply a logarithmic voltage that has been converted from a physical value to the FX, and then use the FX's Log scale (logarithmic scale) to display and record the physical value.</p> <p>For the setting procedure, see section 3.13.</p>

Note

Difference computation is executed even if the input type or range is not the same between the difference computation channel and the reference channel. The difference is computed discarding the decimal place and unit, and the decimal place and unit of the difference computation channel are applied.

Example 1: If the input value of the difference computation channel is 10.00 and the measured value of the reference channel is 100.0, the computed result is
 $10.00 - 100.0 = -90.00$.

Example 2: If the input value of the difference computation channel is 10.00 V and the measured value of the reference channel is 5.00 mV, the computed result is
 $10.00 \text{ V} - 5.00 \text{ mV} = 5.00 \text{ V}$.

1.2 Alarms

This function generates an alarm when the measured data meets a certain condition. Up to four alarms can be set for each channel.

Alarm Type

You can use the alarms shown below. The character inside the parentheses is the symbol denoting each alarm.

For the alarm setting procedure, see section 3.7.

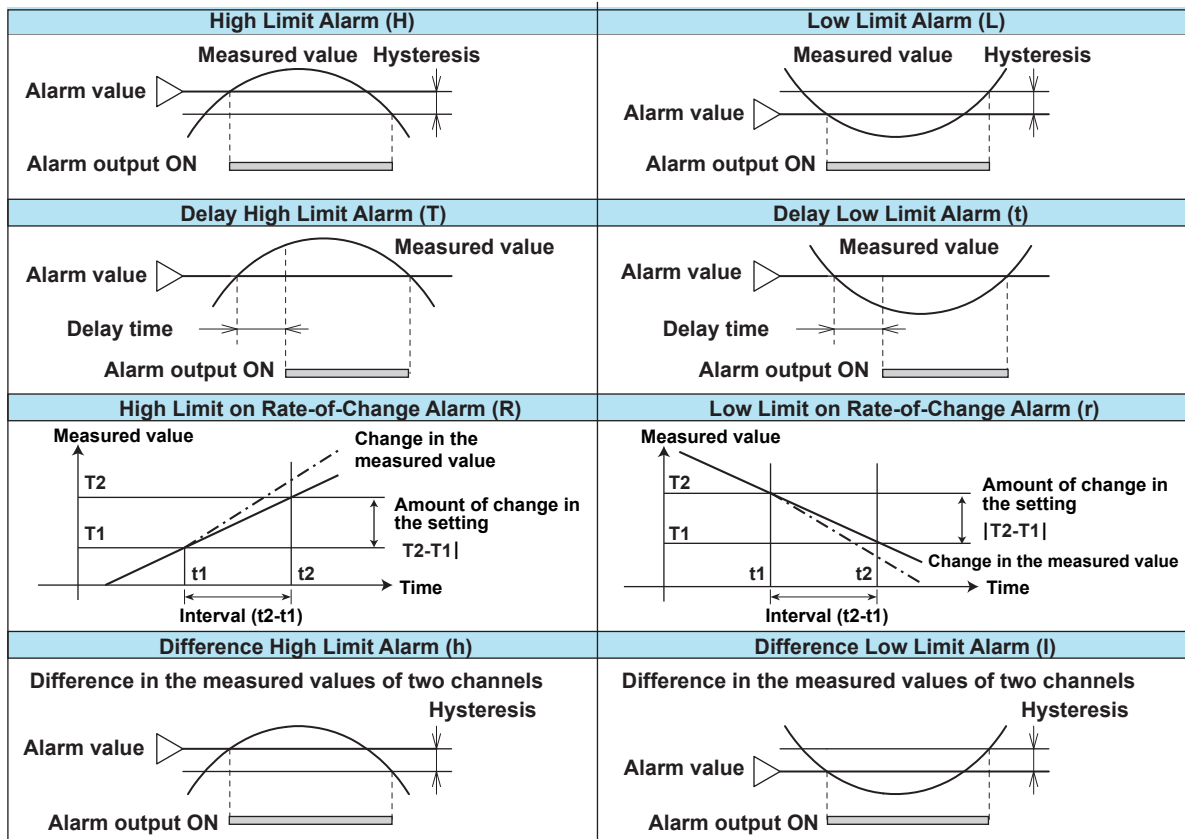

- **Alarm Hysteresis**

You can set a width (hysteresis) to the value used to activate and release alarms. For the setting procedure, see section 3.5.

- **Delay High Limit Alarm and Delay Low Limit Alarm**

An alarm occurs when the measured value remains above or below the alarm value for a specified time period (delay time).

- **High Limit on Rate-of-Change Alarm and Low Limit on Rate-of-Change Alarm**

The rate-of-change of the measured values is checked over a certain time (interval). An alarm occurs if the rate-of-change of the measured value in the rising/falling direction is greater than or equal to the specified value.

The alarm value of the rate-of-change alarm is set using an absolute value. The interval is derived using the following equation and set using the number of samples.

$$\text{Interval} = \text{the scan interval} \times \text{the number of samples}$$

For the setting procedure, see section 3.5.

- **Difference High Limit Alarm and Difference Low Limit Alarm**

An alarm occurs when the difference in the measured values of two channels is greater/less than or equal to the specified value. These alarms can be specified on measurement channels set to difference computation.

Alarm Indication

The alarm conditions are displayed as alarm icons in the status display section and on the operation screen such as the trend, digital, bar graph, overview displays. Detailed information about the alarms is displayed in the alarm summary.

- **Hold/Non-hold of Indications**

The alarm indication can be set to operate in the following fashion when the condition is no longer met.

- Clear the alarm indication (non-hold).
- Hold the alarm indication until the alarm ACK operation is executed (hold).

The default setting is non-hold.

For the setting procedure, see section 3.5.

- **Alarm Hide Function**

No indication is made when an alarm occurs. The alarm is also not recorded in the alarm summary. However, the FX will output alarm information to the relay (/A[] and /A4A options) or internal switch. This function can be set for each channel and each alarm.

For the setting procedure, see section 3.6.

Alarm Output Relay Operation

The FX can generate a contact signal from an alarm output relay (/A[] and /A4A options) when an alarm occurs. The alarm output relay operation can be changed. For the setting procedure, see section 3.5.

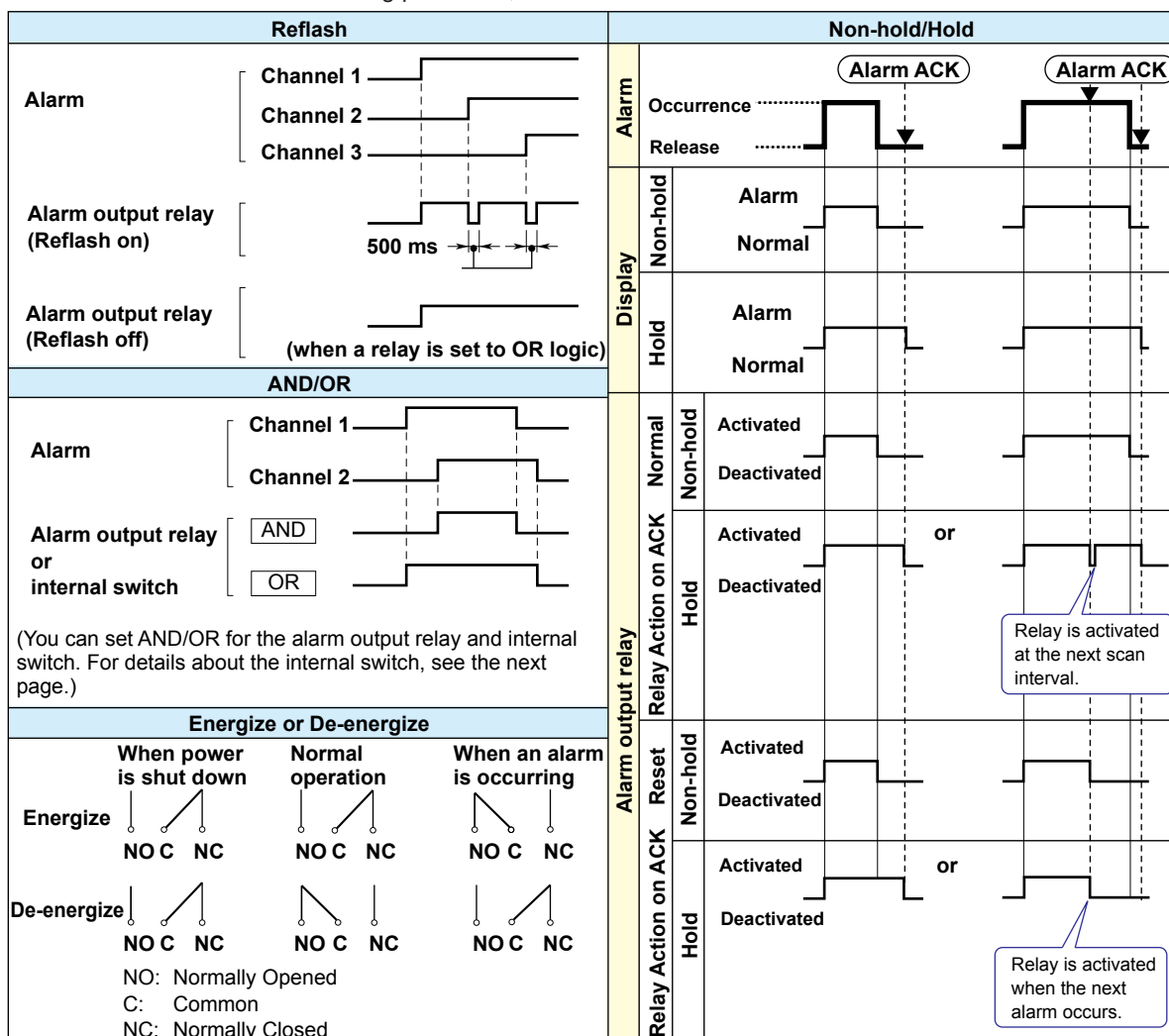

• **Reflash**

When multiple alarms are assigned to one alarm output relay, this function notifies the occurrence of subsequent alarms after the relay is activated by the first alarm. When subsequent alarms occur, the output relay is released temporarily. The relays are deactivated for 500 ms.

The reflash function is set on the first three output relays*.

* I01 to I03. I01 and I02 for the /A1 option.

Note

When reflash is enabled, the first three output relays are used exclusively as reflash relays. The first three output relays are set to OR logic and non-hold operation regardless of the AND/OR and non-hold/hold settings explained below.

• **AND/OR**

When multiple alarms are assigned to one alarm output relay, the condition for activating the output relay can be selected from the following: You can select AND operation also for the internal switch.

- AND: Activated when all assigned alarms are occurring simultaneously.
- OR: Activated when any of the specified alarms is occurring.

- **Energize or De-energize Operation**

You can select whether the alarm output relay is energized or de-energized when an alarm occurs. If you select de-energize, the alarm output relays will be in the same state when the power is shut off as they are when an alarm occurs. The setting applies to all alarm output relays.

- **Non-Hold/Hold**

The alarm output relay can be set to operate in the following fashion when the alarm condition is no longer met.

- Turn OFF the relay output (non-hold).
- Hold the relay at ON until the alarm ACK operation is executed (hold).

The setting applies to all alarm output relays.

- **Alarm ACK Operation**

The alarm acknowledge (alarm ACK) operation releases all alarm indications and relay outputs. For the action of alarm indication and alarm output relay when you carried out the alarm ACK operation, see the previous page.

Note

When you enter the basic setting mode, the hold/non-hold condition of the alarm output relay immediately before is retained. In the basic setting mode, alarms are not detected, and you cannot acknowledge alarms.

Internal Switch

The alarm status can be output to software switches (30 internal switches). The values of the internal switch are shown below. Like the alarm output relay, you can specify AND/ OR operation (see the previous page). The internal switches cannot be operated other than for alarm output.

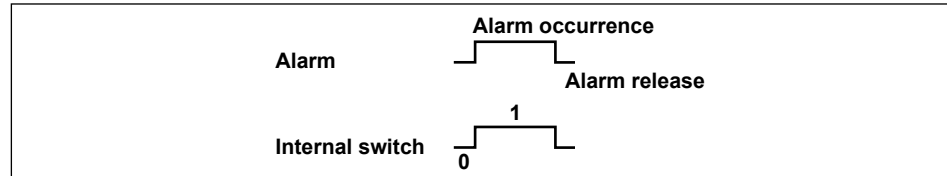

The internal switches can be used events of the event action function (see section 1.6). Internal switches can also be written into computation channel (/M1, /PM1, /PWR1, and /PWR5 options) equations.

1.3 Display

This section will explain the FX display.

Common Items Related to the Display

- **5.7-Inch Color LCD and Parts of the Display**

The FX has a 5.7-inch TFT color LCD (240 × 320 dot resolution). The screen consists of the status display section and the data display section.

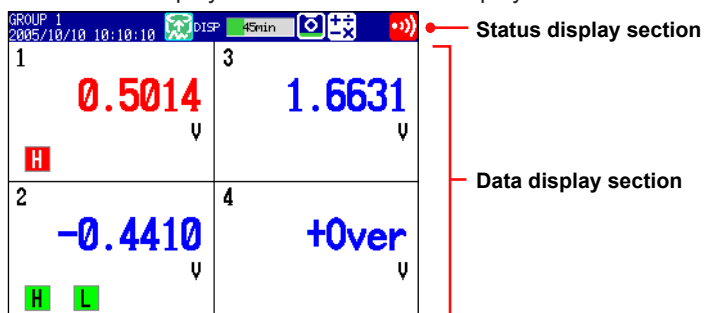

Status Display Section

The status display section indicates the display name, date/time, batch name (when using the batch function), user name (when using the login function), internal memory usage, and CF card/SD card (when the FX is equipped with a CF card slot/SD card slot) usage, alarm occurrence, computation status (/M1, /PM1, /PWR1, or /PWR5 option), key lock status, and e-mail transmission (/C7 option).

Data Display Section

The data display section shows the measured data using numeric values, waveforms, and bar graphs. It also shows the setup screen when setting functions.

- **Group Display**

On the trend, digital, and bar graph displays, the data of channels is displayed by groups that are set in advance. Up to 10 groups can be registered, and up to six channels can be assigned to each group. Groups are common to the trend, digital, and bar graph displays.

The displayed group can be switched automatically at a specified time interval (5 s to 1 min).

For the setting procedure, see section 5.1.

- **Channel Number Display and Tag Display**

You can choose to label displayed channels according to their tags or according to their channel numbers. This setting applies to all channels.

For the setting procedure, see section 5.2.

- **Update Interval of Measured Values**

The values are updated every second. However, if the scan interval is greater than 1 s, the values are updated at the scan interval.

For the setting procedure, see section 5.3.

- **Alarm Indication**

Alarms that are set for each channel are checked at all times and are indicated with the symbol representing the alarm type on each display.

Alarm Type	Symbol	Alarm Type	Symbol
High limit alarm	H	High limit on rate-of-change alarm	R
Low limit alarm	L	Low limit on rate-of-change alarm	r
Difference high limit alarm	h	Delay high limit alarm	T
Difference low limit alarm	l	Delay low limit alarm	t

Status Display Section

The following information is displayed in the status display section during operation mode or setting mode.





Memory sampling status

Memory sampling stopped  **Data type**
DISP: Display data
EVENT: Event data

Memory sampling in progress  **Memory sampling progress**
 Displays the progress using a green bar graph. The frame indicates the file save interval (display data) or the data length (event data).

Memory sampling icon  **Error in internal memory.**
 Contact your nearest YOKOGAWA dealer.

50min  **Displays the remaining memory sampling time for the left bar graph.**

GROUP 1 **ALL** **2005/12/01 14:21:30**  **DISP** **50min**    

Display name or group name
 For all channel display on the trend display, "All" is displayed.

Date and time
 Displayed in yellow while the time is being corrected.



When using the batch function
AAA-1234-000541 **2005/12/01 14:21:26**
Batch name and the display name are shown alternately.
Date and time
 If the "batch number-lot number" exceeds 20 characters, the "date and time" position is used to display the "batch number-lot number."



When using the login function
Admin1 **2005/12/01 14:24:01**
Name of the user logged in
Date and time and the display name are shown alternately.





When using the login and batch functions
Admin1 **AAA-1234-000542**
Name of the user logged in
Batch name, the display name, and date and time are shown alternately.

Alarm icon
 Displayed when any alarm is activated. Blinks when there are alarms that are occurring but have not been acknowledged. (Red)

 All alarms have been released after they have occurred, but there are alarms that have not been acknowledged. (Green)

Status icon
 Keys are locked.
 E-mail transmission (/C7 option) is enabled.
 The status assigned to the status output (/F1 option) is occurring.

Computation icon (/M1, /PM1, /PWR1, and /PWR5 options)
 White icon: Computation started
 Yellow icon: Computation data dropout occurred
 Red icon: Error in the power measurement section

CF card/SD card icon (on FXs that have a card slot)
 CF card/SD card is being accessed.  Waiting.
 Light blue icon: CF card/SD card in the slot is not recognized. Remove and reset it.
 CF card/SD card error.
 Carry out the procedure described on the left to reset the CF card/SD card icon to normal.

The green level display indicates the amount of CF card/SD card used. If Media FIFO^{*1} is not enabled and the free space on the card falls below 10%, the level indicator changes to red.

^{*1} See section 1.4.

- Remove the CF card/SD card, and then reinsert it.
- Replace the CF card/SD card with a normal one.
- Format^{*2} the CF card/SD card (the CF card/SD card data will be deleted).

^{*2} You cannot format a SD card on the FX. See section 6.7.

Bar Graph

When event data recording is set to pretrigger, the FX will start recording pretrigger data after you press the START key. "Waiting" appears in the bar graph. At this time, the progress bar will turn orange. After the pretrigger time elapses, the length of the bar fixed at that point. However, the relevant data is updated until the trigger condition is met. When the trigger condition is met, the bar turns green, and data is recorded after the data in the pretrigger section.

Trend Display (T-Y)

Measured data is displayed in a waveform. For the operating procedure, see section 4.2.

Trend Space function
Inserts a division-wide space here.
See section 4.2

Current value mark

Scale
See section 5.7

Trend interval
See section 5.3

Grid
See section 5.10

Trip line (up to four lines)
See section 5.1

Numeric display section
See section 4.2

Tag or channel number, measured value, unit, and specified alarm

Waveform (displayed with the set channel color)
To change channel colors, see section 5.5.
To change waveform line width, see section 5.10.
To display every channel's waveform, see section 4.2.

Time at the grid position
Either displays the time, or the date and time.
See sections 2.4 and 5.3

1 division (30 dots)

Minimum value 1 dot

Maximum value

Displays the maximum and minimum values sampled in the time corresponding to one dot.

Display layout See section 5.10

Horizontal display

1	0.3816	V
2	1.0959	V
3	1.3121	V
4	1.6580	V

Horizontal wide display

1	0.2610	V
2	0.9566	V
3	1.2175	V
4	1.5867	V

Color scale band
See section 5.8

Current value indicated by bar
See section 5.7

Alarm point mark
See section 5.8

Alarm type

Alarm mark

1.3 Display

- **Updating of the Waveform**

On the screen, 30 dots along the time axis is represented by a unit called division (see the figure on the previous page). The displayed waveform is updated at an interval corresponding to one dot. This interval is determined by the time corresponding to one division (referred to as the trend interval). The relationship between the trend interval and the speed of movement of waveforms on the screen is as follows:

Trend interval (/DIV)	15 s¹	30 s	1 min	2 min	5 min
Time corresponding to one dot (in seconds)	0.5	1	2	4	10
Speed of waveform movement (approximation in mm/h)	2500	1250	625	312	156
Trend interval (/DIV)	10 min	15 min	20 min	30 min	1 h
Time corresponding to one dot (in seconds)	20	30	40	60	120
Speed of waveform movement (approximation in mm/h)	78	42	31	21	10
Trend interval (/DIV)	2 h	4 h	10 h		
Time corresponding to one dot (in seconds)	240	480	1200		
Speed of waveform movement (approximation in mm/h)	5.2	2.6	1.0		

1 Selectable on the FX1002 and FX1004

Switching the Trend Interval

You can switch from the normal trend interval to the secondary trend interval during memory sampling and vice versa. For the operating procedure, see section 5.3.

- **Writing Messages**

Preset messages

1	Start
2	Material 1
3	
4	

Trend display

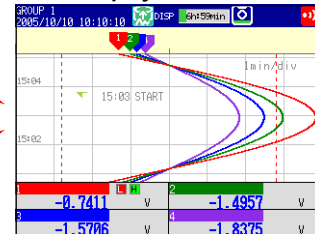

Free message

Set the message when writing the message

Preset Messages

Preset messages are recalled and written.

The number of messages that you can use are 100 (message 1 to 10 are shared with free messages). For the operating procedure, see section 5.4.

Free Messages

Messages are entered when you need to enter them. The number of messages that you can use are 10. For the operating procedure, see section 5.4.

Automatic Message Writing

- A message is written when the trend interval is switched during memory sampling. For the setting procedure, see section 5.3.
- A message is written when the power recovers from a power failure during memory sampling. For the setting procedure, see sections 5.3 and 5.15.

Message display method

- Except for the vertical display, you can set the direction in which messages are displayed to horizontal or vertical. For the setting procedure, see section 5.10.
- Messages can be displayed consolidated at the upper left of the screen (list display). For the operating procedure, see section 4.2.

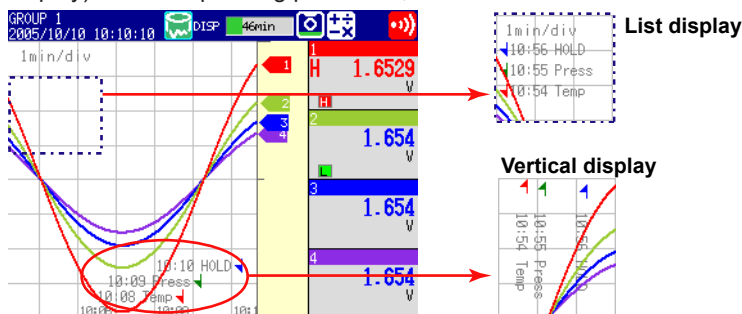

• Zone Display

You can display channels in specified zones. This function can be used to keep the waveforms from overlapping for easier view.

In the example below, channel 1 is displayed in the 0 to 30% zone, channel 2 in the 30 to 60% zone, and channel 3 in the 60 to 100% zone.

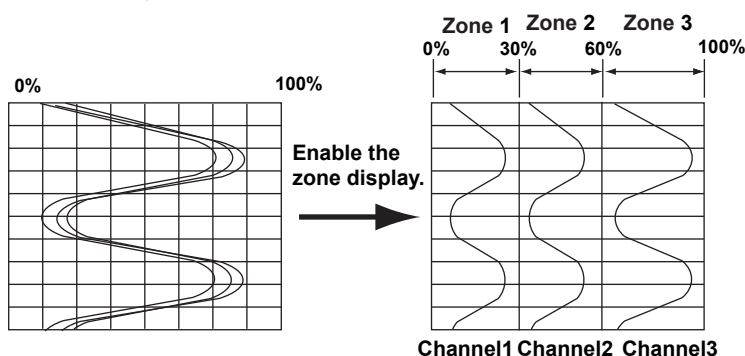

For the setting procedure, see section 5.6.

• Partial Expanded Display

By compressing a section of the waveform display range, the rest of the section is expanded.

In the example below, 0 V (boundary value) is moved to the 30% position of the display range (new boundary position). The 30% area below the boundary corresponds to “- 6 V to 0 V” and 70% area above the boundary corresponds to “0 V to 6 V.”

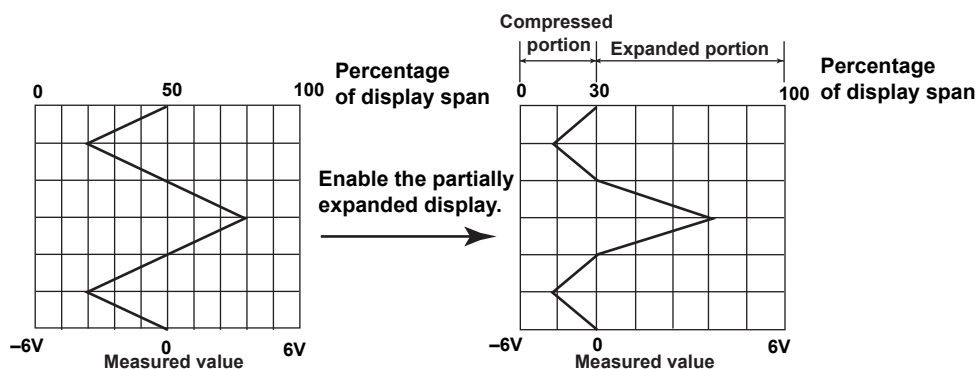

For the setting procedure, see section 5.9.

1.3 Display

- **Alarm Indication**

Alarm mark, alarm type, and measured value are displayed as follows according to the alarm status.

Alarm	Occurrence Release	When indication is set to non-hold				When indication is set to hold					
		Alarm ACK		AlarmACK		Alarm ACK		AlarmACK			
Alarm mark	Green	Red	Green	Green	Blinking red	Blinking green	Green	Green	Blinking red	Red	Green
Alarm type	None	Red	None	None	Red	None	None	None	Red	Red	None
Measured value	Blue	Red	Blue	Blue	Red	Blue	Blue	Blue	Red	Red	Blue

Digital Display

Displays the measured data numerically using large numbers. For the operating procedure, see section 4.2.

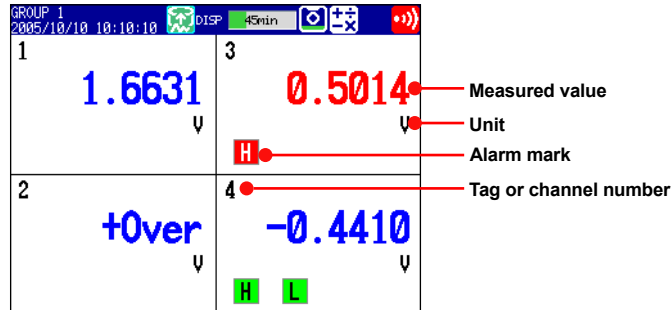

Note

- **Numeric display of measurement channels**

If a measured value of a measurement channel is over range (see below), the measured value is indicated as “+Over” or “–Over.” If a burnout is detected on a channel whose burnout detection function is enabled, the word “Burnout” is indicated. Otherwise, a numeric value is displayed.

Over range of measurement channels

- For DC voltage input, over range occurs when the measured value of the measurement channel exceeds $\pm 5\%$ of the measurable range. For example, the measurable range when the measurement range is 2 V is -2.000 to 2.000 V. If the measured value exceeds 2.200 V, + over range occurs; if the measured value falls below -2.200 V, – over range occurs.
- For thermocouple or RTD input, over range occurs when the measured value exceeds approximately $\pm 10^\circ\text{C}$ of the measurable range. For example, the measurable range when the measurement range is R is 0.0 to 1760.0°C . If the measured value exceeds approximately 1770.0°C , + over range occurs; if the measured value falls below approximately -10.0°C , – over range occurs.
- For channels that are linearly scaled, + over range occurs when the value exceeds 30000 excluding the decimal point; – over range occurs when the value falls below -30000 . However, + over range can be changed to greater than or equal to 105% of the scale width and – over range to less than or equal to -5% of the scale width within ± 30000 . For the setting procedure, see section 3.11.

- **Numeric display of computation channels**

See section 1.8, “Computation and Report Functions (/M1, /PM1, /PWR1, and /PWR5 options).”

• **Alarm Indication**

The alarm mark and measured values are displayed in the following ways depending on the alarm status.

Alarm	When indication is set to non-hold				When indication is set to hold						
	Occurrence	Release	Alarm ACK	Alarm ACK	Alarm ACK	Alarm ACK	Alarm ACK	Alarm ACK			
Alarm mark	Green	Red	Green	Green	Blinking red	Blinking green	Green	Green	Blinking red	Red	Green
Measured value	Blue	Red	Blue	Blue	Red	Blue	Blue	Blue	Red	Red	Blue

Bar Graph Display

Waveform data is displayed in a bar graph. For the operating procedure, see section 4.2.

Vertical

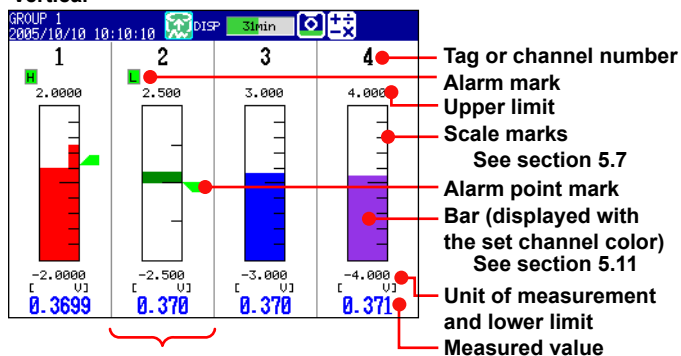

Bar graph base position is set to Center. See section 5.11

Horizontal See section 5.10

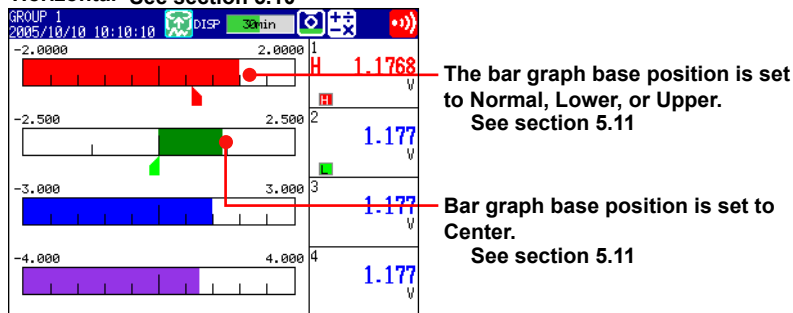

• **Updating of the Bar Graph**

The bar graph is updated at the same interval as numeric values.

• **Alarm Indication**

The alarm mark, alarm point mark,¹ and measured values are displayed in the following ways, depending on the alarm status.

Alarm	When indication is set to non-hold				When indication is set to hold						
	Occurrence	Release	Alarm ACK	Alarm ACK	Alarm ACK	Alarm ACK	Alarm ACK	Alarm ACK			
Alarm mark	Green	Red	Green	Green	Blinking red	Blinking green	Green	Green	Blinking red	Red	Green
Point mark ¹	Green	Red	Green	Green	Red	Green	Green	Green	Red	Red	Green
Measured value	Blue	Red	Blue	Blue	Red	Blue	Blue	Blue	Red	Red	Blue

¹ Displayed when you are configuring alarms

Historical Trend Display

The waveform of the past measured data (display or event data) in the internal memory or external storage medium can be displayed. This function is called *Historical trend*.

• Methods of Displaying the Historical Trend

There are four methods to display the historical trend of the measured data in the internal memory.

- Display from the alarm summary. For the operating procedure, see section 4.6.
- Display from the message summary. For the operating procedure, see section 4.7.
- Display from the memory summary. For the operating procedure, see section 4.8.
- Recall from the display selection menu. For the operating procedure, see section 4.3.

Measured data on an external storage medium can also be displayed as historical trend. For the operating procedure, see section 6.8.

• Displayed Contents

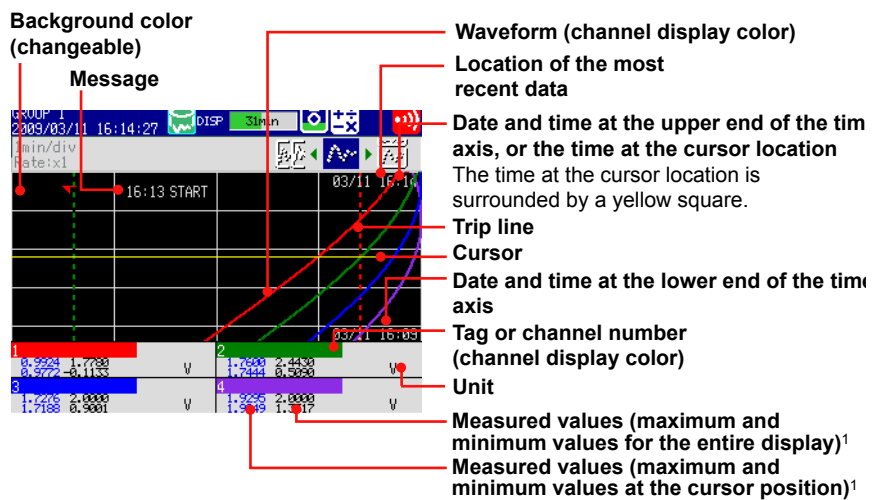

¹ You can also display only the digital value of the cursor position (the maximum value at the cursor position).

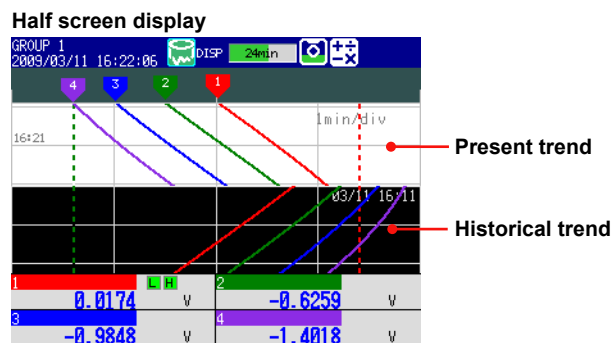

Item	Description
Alarm summary	Displays an alarm summary of the displayed data.
Message summary	Displays a message summary of the displayed data.
Memory information	Displays the properties (such as the file name, start time, and end time) of the displayed data.

• Added Messages

Added messages can be written. For the operating procedure, see section 5.4.

Overview Display

Displays a list of the statuses of all channels.

You can move the cursor to select a channel and display the trend, digital, or bar graph of the group containing the selected channel.

For the operating procedure, see section 4.4.

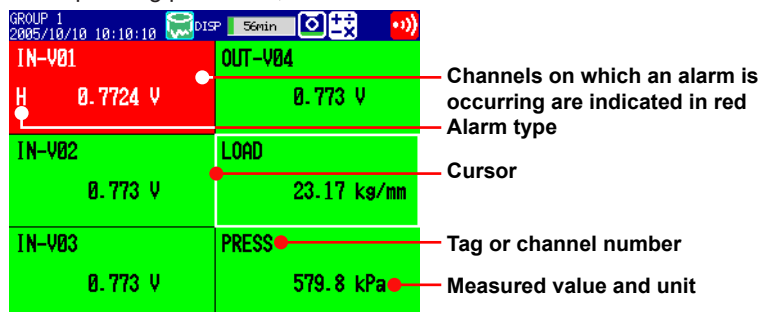

- **Alarm Indication**

The channel display area, channel number or tag name, alarm type, and measured value are displayed in the following ways, depending on the alarm status.

Alarm	When indication is set to non-hold				When indication is set to hold						
	Occurrence	Release	Alarm ACK	Alarm ACK	Alarm ACK	Alarm ACK	Alarm ACK	Alarm ACK	Alarm ACK	Alarm ACK	Alarm ACK
Tag/Channel	Black	White	Black	Black	Blinking white	Blinking black	Black	Black	Blinking white	White	Black
Channel area	Green	Red	Green	Green	Red	Green	Green	Green	Red	Red	Green
Alarm type	None	White	None	None	White	None	None	None	White	White	None
Measured value	Black	White	Black	Black	White	Black	Black	Black	White	White	Black

Alarm Summary

Displays a list of the most recent alarms.

- Up to 1000 alarms can be displayed.
- You can select arbitrary alarm information and recall the historical trend of the display data or event data that contains the alarm information.

For the setting procedure, see section 4.6.

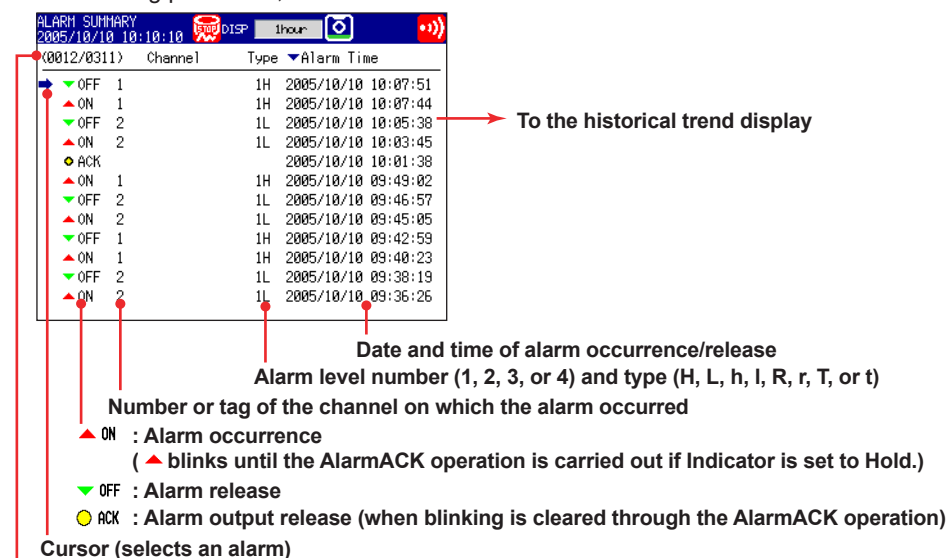

The number of the alarm information entry displayed on the screen's bottom line and the number of alarm information entries in internal memory

Message Summary

Displays a list of written messages and the time the messages were written.

- Up to 450 messages can be displayed.
- Up to 50 messages that are added to the past data section (added messages) can be displayed.
- You can select arbitrary message information and recall the historical trend of the display data or event data that contains the message.

For the setting procedure, see section 4.7.

Message	Time	Grp
POWER OFF	05/10/10 10:09	1
STOP	05/10/10 10:08	A
DANGER	05/10/10 10:06	A
BATTERY	05/10/10 10:03	2
POWER ON	05/10/10 10:02	A
HIGH VOLTAGE	05/10/10 10:01	A

Message Added message (displayed in blue)

Cursor (selects the message)

Date/Time when the message was written

Destination group to write the message All groups "A" or a group number, or the second of the date/time when the message was written.

To the historical trend display

The number of the message data displayed on the screen's bottom line and the number of messages in internal memory

- **Switching of the Display Items**

You can switch between two sets of display contents.

- Message, time when the message was written, and group to which the message was written or second of the time when the message was written
- Message, user name that wrote the message

Memory Summary

Displays the information pertaining to the display data and event data in the internal memory.

- By selecting the display data or event data, the historical trend display can be recalled.
- The FX displays the number of manually sampled data samples and report data samples (/M1, /PM1, /PWR1, and /PWR5 options) in internal memory.

For the operating procedure, see section 4.8.

The screenshot shows the MEMORY SUMMARY screen with the following data table:

Start Time	End Time	Data	Factor
10/10 10:07:56	10/10 10:08:12	5	Samplins
10/10 10:03:04	10/10 10:04:48	327	Stop
10/10 10:02:20	10/10 10:02:36	5	Stop
10/10 10:00:24	10/10 10:01:24	16	Stop
10/10 09:58:20	10/10 09:59:32	19	Stop
10/09 20:09:08	10/09 20:25:52	252	Stop
10/09 19:09:08	10/09 20:09:04	900	Auto Save
10/09 18:09:08	10/09 19:09:04	900	Auto Save
10/09 17:09:08	10/09 18:09:04	900	Auto Save
10/09 16:16:52	10/09 17:07:16	757	Stop
10/09 16:01:00	10/09 16:06:04	77	Stop
10/09 09:02:48	10/09 09:43:52	617	Stop

Annotations and labels in the image:

- Date/Time of the most recent data**: Points to the top right of the table.
- Number of data points in the internal memory/maximum number of data points that can be recorded in the internal memory**: Points to the top right of the table.
- Data type**:
 - Display data
 - Event data
- To the historical trend display**: Points to the 'Stop' status in the Factor column.
- Status**: Points to the Factor column.
- Sampling count**: Points to the Data column.
- Date/Time of memory stop**: Points to the End Time column.
- Date/Time of memory start**: Points to the Start Time column.
- Cursor (selects the file)**: Points to the blue arrow cursor on the first row.

- **Switching of the Display Items**

You can switch between two sets of displayed items.

- Display the start and end times
- Display the file name

- **Saving the Data**

The data in the internal memory can be saved to a CF card/SD card or USB flash memory (/USB1 option).

Report Data (/M1, /PM1, /PWR1, and /PWR5 options)

Report data residing in the internal memory can be displayed.
 For the operating procedure, see section 4.5.

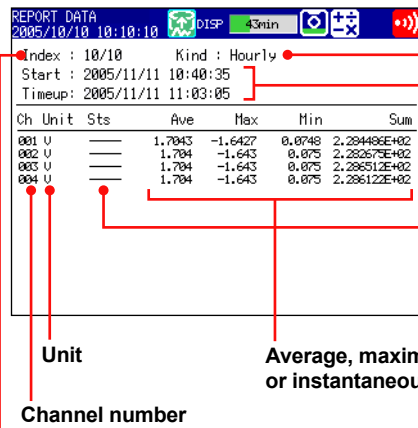

Report type
Start: Start date/time
Timeup: Report date/time

Report data status
 Indicates that the following occurred between the report interval.
E: Error data
O: Over data
P: Power failure
C: Time change
B: Burnout

Number of the displayed report data/number of report data in the internal memory

Stacked Bar Graph (/M1, /PM1, /PWR1, and /PWR5 options)

You can display the report data (that is stored in the internal memory) of each report group in a stacked bar graph.
 For operating instructions, see section 4.10.
 For information about report groups, see section 9.5.

• **Types of Displayed Data**

The type of displayed data is determined by the report kind, which is set using the report function.

Report Kind	Displayed Report Data
Hour, H + D	Sums for each hour and sums for the day
Day + Week	Sums for each day and sums for the week
Day, D + M	Sums for each day and sums for the month

Example: Hourly + daily display

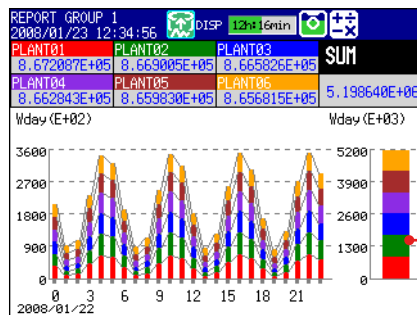

Daily sums of each channel and the daily sums of all channels of the report group
 If you select a bar graph, the sum of the hour selected with the cursor is displayed.

Sums for the day (bar graph) of a report group

Hourly report group sums (bar graph)

- **Display Modes**

You can switch the bar graph between single graph and dual graph display.

Single graph display

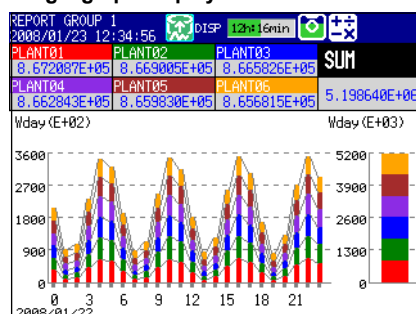

Dual graph display (Shows the data from two consecutive periods)

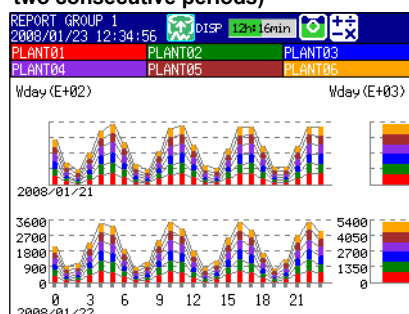

Status Display

The following displays are available.

For the operating procedure, see section 4.5.

- **Relay Status Display**

Displays the status of the alarm output relay and internal switch.

- **Modbus Client Status Display (/C7 option) and Modbus Master Status Display (/C2 and /C3 options)**

Display the command status.

Log Display

Displays various logs (operation log).

For the operating procedure, see section 4.9.

Log Type	Description
Login	Log of login/logout, log of time setting, and log of power failure
Error	Log of error messages
Communication ¹	Log of communication commands
FTP transfer ²	Log of FTP transfers
WEB ²	Log of Web operations
E-mail transmission ²	Log of e-mail transmissions
SNTTP ²	Log of accesses to the SNTTP server
DHCP ²	Log of DHCP server access
MODBUS ¹	Log of communications using Modbus client or Modbus master

¹ /C2, /C3, and /C7 options

² /C7 option

Other Useful Functions

- **Automatically Reverting to the Specified Display**

Show a preset display when there is no operation for a specific time.

For the setting procedure, see section 5.14.

- **Customizing the Menus**

You can change the contents of the Function menu, which is displayed when you press FUNC, and the display selection menu, which is displayed when you press DISP/ENTER.

For the setting procedure, see section 5.16.

Setting the Display Conditions of the LCD

The display conditions of the LCD can be configured.

Display Attribute	Setting
Background color of the operation display	The background color of the display can be set to white or black. The default value is White . For the setting procedure, see section 5.12.
Background color of the historical trend screen	You can select white, cream, black, or light gray for the background color of the screen. The default value is Black . For the setting procedure, see section 5.12.
LCD brightness	The brightness of the LCD can be set among eight levels. The default brightness is 2 . For the setting procedure, see section 2.7.
Backlight saver	The lifetime of the LCD backlight can be extended by automatically turning OFF or dimming the light when there is no key operation for a specified amount of time. The display returns to the original brightness with a key operation or an alarm occurrence. By default, the backlight saver is disabled. For the setting procedure, see section 2.7.

1.4 Data Storage Function

This section explains the types of data that the FX can record and how to store them.

Data Types

The FX can record the following types of data.

Data Type	Description
Display data	<ul style="list-style-type: none"> Waveform data displayed on the trend display. The measured data is recorded as a specified sampling interval. The sampling interval is specified using the trend interval. The minimum and maximum values among the measured data within the sampling interval are saved. A header string (common to other files) can be written in the file. The display data contains alarm and message information. Data format: Binary (Undisclosed)
Event data	<ul style="list-style-type: none"> Measured data that is recorded at a specified sampling interval. There are two modes. One mode starts recording when a trigger event occurs. The other mode records at all times. A header string (common to other files) can be written in the file. The event data contains alarm and message information. Data format: Binary (Undisclosed)
Manual sampled data	<ul style="list-style-type: none"> Instantaneous value of the measured data when a manual sample operation is executed. A header string (common to other files) can be written in the file. Data format: Text
Report Data (/M1, /PM1, /PWR1, and /PWR5 options)	<ul style="list-style-type: none"> Hourly, daily, weekly, and monthly report data. Report data is created at an interval that is determined by the report type (one hour for hourly reports, one day for daily reports, and so on). A header string (common to other files) can be written in the file. Data format: Text
Snapshot data (screen image data)	<ul style="list-style-type: none"> FX screen image data. The data can be saved to a CF card/SD card. Data format: PNG
Setup data	<ul style="list-style-type: none"> The setup data of the FX. Data format: Binary (Undisclosed)

• Display data and event data

Display data can be likened to the conventional recording on the chart sheet and are useful for long-term recording. Event data is useful when you wish to record the measured data in detail.

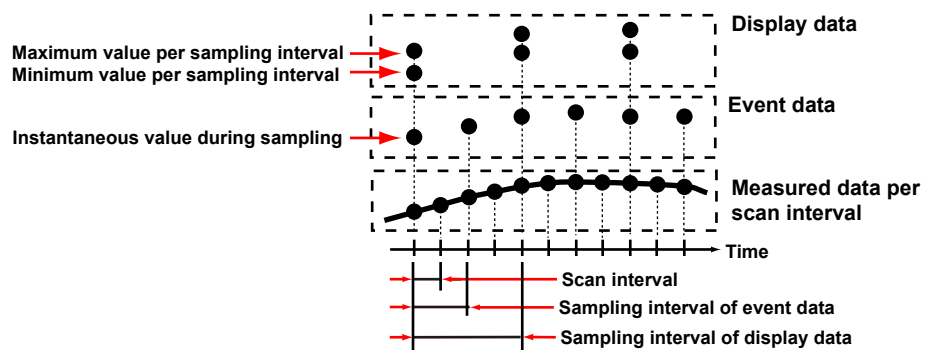

Flow of Data Recording and Storage

Measured data is recorded once to the internal memory and then saved to the external storage medium.

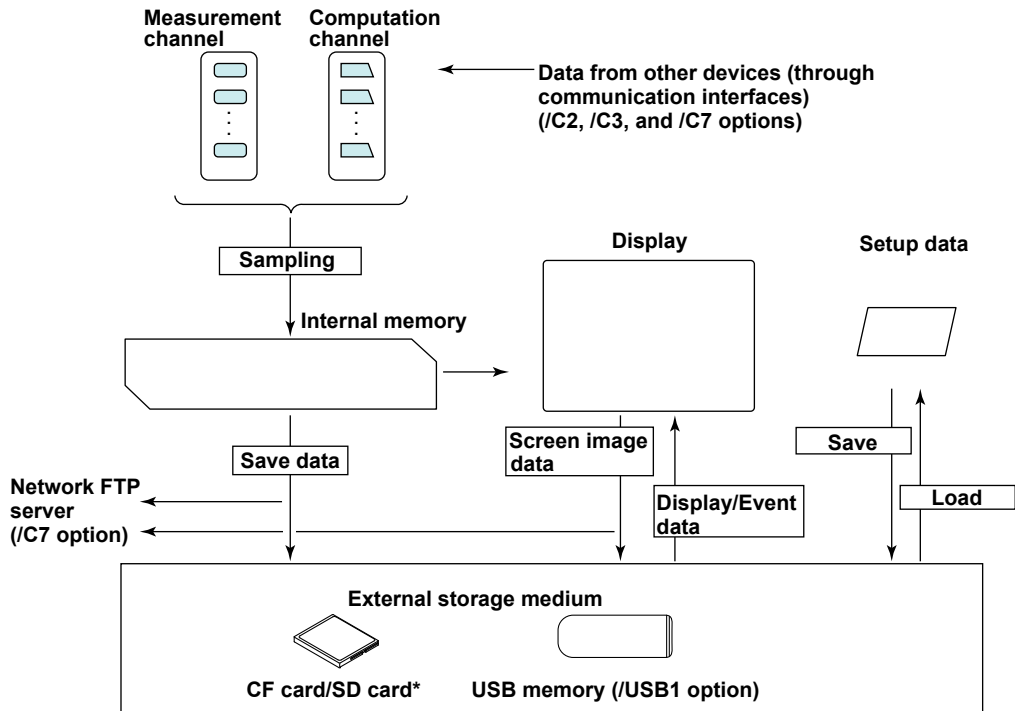

* This cannot be performed on models that do not have a CF card/SD card slot (suffix code -0).

Internal Memory

Display data and event data are held in files in the internal memory. This data is also saved as files to an external storage medium.

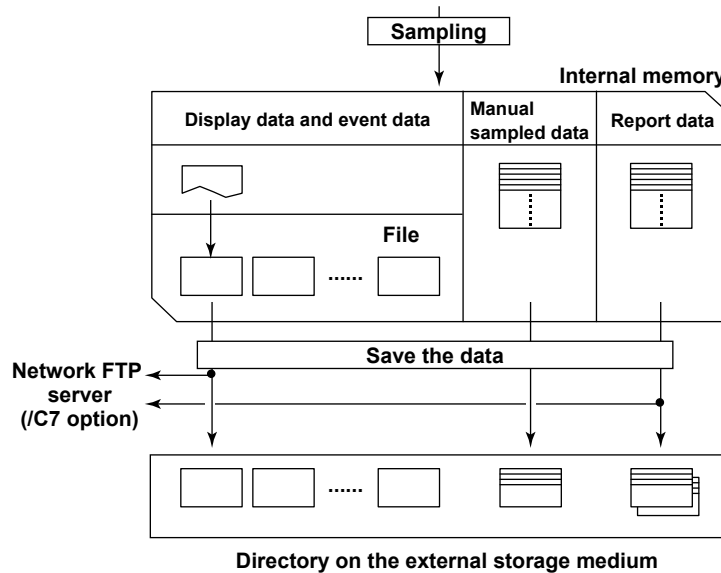

Recording Method of Display Data and Event Data

For the setting procedure, see section 6.1. For operating instructions, see section 6.4.

• Types of Data to Be Acquired

Select display data only, display data and event data, or event data only.

Deciding the Data to Be Recorded

Record the data that suits your application. Refer to the following examples.

Example 1: Continuously record the waveform data as with the conventional chart recorder.

Record the display data.

Example 2: Record waveform data under normal conditions but record details around the point of alarm occurrence when alarms occur.

Continuously record display data and record event data when alarms occur.

Example 3: Only record the most-detailed data at all times.

Record event data by specifying the sampling interval.

Example 4: No need to continuously record data. Record data only when alarms occur.

Record event data only when alarms occur.

• Internal Memory

The recorded measured data is divided at a specific time interval and saved to files.

If the internal memory is full or if the number of display data files and event data files exceeds 400, files are overwritten from the oldest file.

• Recording Conditions of Display Data

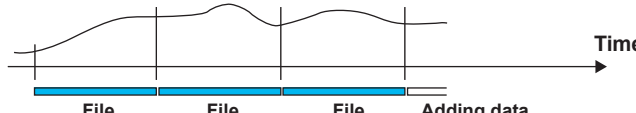
Item	Description
Source channels	Select from measurement channels and computation channels.
Sampling interval	Specify the sampling interval with the trend interval (see the table below). You cannot specify a sampling interval that is faster than the scan interval.
File creation	Files are created at the specified file save interval.  <ul style="list-style-type: none"> Files are also created in the following cases. <ul style="list-style-type: none"> When a file is created manually. When the memory sampling is stopped. When file creation is executed with the event action function. After recovering from a power failure.
Memory start/stop	Press the START key to start recording (memory start) and the STOP key to stop the recording (memory stop).

Trend interval and the sampling interval of display data

Trend interval¹	15 s²	30 s	1 min	2 min	5 min
Sample rate	500 ms	1 s	2 s	4 s	10 s
Trend interval	10 min	15 min	20 min	30 min	1 h
Sample rate	20 s	30 s	40 s	1 min	2 min
Trend interval	2 h	4 h	10 h		
Sample rate	4 min	8 min	20 min		

1 You cannot set a trend interval that corresponds to a sampling interval that is faster than the scan interval.

2 Selectable on the FX1002 and FX1004

• **Recording Conditions of Event Data**

Item	Description
Source channels	Same as the display data.
Sampling interval	Choices are available in the range of 125 ms to 10 min. However, you cannot specify an interval that is faster than the scan interval.
File creation	A file is created when the specified data length is reached. Files are also created in the following cases. <ul style="list-style-type: none"> • When a file is created manually. • When the memory sampling is stopped. • When file creation is executed with the event action function. • After recovering from a power failure.

Mode
 The available modes are **Free** (continuously record), **Single**, and **Repeat**. The recording operation varies depending on the mode as follows:
Free
 Press the START key to start recording (memory start) and the STOP key to stop the recording (memory stop) .

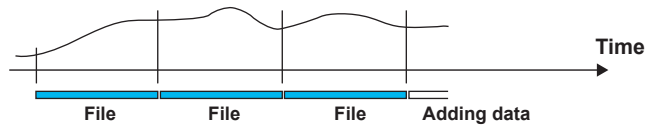

Single

Pressing the START key places the FX in the trigger-wait state. After a trigger event occurs, the FX will record data for the set time (data length). From this point, the FX does not record even if the trigger condition is met.

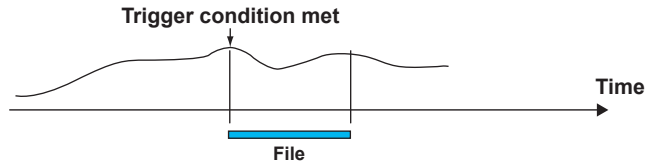

Repeat

Pressing the START key places the FX in the trigger-wait state. After a trigger event occurs, the FX will record data for the set time (data length). The FX enters the trigger-wait state again and keeps recording the data for a specified time (data length) each time the trigger condition is met. To stop recording event data, press STOP.

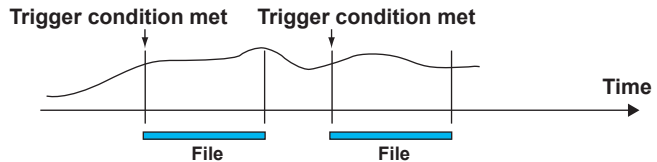

Pretrigger of Event Data

The pretrigger can be specified in trigger mode. This function is used to save the data before the point where the trigger condition is met as event data. This function is convenient when you wish to record the data before the occurrence of a certain event such as when an alarm occurs. Specify the pretrigger as a percentage (0, 5, 25, 50, 75, 95, or 100%) of the recording time (data length) of the event data. If set to 0%, the data after the trigger condition is met is recorded.

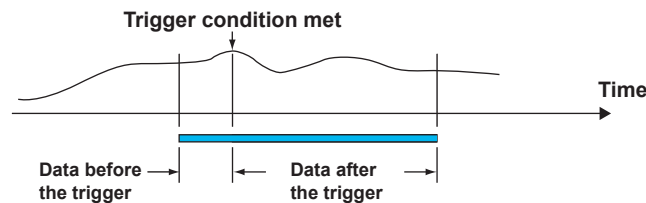

Trigger for Starting the Event Data Recording

When set to trigger mode, you can set various conditions for starting the recording. Example: Key operation, alarm occurrence, specific time, or remote control

- **Creating Files through Key Operation**

Files can be created using keys.

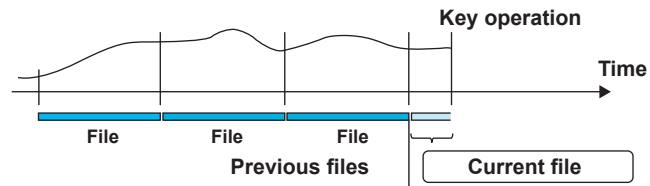

For operating instructions, see “Creating a Display Data File or an Event Data File” in section 6.4.

Manual Sampled Data

Manual sampled data is recorded to the internal memory. When the number of manual sampled data exceeds 400, the data is overwritten from the oldest data.

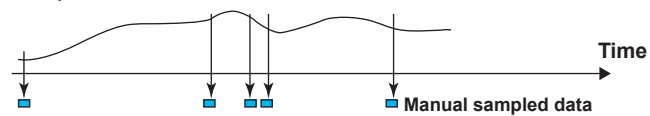

Report Data

Report data is recorded to the internal memory. When the number of report data exceeds 100, the data is overwritten from the oldest data.

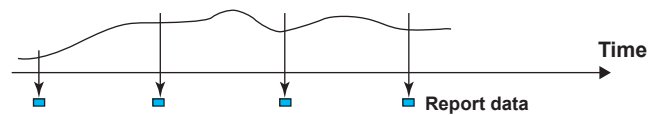

Saving Data to the External Storage Medium

You can only use this feature on FXs that have a CF card slot/SD card slot or USB interface (/USB1 option).

For the setting procedure, see section 6.2. For operating instructions, see section 6.4.

- **Type of External Storage Medium**

- CF card
- SD card (SD/SDHC)*
- USB flash memory (/USB1 option)
 - * The write protected SD card cannot be used on this product.

- **Auto Save**

Have the CF card/SD card inserted in the slot at all times. The data in the internal memory is automatically saved to the CF card/SD card.

Auto Save Timing

Data Type	Description
Display data	The file is saved when the file is created.

Event data	Same as the display data.
------------	---------------------------

Manual sampled data	The first time manual sample is executed, a manual sampled data file is created on the CF card/SD card. The data is appended to this file for each subsequent manual sample operation. A new file is created after manual sampled data has been stored 100 times. For operating instructions, see section 6.5.
---------------------	--

Report data	<p>The first time report data is generated, a report data file is created on the CF card/SD card and report data is stored. The report data is appended to this file every time of report.</p> <p>Dividing of the report files</p> <p>The appending of the report data to the file is stopped at a specified time, and subsequent reports are saved to a new file. The file is divided in the unit shown in the table below. Also, when recording is stopped (memory stop), all report files are divided.</p> <p>For the setting procedure, see section 9.5.</p>
-------------	---

Report Type	Report File	
	File for Each Type	Combine
Hourly report	<input type="checkbox"/> hourly reports of a day	<input type="checkbox"/> hourly reports of a day
Daily report	<input type="checkbox"/> daily reports for a month	<input type="checkbox"/> daily reports for a month
Hourly and daily reports	<input type="checkbox"/> a file for each daily report <input type="checkbox"/> hourly reports for a day	<input type="checkbox"/> hourly reports for a day and a daily report
daily and weekly reports	<input type="checkbox"/> a file for each weekly report <input type="checkbox"/> daily reports for a week	<input type="checkbox"/> daily reports for a week and a weekly report
Daily and monthly reports	<input type="checkbox"/> a file for each monthly report <input type="checkbox"/> daily reports for a month	<input type="checkbox"/> daily reports for a month and a monthly report

Save Destination

CF card/SD card.

Data Save Destination Directory

You can set the data save destination directory name (DATA0 by default). The specified directory is created on the CF card/SD card, and the data is saved in the directory.

Save Operation (If Media FIFO Is Disabled)

The data in the internal memory can be saved only if there is sufficient free space on the CF card/SD card. Replace the CF card/SD card and save the data before the data in the internal memory is overwritten.

Save Operation (Always retain most recent data file/media FIFO)

When saving the data files automatically, you can save the data so that the most recent data files are constantly retained in the CF card/SD card. With this method, you can use the FX continuously, without changing the CF card/SD card.

- **Operation**

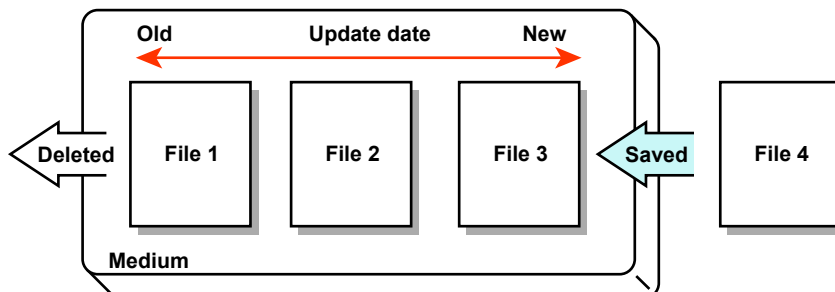

If not enough free space is available when saving a new data file to the CF card/SD card, files are deleted in order from the oldest data update date/time to save the new file. This operation is referred to as FIFO (First In First Out).

- The FIFO operation is carried out only when saving the following files automatically. It is not carried out when saving files to the save destination directory using another method.
 - Display data files, event data files, report data files, manual sample data files, and snapshot data files.
 - Files that are deleted
 - All the files in the save destination directory are applicable to be deleted. However, the following files are excluded. Hidden files, read-only files, files in the subdirectory within the save destination directory.
 - The most recent 1000 files are retained. If the number of files in the save destination directory exceeds 1000, the number of files is held at 1000 by deleting old files even if there is enough free space.
 - If there are more than 1000 files already in the save destination directory, one or more files are always deleted before saving the new file. The number of files is not kept within 1000 in this case.
- **Creating a Display Data File or an Event Data File**

The save destination is the CF card/SD card. You can create a file when display data is being recorded or when event data is being recorded in Free mode. Unsaved measured data is saved to the CF card/SD card.

For operating instructions, see section 6.4.
 - **Manual Save (Collectively Storing Unsaved Data)**

Unsaved data in the internal memory is stored in unit of files to the external storage medium when an external storage medium is inserted and a given operation is carried out.

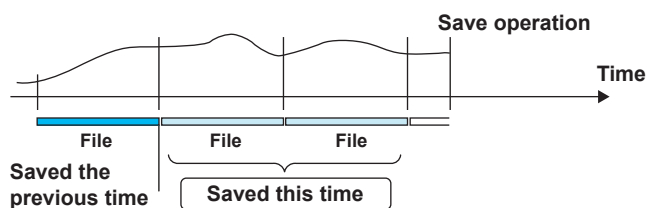

When using manual save, it is important that you save the data in the internal memory to the external storage medium before the data is overwritten. Determine the usage condition of the internal memory and save the data to the external storage medium at appropriate times.

1.4 Data Storage Function

Save Destination

You can select a CF card/SD card or USB flash memory (/USB1 option).

Data Save Destination Directory

You can set the data save destination directory name (DATA0 by default).

- **File Name**

The FX can name measured data files that are automatically saved to the internal memory in one of the following three ways.

Structure	Description	
Date	Display data Event data Manual sampled data Snapshot data	<div style="border: 1px solid black; padding: 2px;"> Serial Specified string Date . Extension </div> Example: 000123_AAAAAAAAAA110928_174633.DAD
	Report data	<div style="border: 1px solid black; padding: 2px;"> Serial Specified string Date Type . Extension </div> Example: 000123_AAAAAAAAAA11050928_174633HD.DAR
Serial	Display data Event data Manual sampled data Snapshot data	<div style="border: 1px solid black; padding: 2px;"> Serial Specified string . Extension </div> Example: 000123_AAAAAAAAAA.DAD
	Report data	<div style="border: 1px solid black; padding: 2px;"> Serial Specified string Type . Extension </div> Example: 000123_AAAAAAAAAAHD.DAR
Batch name	Display data Event data	<div style="border: 1px solid black; padding: 2px;"> Serial Batch name . Extension </div> Example: 000123_BBBBBBBBBBBBBBBBBBBBBB.DAD
	Report data	<div style="border: 1px solid black; padding: 2px;"> Serial Date Type . Extension </div> Example: 000123_110928_174633HD.DAR
	Manual sampled data Snapshot data	<div style="border: 1px solid black; padding: 2px;"> Serial Date . Extension </div> Example: 000123_110928_174633.DAM

Item	Description	
Serial	Construction: 6-digit number + 1-character delimiter	
	6-digit number	A sequence number in the order of occurrence. The number ranges from 000001 to 999999. If the number reaches 999999, it returns to 000000.
	1-character delimiter	Starts with '_' and takes on the following values: A to Z and 0 to 9. If a file with the same name exists in the specified directory, the file is saved by changing the delimiter to prevent overwriting. Example: If a file named "000123_AAAAAAAAAA.DAD" already exists, the file is saved to the name "000123AAAAAAAAAAAA.DAD."
Date	YYMMDD_hhmmss	YY: Year (lower two digits), MM: Month, DD: Day hh: Hour, mm: Minute, ss: Second
Specified string	AAAAAAAAAAAA	Up to 16 alphanumeric characters can be used
Batch name	BBBBBBBBBBB . . . B	Up to 40 alphanumeric characters can be used
Type	H_, D_, W_, M_, HD, DW, DM	Report data type H_: Hourly, D_: Daily, W_: Weekly, M_: Monthly, HD: Hourly and daily, DW: Daily and weekly, DM: Daily and monthly
Extension	Display data: DAD Event data: DAE	Report data: DAR Snapshot data: PNG Manual sampled data: DAM

- **Saving Data through Key Operation**

You can carry out the following data save operations regardless of whether auto save or manual save is used.

For the operating procedure, see section 4.8.

Data Storage	Description
All save	Collectively saves all the data in the internal memory.
Selective save	Saves the specified display data or event data file.
Manual sampled data save	Collectively saves all the manual sampled data in the internal memory.
Report data save	Collectively saves all the report data in the internal memory.

Save Destination

You can select a CF card/SD card or USB flash memory (/USB1 option).

Data Save Destination Directory

Creates a directory with the name of the data save destination directory name with the date/time added and saves the data.

Directory name: "Specified string"_YYMMDD_HHMMSS

Example: If a file is saved on September 30, 2011 at 17:06:42, the file will be saved to a directory with the name DATA0_110930_170642. "DATA0" is the specified string.

Note

The number of directories that you can create on the external storage medium varies depending on the length of the directory names. If the length of the "specified string" is 5 characters, approximately 170 directories can be created. If it is 20 characters, approximately 120 directories can be created. An error occurs, if you try to create directories exceeding this limit.

Other Types of Data That Can Be Stored

- **Setup Data**

You can save the FX setup data to a CF card/SD card or to USB flash memory (/USB1 option). The setup data is saved to the root directory.

Name of the setup data file	Specified . PDL Example: ABCD10005.PDL
------------------------------------	---

For the operating procedure, see section 6.9.

- **Snapshot Data**

The FX display is saved to the CF card/SD card as a PNG file. It is saved in the same directory as display and event data. For the file name, see the previous page.

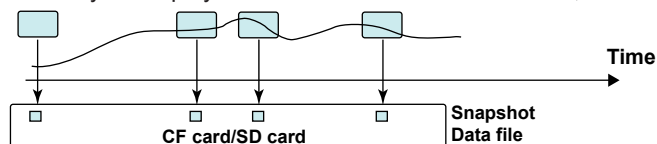

For the operating procedure, see section 6.9.

Saving Data through an Ethernet Network (/C7 option)

Using the FTP client function, display data, event data, report data (/M1, /PM1, /PWR1, or /PWR5 option), and screen image data (snapshot data) can be automatically transferred and saved to an FTP server through an Ethernet network. You can also use the FX as an FTP server. You can access the FX from a PC and retrieve and store data files from both internal and external memory.

See the *Communication Interface User's Manual*, IM 04L21B01-17EN.

1.5 Batch Function

You can add the batch information listed below to display data files and event data files. You can use batch information to manage display data files and event data files. For the setting and operating procedure, see section 6.3.

Batch Information

- **Batch Number and Lot Number**

Display data files and event data files can be identified by their “batch number-lot number” (hereinafter referred to as batch name). The lot number does not have to be specified.

- Batch number (up to 32 characters).
- Lot number (up to 8 digits)

- **Automatic Increment of the Lot Number**

The lot number can be automatically incremented when the memory sampling is stopped.

- **Text Field**

You can enter text fields into a file. Eight text fields are available. Each text field consists of the following:

- Field title (up to 20 characters)
- Field string (up to 30 characters)

You can use the keys to display text fields on the FX screen.

- **Batch Comment**

Three arbitrary comments can be entered in a file. Each comment can be entered only once while memory sampling is in progress.

- Comment 1, Comment 2, and Comment 3 (up to 50 characters each)

Using the Batch Function

See the figure below. For example, enter the operator and administrator in the text field.

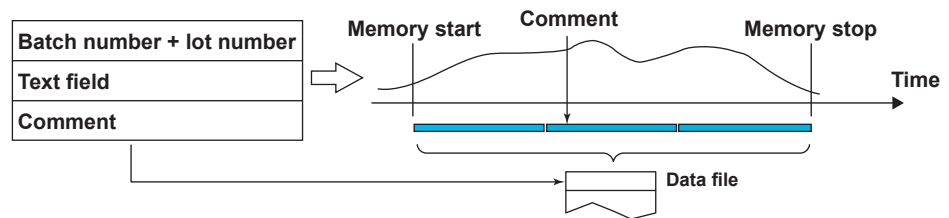

1.6 Event Action and Remote Control Functions (/R1 and /PM1 Options)

A specified action is carried out when an event occurs. This function is called *event action*. The remote control function (/R1 and /PM1 options) allows you to specify actions to be performed when the terminal receives a contact input or an open collector signal. The remote control function is configured using the event action function. For the setting procedure, see section 7.1.

Events

- **Events**

Select from the following events.

Event	Level/Edge ¹	Description
Remote	Level/Edge	ON/OFF of the remote control input.
Output relay	Level/Edge	Activated/Deactivated condition of the alarm output relay.
Internal switch	Level/Edge	The value, 0 (off) or 1 (on), of the internal switch.
Timer	Edge	Timer timeout.
Match time timer	Edge	When the time matches.
Alarm	Level/Edge	The state in which any alarm is occurring and the state in which no alarm is occurring.
USER key	Edge	The operation of pressing the USER key.

¹ For a description of level and edge, see "Miscellaneous" in this section.

- **Output Relay, Internal Switch, Alarm**

The output relay, internal switch, and alarm have two states, state A and state B, which are explained in the table below.

Event	State A	State B
Output relay	Deactivated	Activated
Internal switch	OFF	ON
Alarm	No alarms	At least one alarm

When Edge Is Selected

An event occurs when state A changes to state B.

When Level Is Selected

There are action states that correspond to state A and state B.

See "Miscellaneous" and "Level and Edge" in this section.

1.6 Event Action and Remote Control Functions (/R1 and /PM1 Options)

- **Timers**

Four timers are available. The timers are also used with the TLOG computation (/M1, /PM1, /PWR1, and /PWR5 options).

Timer Type

Absolute timer

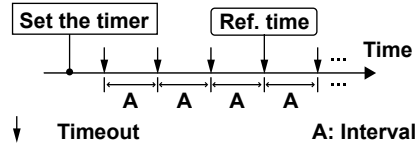

Relative timer

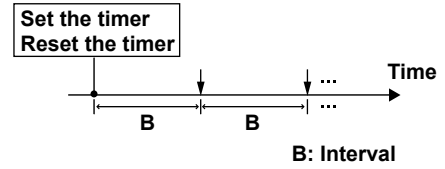

- **Absolute Time Mode**

The timer expires at the times determined by the reference time and the interval. The reference time is set on the hour (00 to 23).

Example: Reference time: 00:00
Interval: 10 min

The timer expires at 0 hour, 0 hour 10 min, 0 hour 20 min, ... 23 hour 40 min, and 23 hour 50 min. For example, if the timer is set at 9 hour 36 min, the timer expires at 09 hour 40 min, 09 hour 50 min, 10 hour, and so on.

- **Relative Time Mode**

The timer is started when the timer is set, and the timer expires every specified interval. In this mode, the timer stops when a power failure occurs.

Example: Interval: 00:15
The timer expires every 15 minutes.

- **Match Time**

You can set the time matching conditions for the four match time timers. Specify the date/time using the method described below. For each condition, you can select whether to use the condition once or continuously.

Specified Date/Time	Description
Y hour of the X day	The condition is met once a month.
Y hour of the X day of the week	The condition is met once a week.
Y hour	The condition is met once a day.

Action

• Actions

Select from the following actions.

Action	Level/Edge ¹	Description
Memory start/stop	Level	Starts/stops memory sampling.
Memory start	Edge	Starts the memory sampling.
Memory stop	Edge	Stops the memory sampling.
Event trigger	Edge	Applies a trigger for starting the event data recording. This is valid when recording event data in trigger mode. See the next page.
Alarm acknowledge	Edge	Releases the alarm output. This is valid when the use of the alarm ACK operation is enabled.
Computation start/stop ²	Level	It is used to start/stop the computation.
Computation start ²	Edge	Starts the computation.
Computation stop ²	Edge	Stops the computation.
Computation reset ²	Edge	Resets the computed values on all computation channels.
Save display data	Edge	The display data being recorded is saved to the internal memory as a file. This is the same function as the data save operation using the FUNC key.
Save event data	Edge	The event data being recorded is saved to the internal memory as a file. This is the same function as the data save operation using the FUNC key.
Message	Edge	Writes a message. This action can be executed while memory sampling is in progress.
Snapshot	Edge	Saves the screen image data.
Switch the display rate	Level	Toggles between the trend interval and the secondary trend interval. This action is valid when the FX is configured to use trend interval switching.
Manual sample	Edge	Executes manual sampling.
Reset the relative timer	Edge	Resets the relative timer. The timer restarts from that point. See the next page.
Switch the display group	Edge	Switches the display group when the trend, digital, or bar graph is displayed.
Flag ²	Level	The flag is zero for normal conditions and 1 when an event occurs. When the event is an edge operation, the value alternates between 0 and 1 whenever an event occurs. The flag can be written in a calculation expression of a computation channel.
Load the setup	Edge	Loads the setup data file in the root directory of the CF card/SD card into the FX and updates the FX settings. See the next page.
Adjust the time	Edge	Synchronizes the time to the nearest hour. See the next page.

¹ For a description of level and edge, see "Miscellaneous" in this section.

² This is an option.

Event Trigger Operation

When the event is set to output relay, internal switch, or alarm
 If the output relay is activated, the internal switch is 1, or the alarm is occurring during memory sampling, the event trigger is always activated. However, the number of times the trigger is activated depends on the event data mode (single or repeat).

Resetting the Relative Timer

If the event is set to output relay, internal switch, match time timer, or alarm, the resetting of the timer is not considered a timeout. (The action is not executed even if the timer is used as an event.)

Loading the Setup

Can be specified as an action only when the event is set to remote control input.
 Loads the setup data file, LOAD1.PDL, LOAD2.PDL, or LOAD3.PDL, in the root directory of the CF card/SD card into the FX and updates the FX settings.
 You must create a setup file and save it to the CF card/SD card in advance.

Time Adjustment

Time adjustment can be specified as an action only when the event is set to remote control input. The internal clock of the FX is adjusted to the nearest hour through remote control input.

• **Operation When Memory Sampling Is Stopped**

Difference from the Nearest Hour	Operation
00 min 00 s to 01 min to 59 s	Truncates the minutes and seconds. Example: 10 hours 01 min 50 s becomes 10 hours 00 min 00 s.
02 min 00 s to 57 min to 59 s	The time is not changed.
58 min 00 s to 59 min to 59 s	Rounds up the minutes and seconds. Example: 10 hours 59 min 50 s becomes 11 hours 00 min 00 s.

• **Operation during Memory Sampling (see section 1.10)**

- If the time difference T_d between the time of the event and the nearest “on the hour” hour is less than 2 minutes, the following operation is performed depending on different conditions.
- If T_d is less than or equal to the preset time difference, the clock is adjusted gradually.
 - If T_d is greater than the preset time difference, the clock is adjusted immediately.
- If T_d is greater than or equal to 2 minutes, the clock is not adjusted.

Miscellaneous

• **Limitations on the Combinations of Events and Actions**

The combinations that are checked in the table below can be used.

Event \ Action	Remote	Output Relay	Internal Switch	Timer	Match Time Timer	Alarm	User Key
Alarm ACK	✓			✓	✓		✓
Reset the relative timer	✓	✓	✓		✓	✓	✓
Load the settings	✓						
Adjust the time	✓						
Other actions	✓	✓	✓	✓	✓	✓	✓

• **Level and Edge**

The combinations of events and actions are summarized in the figure below.

Type	Operation	
Event		
Action		

Event Action Example

The following is an example for when the event is Internal switch (Level or Edge) and the action is Memory start/stop (Level) or Manual sample (Edge).

Event Action	Operation	
	Level	Edge
Event (internal switch)		
Action		

Level and Edge of the Remote Control Input Signal



For contact inputs, the remote signal rises when the contact switches from open to closed and falls when the contact switches from closed to open. For open collector signals, the remote signal rises when the collector signal (voltage level of the remote terminal) goes from high to low and falls when the collector signal goes low to high.

1.7 Security Function

This section will explain the FX security functions.

Key Lock Function

Key lock is a function that prohibits key operations. You enter a password to release the key lock.

For the setting procedure, see section 8.1.

Key Lock Items	Description
Keys	The following keys can be locked independently. START key, STOP key, MENU key, USER key, DISP/ENTER key (prohibits switching the operation screen).
Access to the storage medium ¹	Prohibits all operations listed below. <ul style="list-style-type: none">Manually save the dataLoad the display data and event data filesSave/Load setup data filesListing of files stored on the external storage mediumDeleting files stored on the external storage mediumFormatting external storage media
Loading setup data ²	Prevents external storage medium access for the purpose of loading setup files.
Function operation	The following FUNC key operations can be locked independently. <ul style="list-style-type: none">[Alarm ACK][Message], [Free message], [Batch], [Add Message], [Add Free Message] [Text field][Math start],³ [Math stop],³ [Math reset],³ [Math ACK]³[Save display], [Save event], [Manual sample], [Trigger], [Snap shot], [Timer reset], [Save stop],¹[E-Mail start],³ [E-Mail stop],³ [E-Mail test],³ [FTP test],³ operations to [Request] or [Release] network information³[SNTP],³ time setting (operation in setting mode)[Standard display], [Second speed], [Normal speed]

1 On FXs that have a CF card slot/SD card slot or USB interface (/USB1 option)

2 On FXs that have a CF card slot/SD card slot

3 Optional

Login Function

With the login function, only registered users can operate the FX. Access from communication functions (/C7 option) can also be limited to users registered here. For the setting and operating procedure, see sections 8.2 and 8.3 respectively.

• Login and Logout

You enter your user name and password to log into the FX in the following cases.

FX Access Method	Login Required
Keys	<ul style="list-style-type: none"> When the power is turned ON When logging in after exiting the basic setting mode When logging in after logging out
Communication (/C7 option)	When accessing the setting/measurement server, FTP server, maintenance/test server, or Web server.

Auto Logout (When Logged in Using Keys)

When logged in using keys, you are automatically logged out when there is no key operation for a specified time. If you are automatically logged out from the setting mode, the setting changes are cancelled. You are not automatically logged out during basic setting mode.

Operations That Can Be Carried Out When Logged Out

When logged out, you can switch the operation screen using the DISP/ENTER key and arrow keys.

• User Levels

A user can be an “administrator” or a “user.”

Administrator

Administrators can perform all operations on the FX. At least one administrator must be registered to use the login function.

Item	Description
Number of users that can be registered	5
Range of operations	All operations.
Login method	Select key operation, via communication, or Web server login.
ID information	User name and password

User

Item	Description														
Number of users that can be registered	30														
Range of operations	<table border="1"> <thead> <tr> <th colspan="2">Key operations</th> <th>Limitation</th> </tr> </thead> <tbody> <tr> <td colspan="2">Basic setting mode</td> <td>Not allowed</td> </tr> <tr> <td rowspan="2">Setting mode</td> <td>Menu customizes</td> <td>Not allowed</td> </tr> <tr> <td>Other</td> <td>Specified with user privileges</td> </tr> <tr> <td>Operation mode</td> <td>Key operations</td> <td>Specified with user privileges</td> </tr> </tbody> </table> <ul style="list-style-type: none"> User privileges You can set operation privileges for each user. The privileges are the same as with the key lock function. For details about operations via communication, see the <i>Communication Interface User's Manual</i>, IM 04L21B01-17EN. 	Key operations		Limitation	Basic setting mode		Not allowed	Setting mode	Menu customizes	Not allowed	Other	Specified with user privileges	Operation mode	Key operations	Specified with user privileges
Key operations		Limitation													
Basic setting mode		Not allowed													
Setting mode	Menu customizes	Not allowed													
	Other	Specified with user privileges													
Operation mode	Key operations	Specified with user privileges													
Login method	Select key operation, via communication, or Web server login.														
ID information	User name and password														

1.8 Computation and Report Functions (/M1, /PM1, /PWR1, and /PWR5 Options)

Computation Function

Equations can be defined on special computation channels by using measured data, power data, or computed data as variables. The computation channel data can be displayed or saved.

For the setting procedure, see section 9.1.

- **Channels Dedicated to Computations**

Model	Number of Channels	Channel Numbers
FX1002 and FX1004	12	101 to 112
FX1006, FX1008, FX1010, and FX1012	24	101 to 124

- **Computation Types**

In the table below, [001] represents the measured value of channel 001.

Type	Example	Description of the Example
Four arithmetic operation	001+002	Determines the sum of [001] and [002].
	001-002	Determines the difference between [001] and [002].
	001*002	Determines the product of [001] and [002].
	001/002	Divides [001] by [002].
Power	001**002	Determines [001] to the power of [002]. $y = X^n$
Square root	SQR(001)	Determines the square root of [001].
Absolute value	ABS(001)	Determines the absolute value of [001].
Common logarithm	LOG(001)	Determines the common logarithm of [001]. $y = \log_{10}x$
Natural logarithm	LN(001)	Determines the natural logarithm of [001]. $y = \ln x$
Exponent	EXP(001)	Determines e to the power of [001]. $y = e^x$
Relational computation	001.LT.002	The result is 1 when [001] is less than [002] or 0 otherwise.
	001.LE.002	The result is 1 when [001] is less than equal to [002] or 0 otherwise.
	001.GT.002	The result is 1 when [001] is greater than [002] or 0 otherwise.
	001.GE.002	The result is 1 when [001] is greater than equal to [002] or 0 otherwise.
	001.EQ.002	The result is 1 when [001] is equal to [002] or 0 otherwise.
	001.NE.002	The result is 1 when [001] is not equal to [002] or 0 otherwise.
Logical computation	001AND002	The result is 1 when [001] and [002] are nonzero or 0 otherwise.
	001OR002	The result is 1 when [001] or [002] or both are nonzero or 0 otherwise.
	001XOR002	The result is 0 when [001] and [002] are nonzero or 1 otherwise.
	NOT001	The result is 1 when [001] is zero or 0 otherwise.
TLOG computation*	TLOG.SUM(001)	Determines the sum of [001].
	TLOG.MAX(001)	Determines the maximum value of [001].
	TLOG.MIN(001)	Determines the minimum value of [001].
	TLOG.AVE(001)	Determines the average value of [001].
	TLOG.P-P(001)	Determines the difference between the maximum value and minimum value of [001].

* See "Usage of TLOG Computations" in this section.

1.8 Computation and Report Functions (/M1, /PM1, /PWR1, and /PWR5 options)

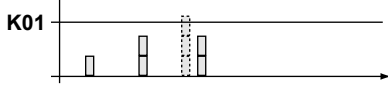
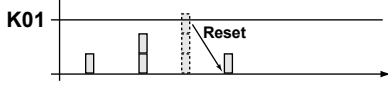
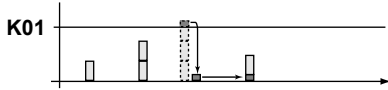
Type	Example	Description of the Example
CLOG computation	CLOG.SUM(001.002.003)	Determines the sum of [001], [002], and [003].
	CLOG.MAX(001.002.003)	Determines the maximum value among [001], [002], and [003].
	CLOG.MIN(001.002.003)	Determines the minimum value among [001], [002], and [003].
	CLOG.AVE(001.002.003)	Determines the average value of [001], [002], and [003].
	CLOG.P-P(001.002.003)	Determines the difference between the maximum value and the minimum value among [001], [002], and [003].
Special computation	PRE(001)	Determines the previous value of [001].
	HOLD(101.GT.K01):TLOG.SUM(001)	Under normal conditions, TLOG.SUM(001) is carried out to derive the computed value. When [101] exceeds K01, the previous computed value is held.
		
Description	HOLD(a):b	When a is zero, b is carried out to derive the computed value. Otherwise, the previous computed value is held.
	RESET(101.GT.K01):TLOG.SUM(001)	Under normal conditions, TLOG.SUM(001) is carried out to derive the computed value. When [101] exceeds K01, the previous computed value is reset, and TLOG.SUM(001) is carried out.
		
Description	RESET(a):b	When a is zero, b is carried out to derive the computed value. Otherwise, the previous computed value is reset, and b is carried out to derive the computed value.
	CARRY(K01):TLOG.SUM(001)	Under normal conditions, TLOG.SUM(001) is carried out to derive the computed value. When the computed value is greater than or equal to K01, the computed result is the excess (computed value - K01).
		
Description	CARRY(a):b	Only TLOG.SUM can be specified for b. If the computed value X of b is less than a, the computed result is X. If X is greater than or equal to a, the computed result is the excess (X - a).
Conditional equation	[001.GT.K01?001:001+002]	When [001] is greater than K01, the computed value is set to the value of [001]. Otherwise, the computed value is set to the value of [001] + [002].
Description	[a?b:c]	If the computed result of a is nonzero, b is carried out. Otherwise, c is carried out.

1.8 Computation and Report Functions (/M1, /PM1, /PWR1, and /PWR5 options)

- **Data That Can Be Used in Equations**

The data listed below can be used.

Data	Notation	Description
Measurement channel data	001, etc.	Specify the computed data using a channel number.
Computation Channel data ¹	101, etc.	Specify the computed data using a channel number.
Constant	K01 to K60	A value.
Communication input data	C01 to C24	Data set through communications.
Status of the remote control input ¹	D01 to D08 ²	The value is 1 when the remote control input is ON or 0 when it is OFF.
Pulse input ¹	P01 to P08 ²	Counts the number of pulses per scan interval.
	Q01 to Q08 ²	Counts the number of pulses per second.
Internal switch status	S01 to S30	1 or 0.
Alarm output relay status ¹	I01 to I06 and I11 to I16	The value is 1 when activated or 0 when deactivated.
Flag ¹	F01 to F08	Use the event action function to set the flag (for details, see section 1.6).
Power data ¹	WAT, etc.	For details, see section 3.12.

¹ An option.

² Values such as 01 are terminal numbers.

Only the data that are checked in the table below can be used in TLOG, CLOG, and PRE.

Comp	Data Meas. Channel	Comp. Channel	Constant	Comm. Input	Remote	Pulse	Internal Switch	Relay	Flag	Power
TLOG	✓	✓	✓	✓	✓	✓	✓	✓	✓	✓
CLOG	✓	✓	✓	✓	✓	✓	✓	✓	✓	✓
PRE	✓	✓	✓	✓	✓	✓	✓	✓	✓	✓
Other computations	✓	✓	✓	✓	✓	✓	✓	✓	✓	✓

Example: TLOG.SUM(S01), CLOG.AVE(001.002.K01), and PRE(S01) are not allowed.

- **Processing Order of Computation**

Computation functions are performed every scan interval, starting with the smallest computation channel number.

Example: If you specify $102 = 101 + 103$, the value of the previous scan interval is used for the 103 value.

- **Handing of the Unit in Computations**

In computations, measured values are handled as values without units. For example, if the measured data from channel 001 is 20 mV and the measured data from channel 002 is 20 V, the computed result of $001 + 002$ is 40.

- **Displaying the Computed Data**

The computed data is displayed by setting a measurement span for each computation channel. Computation channels can be displayed on various operation screens in the same fashion as the measurement channels.

For the setting procedure, see section 9.3.

- **Alarm**

Up to 4 alarms can be assigned to each computation channel. The alarm types are high limit alarm (H), low limit alarm (L), delay high limit alarm (T), and delay low limit alarm (t).

- **Saving Computed Data**

As with the measured data, the computed data can be saved to display data, event data, manual sampled data, and report data.

1.8 Computation and Report Functions (/M1, /PM1, /PWR1, and /PWR5 options)

• Computation Data Dropout

A computation data dropout occurs if the computation is not completed within the scan interval. For the operating procedure, see section 9.4.

- The computation icon in the status display section turns yellow.
- When a computation data dropout occurs, the computed data of the scan interval in which the dropout occurred is set to the data immediately before the dropout.
- If computation data dropout occurs frequently, lessen the load on the CPU by reducing the number of computation channels or setting a longer scan interval.

• Numeric Display and Recording

The range of displayed values of computed data is from -9999999 to 99999999 excluding the decimal point. The decimal place corresponds to the decimal place of the lower limit span of the computation channel. On the numeric display, values are displayed if the computed result is within the above range regardless of the upper and lower limits of span. The following table indicates special displays.

Display/Recording	Computed Data Status
+Over	<ul style="list-style-type: none"> • +Display over: When the computed result exceeds 99999999 • +Computation over: When the value exceeds approximately $1.79E+308$ in the middle of the computation • When a computation error* occurs (select +Over or –Over.)
–Over	<ul style="list-style-type: none"> • –Display over: When the computed result is less than -99999999 • –Computation over: When the value is less than approximately $-1.79E+308$ in the middle of the computation • When a computation error* occurs (select +Over or –Over.)

* Computation error occurs when the following computation is carried out.

- $X/0$, $SQR(-X)$, or $LOG(-X)$
- If a channel number set to skip or Off is used in the equation
- If a channel number set to Log scale (/LG1 option) is used in the equation

• Rolling Average

The rolling average of the computed result of the equation specified for the computation channel is determined, and the result is the computed data for that channel. The number of samples and the sampling interval can be specified for each computation channel. The rolling average is applied over the time corresponding to “the number of data samples \times the sampling interval.” The maximum sampling interval is 1 hour, and the maximum number of samples is 1500.

• Starting the Computation

You can configure the FX to start the computation when you press the START key.

• Usage of TLOG Computations

TLOG computation determines the sum, maximum, minimum, average, or the difference between the maximum and minimum of a specific channel for each interval determined by a timer.

Timers That Are Used

The timer that is used is assigned to each channel.

Unit of Sum Computation

Set the sum scale when using sum computation (TLOG.SUM).

Select Off, /s, /min, or /h. For details, see page 1-45.

Resetting the TLOG Computed Value

You can select whether to reset the TLOG computed value at each interval. The figure below illustrates the reset operation for sum computation (TLOG.SUM).

Example: Result of the TLOG.SUM computation

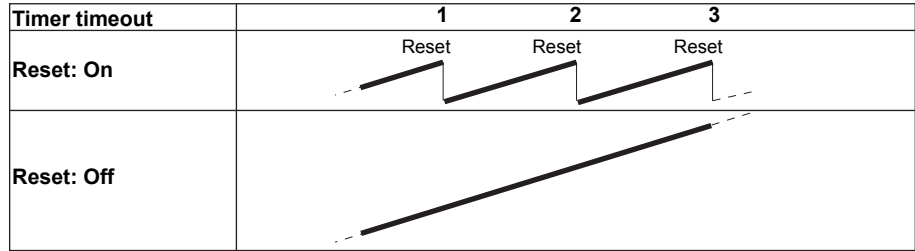

When reset is On, the sum value is calculated over each interval. When set to Off, the sum value from computation start is calculated.

Power Failure Operation, Handling of Error Data, and Handling of Overflow Data

See “Special Data Handling” in this section.

Report Function

This function is used to create hourly, daily, weekly, and monthly reports. For the setting procedure, see section 9.5.

- **Report Data Types**

You can select from four types among maximum value, minimum value, average value, sum value, and instantaneous value. Report data is calculated from the measured values that have been sampled at the scan interval.

- **Report Type**

Type	Description
Hourly report	Creates report data every hour on the hour for the previous one hour.
Daily report	Creates report data every day at a specified time for the previous one day.
Weekly report	Creates report data every week at a specified time at a specified day of the week for the previous one week.
Monthly report	Creates report data every month at a specified time at a specified day for the previous one month.

- **Combinations of Reports That Can Be Created**

You can select from hourly reports only, daily reports only, hourly and daily reports, daily and weekly reports, and daily and monthly reports.

- **Source Channels**

You can select from measurement channels and computation channels. The report data are not created for channels that are set to **Skip** or **Off**.

Model	Number of channels
FX1002 and FX1004	12
FX1006, FX1008, FX1010, and FX1012	24

1.8 Computation and Report Functions (/M1, /PM1, /PWR1, and /PWR5 options)

- **Unit of Sum Computation**

In the sum computation, data are summed over the scan interval. However, for flow values that have units /s, /min, /h, or /day a simple summation results in the actual value not matching the computed result, because the scan interval and the unit of the input values are different. In such cases, set the sum scale to match the unit of the input value. In effect, the sum value with the same unit as that of the input value is calculated.

For example, if the scan interval is 2 s, and the input value is 100 m³/min, a simple summation would add 100 every 2 s resulting in 3000 after one minute. However, if the sum scale is set to /min, then 2 s/60 s is multiplied every scan interval before the value is added giving a result that has an m³/min unit.

The following converting equations are used to compute the sum. The unit of the scan interval is seconds.

Off: $\Sigma(\text{measured data every scan interval})$

/s: $\Sigma(\text{measured data every scan interval}) \times \text{scan interval}$

/min: $\Sigma(\text{measured data every scan interval}) \times \text{scan interval}/60$

/h: $\Sigma(\text{measured data every scan interval}) \times \text{scan interval}/3600$

/day: $\Sigma(\text{measured data every scan interval}) \times \text{scan interval}/86400$

- **Displaying the Report Data**

You can display the report data using keys.

For the operating procedure, see section 4.5.

- **Saving the Report Data**

See section 1.4, "Data Storage Function."

- **Numeric Display and Recording**

The numeric range of the report data is from -9999999 to 99999999 excluding the decimal point (except -3.4E+38 to 3.4E+38 for sum values).

For the data handling of special cases, see "Special Data Handling" in this section.

For details on the report file format, see appendix 3.

Special Data Handling

This section explains the handling of special data in TLOG computation, CLOG computation, and reports.

- **Power Failure Operation (TLOG and Reports)**

If a power failure occurs when the report function is enabled or in the middle of the TLOG computation, the report operation and TLOG computation resume when the FX recovers from the power failure. The operation varies depending on whether the FX recovers from the power failure before or after the time to create a report or TLOG data.

Time of Recovery	Operation
After the time to create the data	The report or TLOG data is created immediately after the FX recovers. The measured data up to the time of the power failure is used. At the time the next report or TLOG data is created, the data after the recovery is used.
Before the time to create the data	After the FX recovers, report or TLOG data is created at the normal time to create the data. The measured data excluding the power failure period is used.

- **Error Data Handling (TLOG, CLOG, and Reports)**

If an error occurs in the channel data, the error data is discarded, and the computation continues. If all the data are in error, an error results.

The following types of data are considered error data.

- Channels set to skip or Off.
- The measured result on a measurement channels is error (A/D converter failure, etc.).
- The input of the measurement channel is in a burnout condition.
- When an error value is returned as the computed result on a computation channel.
- Channels that are set to Log scale (/LG1 option).

- **Handling of Overflow Data**

* Refers to over range on a measurement channel and computation overflow on a computation channel.

For TLOG, CLOG, and Reports

When the channel data is overflow data, the FX handles the data as follows:

Computation Type	Description
Average value or sum value	Set the handling to ERROR, SKIP, or LIMIT. ERROR: Considers the data to be a computation error. SKIP: Discards the overflow data and continues the computation. LIMIT: Replaces the data with the limit value and continues the computation. The limit value is the span upper or lower limit or the scale upper or lower limit of the channel.
Maximum, minimum, Maximum – minimum	Set the handling to OVER or SKIP. OVER: Computes by using the overflow data. SKIP: Discards the overflow data and continues the computation.

For Multiplication and Relation Computation EQ and NE

Computation Type	Computation	Computed Result
Multiplication	0*(+Over)	0
	0*(-Over)	0
	(+Over)*0	0
	(-Over)*0	0
.EQ.	(+Over).EQ.(+Over)	1
	(-Over).EQ.(-Over)	1
.NE.	(+Over).NE.(+Over)	0
	(-Over).NE.(-Over)	0

1.9 FAIL/Status Output Function (/F1 Option)

FAIL Output

When a failure occurs in the FX CPU, the FX generates a relay contact signal (1 signal). The relay is energized when the CPU is normal and de-energizes when a CPU failure occurs. Therefore, relay output is carried out also when the power is turned OFF (including a power failure). You cannot change this behavior.

Relay Operation

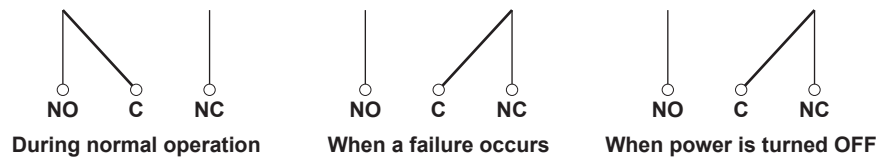

If a failure occurs, contact your nearest YOKOGAWA dealer.

Status Output

Outputs the status below with a relay contact signal (1 relay). The relay is energized when the status occurs. You cannot change this behavior.

For the setting procedure, see section 2.9.

Status	Description	Corrective Action
Status of the internal memory or CF card/SD card	Error in the internal memory.	Contact your nearest YOKOGAWA dealer.
	When the auto save function to the CF card/SD card is On.	
	<ul style="list-style-type: none"> The free space on the CF card/SD card dropped to 10% of the total size (only when the media FIFO (see section 1.4) is disabled). Error in the CF card/SD card. 	<ul style="list-style-type: none"> Replace the CF card/SD card. Replace the CF card/SD card with a normal one. Format^{*1} the CF card/SD card (the CF card/SD card data will be deleted).
	However, the status of the internal memory is output when the CF card/SD card is not inserted.	Insert a CF card/SD card.
	<ul style="list-style-type: none"> 10 MB or less of available space^{*2} remaining in internal memory. The number of files in internal memory for which Auto Save to the CF card/SD card has not been completed has exceeded 390. 	
	When the auto save function to the CF card/SD card is Off.	
	<ul style="list-style-type: none"> 10 MB or less of available space^{*2} remaining in internal memory. The number of files in internal memory for which Manual Save has not been completed has exceeded 390. 	Save the data in the internal memory to the CF card/SD card.
Measurement error	Error in the A/D converter.	Contact your nearest YOKOGAWA dealer.
	Burnout is detected.	Replace the thermocouple that has burned out.
Communication error	A Modbus master or Modbus client communication error occurred.	Check the error in the Modbus master or Modbus client screen and carry out the corrective action.
Memory stop	When the memory sampling is stopped.	Start the data acquisition.

*1 You cannot format SD cards on the FX. See section 6.7.

*2 The internal memory's "available space" refers to the following quantities.

- Unused regions
- Regions of data for which Auto Save or Manual Save (see page 1-28) has been completed.

1.9 FAIL/Status Output Function (/F1 Option)

Relay Operation

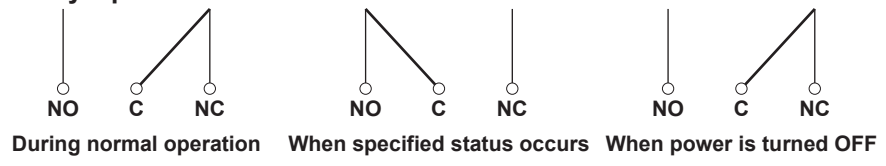

1.10 Other Functions

Time Related Functions

- **Time Correction**

The FX internal clock can be changed in the following ways.

Method	Description
Key operation	Sets the FX internal clock to the specified time.
Event action function (clock synchronization using remote control signals)	Sets the FX internal clock to the nearest hour.
SNTP client function	Sets the FX internal clock to the time retrieved from an SNTP server.

Time Correction Operation

The time correction operation varies depending on whether memory sampling is in progress.

Status	Operation
Memory sampling stopped	The FX internal clock is changed immediately.
Memory sampling	The FX internal clock is gradually corrected. While the time is being gradually adjusted, the date/time in the status display section is displayed in yellow.

Operation of Gradually Correcting the Internal Clock

If the time deviation between the time of the FX internal clock and the correct time (the specified time) is within a specified value, the FX clock is adjusted gradually at a rate of 40 ms per second. Otherwise, the clock is corrected immediately. The maximum value of time deviation (t_m in the figure below) can be selected in the range of 10 s to 5 min. However, if the clock is being adjusted using the event action function (clock synchronization using remote control signals), only when the difference between the current time and the nearest "on the hour" hour is less than or equal to the preset value is the clock gradually adjusted to the hour (see section 1.6).

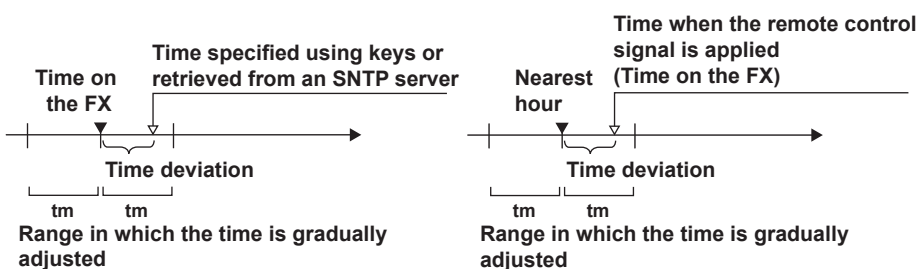

Example: When changing the time to 12 hours 55 minutes 35 seconds when the internal clock is 12 hours 55 minutes 32 seconds
The time deviation of 3 seconds is adjusted 40 ms per second. The internal clock will be synchronized to the specified time 75 seconds later.

- **Date Format**

You can select from the following ways of displaying the date: 2011/09/28, 09/28/2011, 28/09/2011, and 28.09.2011.

For the setting procedure, see section 2.4.

- **Time Zone**

Set the time difference between the location where the FX is used and GMT.

For the setting procedure, see section 2.2.

- **DST (Daylight Saving Time)**

If you are using the FX in an area with daylight saving time, enter the daylight saving time starting and ending dates, and the FX will automatically change the time accordingly.

For the setting procedure, see section 2.1.

System Display

This displays the total number of inputs on the FX, the size of the internal memory, the communication functions, the external storage drive, the options, the MAC address, and the firmware version number.

For the operating procedure, see section 2.5.

Language

The displayed language can be set to English, Japanese, German, French, Chinese, Italian, Spanish, Portuguese, Russian, and Korean.

For the setting procedure, see section 2.6.

24 VDC Power Supply for Transmitter (/TPS2 or /TPS4 Option)

Provides 24-VDC power supply to up to two (/TPS2) or four (/TPS4) two-wire system transmitters. The measured values of the transmitter correspond to a current signal of 4 to 20 mA on the same cable. Therefore, the signal can be connected to the FX input terminal and displayed.

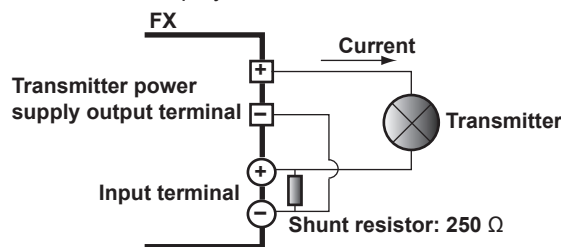

USB Interface (/USB1 option)

You can connect a keyboard or a USB flash memory device to the USB port on the front of the FX.

- You can operate the FX using a keyboard.
- You can save measured data and setup data to the USB flash memory and also load from it.

For the operating procedure, see sections 2.10 and 2.11.

2.1 Setting the Date/Time

Set the date/time.

Setup Screen

- **Date/Time**
Press **MENU** (to switch to setting mode), and select the **Menu** tab > **Date/Time** > **Time Settings**.



- **DST**
Press **MENU** (to switch to setting mode), and select the **Menu** tab > **Date/Time** > **Daylight Saving Time**.

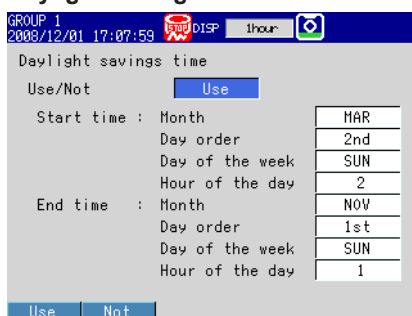

Setup Items

- **Time set**
Enter the date and time, and press **DISP/ENTER**.
- **Daylight savings time > Use/Not**
To set a daylight saving time period, select **Use**.
- **Daylight savings time > Start time**
Specify the date and time when daylight saving time starts.

Item	Description
Month	Specify the month.
Day order (week order)	Specify the week within the month. Specify Last for the last week in the month.
Day of the week	Specify the day of the week.
Hour of the day	Specify the hour using a value from 0 to 23.

- **Daylight savings time > End time**
Specify the date and time when daylight saving time ends. The settings here are the same as those for Start time.

2.2 Setting the Time Difference from GMT

Set the time zone of the region in which the FX will be used. Make sure to set this value if you are using the Internet network functions or the DST function.

Setup Screen

Press **MENU** (to switch to setting mode), hold down **FUNC** for 3 s (to switch to basic setting mode), and select the **Menu** tab > **Time Settings**.

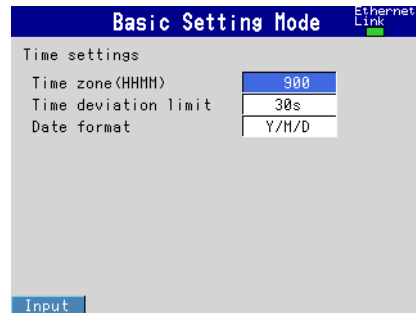

Setup Items

- **Time settings > Time zone(HHMM)**

Set the time zone of the region in which the FX will be used in terms of the time difference from GMT. Specify a value in the range of -1300 to 1300 (where the first two digits denote the hour and the last two digits denote the minute). A negative value indicates that the local time is behind the GMT.

Example: The standard time in Japan is ahead of the GMT by 9 hours. In this case, enter "900."

2.3 Setting the Time Correction Operation during Memory Sampling

This function gradually corrects the time when the time is changed while Memory Sampling is in progress.

For a description of the time correction operation, see section 1.10.

Setup Screen

Press **MENU** (to switch to setting mode), hold down **FUNC** for 3 s (to switch to basic setting mode), and select the **Menu** tab > **Time Settings**.

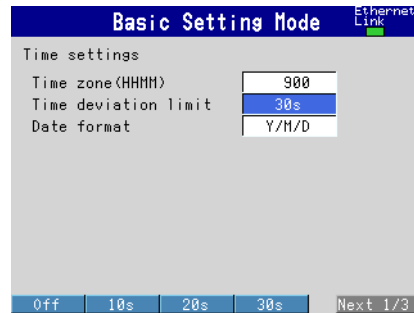

Setup Items

- Time settings > Time deviation limit

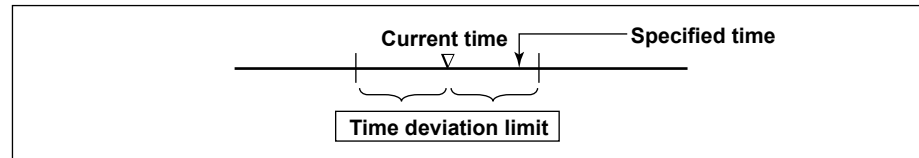

Only when the time deviation between the FX's time and the specified time is within \pm (the value that you specify here), the FX's time gradually corrected. Otherwise, the clock is corrected immediately.

Settings	Description
10 s to 5 min	The time deviation limit.
Off	Disables the function that gradually corrects the time.

Example: If Time deviation limit is set to 10s and the time on the FX is 10:21:15, the time on the FX will be gradually corrected to the specified time if the specified time is between 10:21:05 and 10:21:25.

2.4 Setting the Date Format

Select the display format of the date.

Setup Screen

Press **MENU** (to switch to setting mode), hold down **FUNC** for 3 s (to switch to basic setting mode), and select the **Menu** tab > **Time Settings**.

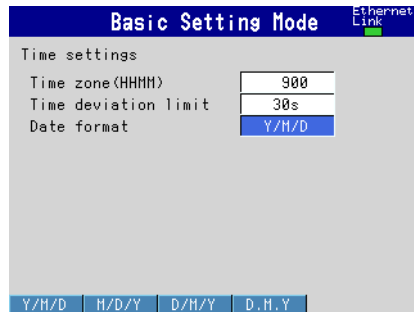

Setup Items

• Time settings > Date format

Settings	Display Example (Example: September 30, 2011)	Time at the grid position in the trend display (example: 8 O'clock on Nov. 30)*
Y/M/D	2011/09/30	09/30 08
M/D/Y	09/30/2011	09/30 08
D.M.Y	30/09/2011	30/09 08
D,M,Y	30.09.2011	30.09 08

* Only if the trend interval is set greater than or equal to 1 h/div.

Applied Range

The format is applied to the date displayed on the screen. It does not change the date format on the setup screen of the date/time, the date in the output data via communications, the date saved along with the data, and the date used in the data file names.

2.5 Viewing the FX Information

The FX information is displayed on the system information screen and the network information screen.

Procedure

- **Displaying System Information Screen**
 1. In the operation mode, press **FUNC**.
The Function menu appears.
 2. Press the **System info** soft key.
The system information screen is displayed.
- **Displaying Network Information Screen (/C7 option)**
 1. In the operation mode, press **FUNC**.
The Function menu appears.
 2. Press the **Network info** soft key.
The network information screen is displayed.

Explanation

• System Information Screen

ANALOG: Number of measurement channels
MATH: Number of computation channels
 (/M1, /PM1, /PWR1, and /PWR5 options)
MEMORY: Internal memory size
Options
MAC address
Version: Firmware version

The following items are displayed:

- Number of measurement channels.
- Number of computation channels.
- Internal memory size
- Option
PWR: /PWR1 or /PWR5
- MAC address
- Firmware version

2.5 Viewing the FX Information

- **Network Information Screen (/C7 option)**

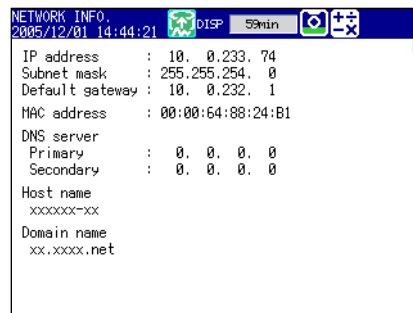

The following items are displayed:

- IP address
- Subnet mask IP address
- Default gateway IP address
- MAC address
- DNS server IP address
- Host name
- Domain name

2.6 Changing the Displayed Language

Set the displayed language.

Setup Screen

Press **MENU** (to switch to setting mode), hold down **FUNC** for 3 s (to switch to basic setting mode), and select the **Environment** tab > **Operating Environment**.

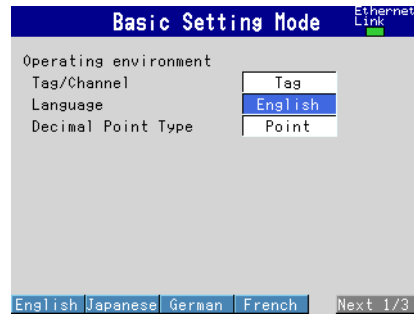

Setup Items

- **Operating environment > Language**
Set the displayed language to **English, Japanese, German, French, Chinese, Italian, Spanish, Portuguese, Russian, or Korean.**

2.7 Setting the LCD Brightness and Backlight Saver

Change the LCD brightness. In addition, set the backlight saver function to prolong the service life of the LCD backlight.

Setup Screen

Press **MENU** (to switch to setting mode), and select the **Menu** tab > **Display** > **LCD**.

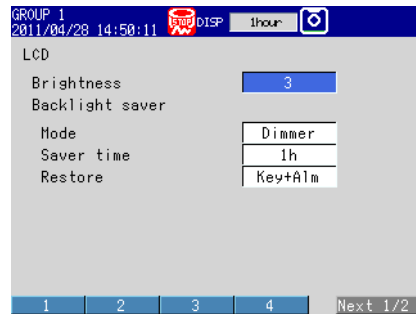

Setup Items

- **LCD > Brightness**

Select a value from 1 to 8 (2 by default). Larger the value, brighter the display becomes.

- **LCD > Backlight saver > Mode**

Settings	Description
Off	Disables the backlight saver.
Dimmer	Dims the display if there is no operation for a given time.
Timeoff	Turns the backlight OFF if there is no operation for a given time.

- **LCD > Backlight saver > Saver time**

Select a value from 1 min to 1 h. If the specified time elapses without any key operation or alarm occurrence, the LCD backlight switches to the specified mode.

- **LCD > Backlight saver > Restore**

Settings	Description
Key	The backlight returns to the original brightness when a key is pressed.
Key+Alm	The backlight returns to the original brightness when a key is pressed or when an alarm occurs.

Note

- If the backlight saver function has dimmed or turned off the backlight, pressing any key on the FX will cause the backlight to return to its original brightness. In this operation, the key does not perform its intended function.
- The degradation of the brightness and the discoloration of the screen (become yellowish) tend to progress faster as the brightness is set higher. Extended use at an unnecessary high setting should be avoided. It is also recommended that you use the backlight saver function.

2.8 Initializing Settings and Clearing the Internal Memory

Initialize the settings to default values. In addition, clear the data in the internal memory. For the default settings, see appendix 4.

Setup Screen

Press **MENU** (to switch to setting mode), hold down **FUNC** for 3 s (to switch to basic setting mode), and select the **File/Initialize** tab¹ > **Initialize**.

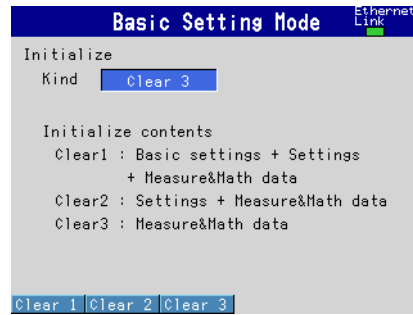

- 1 On FXs that do not have a CF card slot/SD card slot or USB interface (/USB1 option), this is the Initialize tab.

Setup Items

- **Initialize**

Settings	Description
Clear 1	Returns the basic setting mode and setting mode settings to their default values and clears the data in the internal memory (measured data and computed data).
Clear 2	Returns the setting mode settings to their default values and clears the data in the internal memory (measured data and computed data).
Clear 3	Clears the data in internal memory (measured data and computed data).

* Data in internal memory that is cleared: display data, event data, manual sampled data, report data (/M1, /PM1, /PWR1, and /PWR5 options), and log information.

1. Press the **Clear 1**, **Clear 2**, or **Clear 3** soft key.
2. Press **DISP/ENTER**.
A confirmation window opens.
3. Select **Yes** and press **DISP/ENTER**.
The specified operation is executed, and the FX returns to the operation mode.
If you do not want to initialize, select **No** and press **DISP/ENTER**.

2.9 Using the Relay Contact to Output the FX Status (/F1 option)

A signal is output to a dedicated relay when an error occurs in the FX CPU. In addition, a signal is output to a different relay when the specified status occurs. For a description of the FAIL/status output function, see section 1.9.

Setup Screen

- **Status Relay Details**

Press **MENU** (to switch to setting mode), hold down **FUNC** for 3 s (to switch to basic setting mode), and select the **Menu** tab > **Status Relay**.

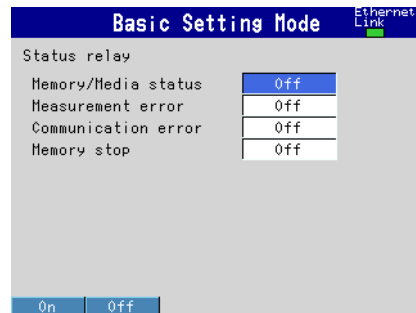

Setup Items

- **Status Relay > Memory/Media status***

On: The status of the internal memory and the CF card/SD card is relayed.

* On FXs that do not have a CF card slot/SD card slot, only Memory status will be relayed.

- **Status Relay > Measurement error**

On: A relay signal is output when a measurement error occurs.

- **Status Relay > Communication error**

On: A relay signal is output when a communication error occurs.

- **Status Relay > Memory stop**

On: A relay signal is output when memory sampling stops.

Procedure

- **FAIL Output**

There are no operations that are required. A signal is output to the relay contact when a CPU error is detected. A signal is also output to the relay contact when the FX is turned off.

- **Status Relay**

A signal is output to the relay contact when a specified status occurs.

2.10 Controlling the FX with a Keyboard (/USB1 option)

This section explains how to connect and use a USB keyboard.

Connecting and Disconnecting a Keyboard

- **Connection**

1. Connect the keyboard to a FX USB port.

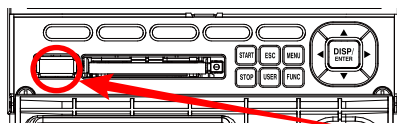

USB port

When a message is displayed informing you that a USB device has been connected, the keyboard is ready to be used.

- **Removal**

Disconnect the keyboard cable from the FX USB port.

Note

- You can connect and disconnect a keyboard at any time, regardless of what is shown on the display and whether the FX is on or off.
- Use a keyboard that matches the FX language setting.
When the FX's display language is set to German or French, the language selection window (prompting you to select between German and English or between French and English) is displayed when you connect a USB keyboard.
- The statuses of the Caps Lock and Num Lock keys are retained even if the USB keyboard is disconnected.

Operating from the Keyboard

Use the keyboard while viewing the FX screen. When an operation can be carried out on the FX, the same operation can be carried out from the keyboard.

Example: Switch to setting mode

When the FX is in operation mode, press Ctrl+M.

The FX switches to setting mode, and the setting menu appears.

- **Mapping of the Keys on the FX to the Keys on the Keyboard**

Keyboard Keys	FX Keys
Keys on the Keyboard 104 Keyboard (US) for the PC	
Enter	DISP/ENTER
←	Left arrow key
↑	Up arrow key
↓	Down arrow key
→	Right arrow key
Num Enter	DISP/ENTER
Esc	ESC
F1 to F5	Soft key 1 to soft key 5
F9	FUNC
F12	Hold down FUNC for 3 seconds
Left-Windows	MENU
Right-Windows	MENU
Ctrl+S	START
Ctrl+P	STOP
Ctrl+U	USER
Ctrl+M	MENU
Tab, Shift+Tab	Arrow keys*

* Press **Tab** to move the cursor to the next item, or **Shift+Tab** to move to the previous item. However, this does not work in the following screens:

Operation screens, Menu screens for Setting mode and Basic setting mode, screens for entering values and characters, "Menu customize" and "Save/Load" screens in Setting mode, and "Load setting, Initialize" screen in Basic setting mode

- **Entering Alphabets, Numbers, and Symbols**

When alphabet characters, numbers, and symbols can be entered on the FX, the same input can be performed from the keyboard. The operations are the same as normal key operations.

Symbols That Can Be Entered Using the Keyboard

You can enter the following symbols. However, symbols that cannot be used on the FX are invalid. For example, the characters *, /, :, and ? cannot be used in the data save destination directory name.

#	%	()	*	+	-	.	/	:	?	@	[]	^	_
---	---	---	---	---	---	---	---	---	---	---	---	---	---	---	---

* Press "A" on the keyboard to enter the temperature degree symbol.

- **Invalid Keys**

Keys enclosed in frames are invalid.

The 104 Keyboard for a PC (US)



2.11 Using USB Flash Memory (/USB1 option)

Connecting/Removing a USB Flash Memory

• Connecting a USB Flash Memory

1. Connect a USB flash memory device to the FX USB port.
After the message, "USB device has been connected." appears, you can use the USB flash memory device.
2. In operation mode, possible operations are shown. Select the desired operation using the **arrow keys** and press **DISP/ENTER**.

When set to auto save

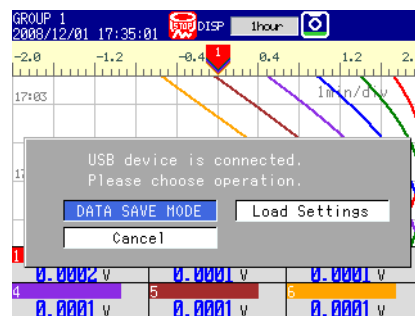

When set to manual save

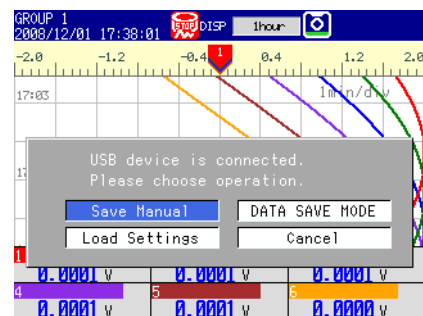

Setting	Description
Save Manual	Saves unsaved data in the internal memory to a USB flash memory device.
DATA SAVE MODE	Switches to the DATA SAVE MODE display. When you select DATA SAVE MODE, the external storage medium to save data to is fixed to the USB memory device. For the procedure to save the data in internal memory, see section 4.8.
Load Settings	Moves to the setup load display of setting mode. For the procedure to load the setup data, see section 6.9. Load Settings will not be displayed: <ul style="list-style-type: none"> • When Media/USB loading is locked (see chapter 8 for details). • When the FX is accessing the external storage medium (formatting, saving, or FTP communication).
Cancel	Closes the operation selection window.

• Removing the USB Flash Memory

1. In the operation mode, press **FUNC**.
The Function menu appears.
2. Press the **Media eject** soft key and then the **USB** soft key.
A message "Media can be removed safely." appears.
3. Remove the USB flash memory.

Note

Be sure to carry out the procedure above when removing the USB flash memory. If you remove the USB memory without performing the above procedure, the data stored on it could be damaged.

Saving and Loading Data

The following data save/load and file operations can be carried out.

- Save/Load setup data files (see section 6.9).
- Save display data and event data files (see sections 4.8 and 6.4).
- Load display data and event data files (see section 6.8).
- List files and delete files (see section 6.7).
- Format (see section 6.7).

2.12 Setting the Decimal Point Type

You can set the decimal point type for the display and files saved in text format.

Setup Screen

Press **MENU** (to switch to setting mode), hold down **FUNC** for 3 s (to switch to basic setting mode), and select the **Environment** tab > **Operating Environment**.

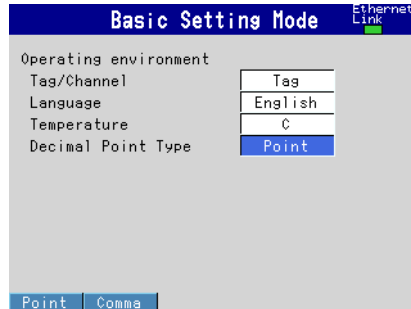

Setup Items

- **Decimal Point Types**

Setting	Display Example
Point	1234.56
Comma	1234,56

Explanation

- **Decimal Point Types**

The decimal point type setting affects the following kinds of files and displays. The decimal point of any file or setting not listed below (the setup screen for example) is displayed using a period.

Type	Item
File output	Manual sampled data file Report file ¹
Display	Trend display Digital display Bar graph display Overview display Historical trend Stacked bar graph Report data display ¹
Web page ²	All channel display
E-mail ²	The instantaneous value data in alarm e-mails and scheduled e-mails. The report data in report e-mails ¹

¹ /M1, /PM1, /PWR1, and /PWR5 options

² /C7 option

3.1 Setting the Scan Interval and the Integration Time of the A/D Converter

Select the scan interval and the integration time of the A/D converter.

For a description of the scan interval and the integration time of the A/D converter, see section 1.1.

Setup Screen

Press **MENU** (to switch to setting mode), hold down **FUNC** for 3 s (to switch to basic setting mode), and select the **Menu** tab > **A/D, Memory**.

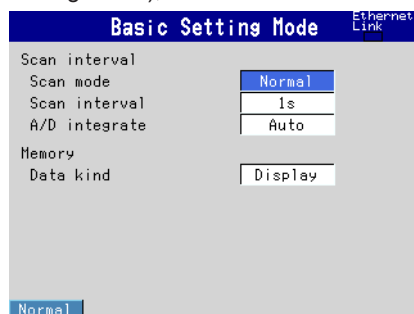

Setup Items

- **Scan interval > Scan mode**
Fixed to **Normal**.
- **Scan interval > Scan interval**
The selectable settings appear.
- **Scan interval > A/D integrate**
Select the A/D integration time as necessary. Only the selectable settings are displayed.

Settings	Description
Auto	The FX automatically detects the power supply frequency and sets the integration time to 16.7 ms for 60 Hz and 20 ms for 50 Hz. Fixed to 20 ms on /P1 models that use the 24 VDC power supply.
50Hz	Sets the integration time to 20 ms.
60Hz	Sets the integration time to 16.7 ms.
100ms	Sets the integration time to 100 ms (when the scan interval is 2 s or 5 s).

3.2 Setting the Burnout Detection and the Reference Junction Compensation of the Thermocouple Input

Set the function that detects burnouts in the sensor for thermocouple input and 1-5V input and the reference junction compensation method of the thermocouple.

Setup Screen

Press **MENU** (to switch to setting mode), hold down **FUNC** for 3 s (to switch to basic setting mode), and select the **Menu** tab > **Burnout, RJC**.

The screenshot shows the 'Basic Setting Mode' screen with the following settings:

- First-CH: 001
- Last-CH: 001
- Burnout set: Off
- RJC Mode: External
- Volt: 0 μV

At the bottom, there are navigation buttons: 'Input', '+1', and '-1'. An 'Ethernet Link' indicator is visible in the top right corner.

Setup Items

- **First-CH, Last-CH**

Select the target channels.

- **Burnout set**

Detects thermocouple and 1-5V input sensor burnouts.

Settings	Description
Off	Does not detect burnouts in the sensor.
Up	When the sensor burns out, the measured result is set to +over range. The measured value displays "Burnout." For 1-5V input, the FX assumes that the sensor has burned out when the measured value exceeds the scale upper limit by 10% of the scale width. (Example: When the measured value is greater than 110 when the scale is from 0 to 100)
Down	When the sensor burns out, the measured result is set to -over range. The measured value displays "Burnout." For 1-5V input, the FX assumes that the sensor has burned out when the measured value falls below the scale upper limit by 5% of the scale width. (Example: When the measured value is less than -5 when the scale is from 0 to 100)

- **RJC > Mode**

Sets the reference junction compensation method of the thermocouple input. Select **Internal** or **External**.

Settings	Description
Internal	Uses the reference junction compensation function of the FX.
External	Uses an external reference junction compensation function. When set to External , Volt is displayed.

- **RJC > Volt**

Settings	Description
Volt	The compensation voltage to be added to the input. Set the value in the range of -20000 μV to 20000 μV .

3.3 Setting the Input Range

Set the input range for each channel.

For the power monitor (/PWR1 or /PWR5 option) input setting procedure, see section 3.12, "Measuring Power."

For the log scale (/LG1 option) range setting procedure, see section 3.13, "Using the Log Scale to Perform Measurements."

Setup Screen

- **Temperature Unit**

Press **MENU** (to switch to setting mode), hold down **FUNC** for 3 s (to switch to basic setting mode), and select the **Environment** tab > **Operating Environment**.

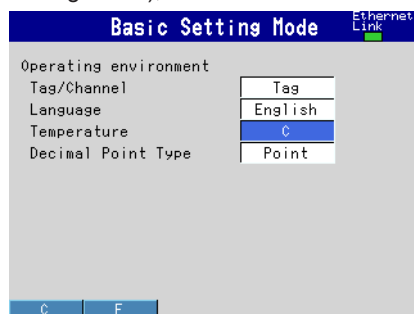

- **Input Range for Each Channel**

Press **MENU** (to switch to setting mode), and select the **Menu** tab > **Meas channel** > **Range, Alarm**.

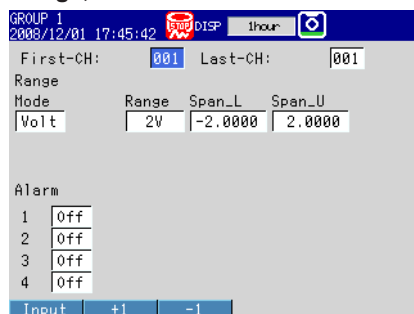

Setup Items

- **Temperature**

Select the temperature unit. The setting is applied to all temperature measurement channels.

Settings	Description
C	Use Celsius
F	Use Fahrenheit

3.3 Setting the Input Range

- **First-CH, Last-CH**
Select the target channels.

- **Range > Mode**

Settings	Description
Skip	Not measured.
Volt, TC, RTD, DI, 1-5V	Input type. Represents DC voltage, thermocouple, RTD, ON/OFF input, and 1-5V inputs, respectively.
Delta, Scale, Sqrt	Difference computation, linear scaling, and square root computation.

Set the items with check marks in the table below according to the mode value.

Setup Item	Mode								
	Volt	TC	RTD	DI	Delta	Scale	Sqrt	1-5V	Skip
Type					✓	✓			
Range	✓	✓	✓	✓	✓	✓	✓	✓	
Span Lower	✓	✓	✓	✓	✓	✓	✓	✓	
Span Upper	✓	✓	✓	✓	✓	✓	✓	✓	
Scale Lower						✓	✓	✓	
Scale Upper						✓	✓	✓	
Unit						✓	✓	✓	
Ref.CH					✓				
Low-cut							✓	✓	
Low-cut value							✓		

- **Range > Type**

Input type when **Mode** is **Delta** or **Scale**. See the description on Mode above.

- **Range > Range**

Input type details.

Setting	Input Type	Notes	Setting	Input Type	Notes
20mV	-20.000 mV to 20.000 mVDC	Standard	R	Type R	Standard
60mV	-60.00 mV to 60.00 mVDC		S	Type S	
200mV	-200.00 mV to 200.00 mVDC		B	Type B	
1V	-1.0000 V to 1.0000 VDC		K	Type K	
2V	-2.0000 V to 2.0000 VDC		E	Type E	
6V	-6.000 V to 6.000 VDC		J	Type J	
20V	-20.000 V to 20.000 VDC		T	Type T	
50V	-50.00 V to 50.00 VDC		N	Type N	
Pt	Pt100		W	Type W	
JPt	JPt100		L	Type L	
Level	On/off (voltage)		U	Type U	
Contact	On/off (contact)		WRe	Type WRe	
1-5V	0.800 V to 5.200 V				

Setting	Input Type	Notes
Kp	Kp vs Au7Fe	/N3F option
PLATI	PLATINEL	
PR	PR40-20	
NiMo	NiNiMo	
W/WRe	W/WRe26	
N2	Type N (AWG14)	
XK	XK GOST	
Ni1	Ni100 (SAMA)	
Ni2	Ni100 (DIN)	
Ni3	Ni120	
Pt100G	Pt100 GOST	
Cu100G	Cu100 GOST	
Cu50G	Cu50 GOST	
Pt200W	Pt200 (WEED)	

- **Range > Span_L, Span_U**

Input range. The selectable range is displayed on the screen.

Note

- You cannot set the same value to **Span_L** and **Span_U**.
- When the **Mode** is **1-5V** or **Sqrt**, **Span_L** must be less than **Span_U**.

- **Range > Scale_L, Scale_U**

Input range after converting the unit.

The selectable range is from -30000 to 30000. The decimal place is determined by the **Scale_L** setting. It can be set to the following positions: "X.XXXX," "XX.XXX," "XXX.XX," "XXXX.X," or "XXXXX."

Note

- The FX converts the measured value to a value within the range set by the **Scale_L** and **Scale_U** values with their decimal points removed. For example, if the scale setting is "-5 to 5," the value is converted to a value within the span of "10"; if the scale setting is "-5.0 to 5.0," the value is converted to a value within a span of "100." In this case, the resolution of the value converted to a span of "10" is lower than the value converted to a span of "100." To prevent the display from becoming rough, it is recommended that the scale be set so that this value is greater than 100.
- You cannot set the same value to **Scale_L** and **Scale_U**.
- When the **Mode** is **1-5V** or **Sqrt**, **Scale_L** must be less than **Scale_U**.

3.3 Setting the Input Range

- **Range > Unit**

Set the unit (up to 6 characters, $\boxed{\text{Aa}\#\text{1}}$).

- **Range > Ref. CH**

The reference channel for difference computation.

- * Note that if you set the reference channel to a channel that is set to log scale (/LG1 option), an error will be returned as the computation result.

- **Range > Low-cut**

Select **On** to use the low-cut function.

- * The low-cut value for 1 to 5 V input is fixed to 0% value of the input span.

- **Range > Value**

On a square root computation channel, set the low-cut value in the range of 0.0% to 5.0% of the input span.

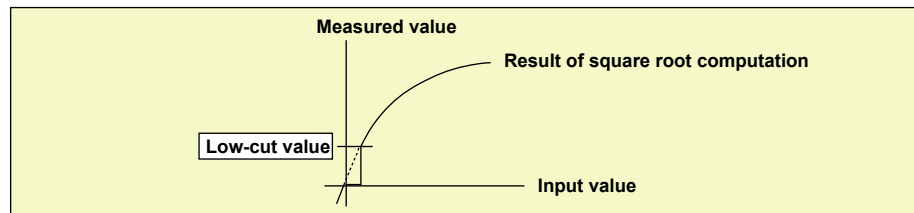

3.4 Setting the Moving Average of the Input

Set the moving average function of the measurement channel. This function suppresses the effects of noise.

For a description of the function, see section 1.1.

Setup Screen

Press **MENU** (to switch to setting mode), and select the **Menu tab > Meas channel > Moving average**.

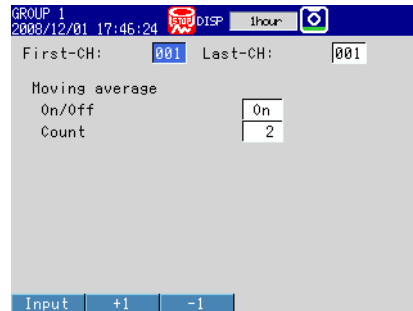

Setup Items

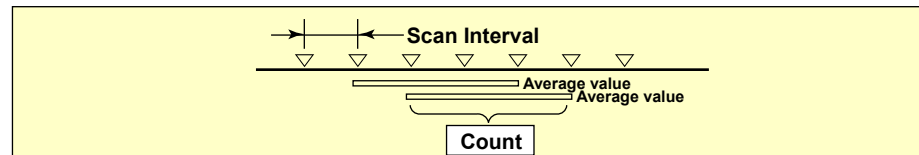

- **First-CH, Last-CH**
Select the target channels.
- **Moving average > On/Off**
To use moving average, select **On**.
- **Moving average > Count**
Set the number of data points of the moving average in the range of 2 to 400.

3.5 Setting the Auxiliary Alarm Function

Set the alarm display and operation of the output relays (/A[] and /A4A options).
For a description of the function, see section 1.2.

Setup Screen

Press **MENU** (to switch to setting mode), hold down **FUNC** for 3 s (to switch to basic setting mode), and select the **Menu** tab > **Alarm** > **Basic settings; Switch, Relay; or Hysteresis**.

- **Basic settings**

The screenshot shows the 'Basic Setting Mode' screen with the 'Basic setting' menu. The 'Ethernet Link' indicator is green. The settings are as follows:

Reflash	Off
Rate of change	
Decrease	1
Increase	1
Indicator	Nonhold

At the bottom, there are buttons for 'On' and 'Off'.

- **Switch, Relay**

The screenshot shows the 'Basic Setting Mode' screen with the 'Switch, Relay' menu. The 'Ethernet Link' indicator is green. The settings are as follows:

Internal Switch	None
AND	None
Relay	
AND	None
Action	Energize
Hold	Nonhold
Relay Action on ACK	Normal

At the bottom, there are buttons for 'None', 'S01', 'S01-S02', 'S01-S03', and 'Next 1/8'.

- **Hysteresis**

The screenshot shows the 'Basic Setting Mode' screen with the 'Hysteresis' menu. The 'Ethernet Link' indicator is green. The settings are as follows:

Hysteresis	
Meas CH	
High/Low	0.5 %
Delta High/Low	0.0 %
Math CH	
High/Low	0.0 %

At the bottom, there is an 'Input' button.

Setup Items

- **Basic settings > Reflash**

To set the reflash operation on the alarm output relay, select **On**. The reflash function is set on the first three output relays.

Setting	Description
Off	Reflash is not used.
On	Reflash is used. The relays are deactivated for approximately 500 ms.

- **Basic settings > Rate of change**

- **Decrease**

Set the interval for the rate-of-change calculation of the low limit on rate-of-change alarm in terms of the number of sampled data points (1 to 32). The actual interval is obtained by multiplying the value specified here by the scan interval.

- **Increase**

Set the interval for the rate-of-change calculation of the high limit on rate-of-change alarm in the same manner as the interval for the low limit on rate-of-change alarm.

- **Basic setting > Indicator**

You can choose to make the alarm displays behave in the following ways.

Settings	Description
Nonhold	Clears the alarm indication when the alarm condition is released (returns to normal condition).
Hold	Holds the alarm indication until an alarm acknowledge operation is performed.

- **Internal Switch > AND**

Select the internal switches that are to operate using AND logic. Set the range of internal switches (from the first internal switch) to take the AND logic. All subsequent switches will be set to OR logic.

- **Relay > AND**

Select the relays that are to operate using AND logic. Set the range of relays (from the first alarm relay) to take the AND logic. All subsequent relays will be set to OR logic. Available settings are **None**, **I01** (I01 only), **I01-I02** (I01 and I02), **I01-I03** (I01 to I03), etc. Only alarm output relays that are installed are valid.

Note

When reflash is turned ON, the operation of the first three output relays is fixed to OR logic. Specifying **AND** produces no effect.

- **Relay > Action**

Select whether the alarm output relay is energized or de-energized when an alarm occurs. The setting applies to all alarm output relays.

- **Relay > Hold**

You can choose to make the alarm output relays behave in the following ways. This setting applies to all relays.

Settings	Description
Nonhold	Turns the output relay OFF when the alarm condition is released (returns to normal condition).
Hold	Holds the output relay at ON until an alarm acknowledge operation is performed.

Note

When reflash is turned ON, the operation of the first three output relays is set to nonhold. Specifying **Hold** produces no effect.

- **Relay > Relay Action on Ack**

You can select the relay output status that is enabled after the AlarmACK operation from the following two settings.

Settings	Description
Normal	The relay is deactivated when the alarm ACK operation is executed. If the condition for activating the alarm output relay is met in the next scan interval, the relay is activated. This operation is valid only when the alarm output relay is set to Hold .
Reset	The relay is deactivated when the alarm ACK operation is executed. If a new condition for activating the alarm output relay is met, the relay is activated.

3.5 Setting the Auxiliary Alarm Function

An example of the relay action when alarm ACK is executed is shown below. This example is for the case when the output relay **AND** item is set to **None**.

Normal

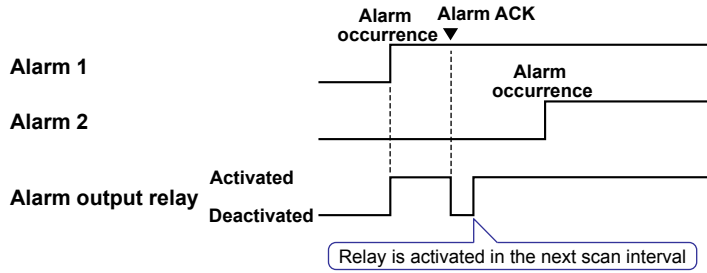

Reset

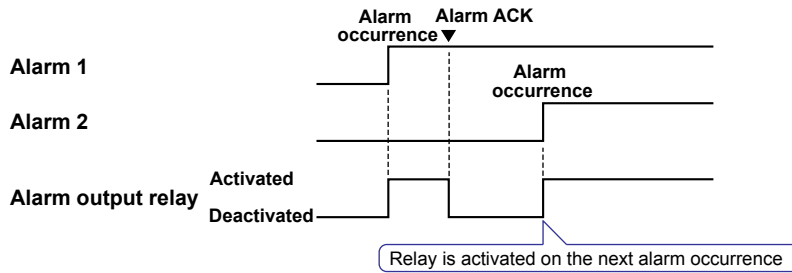

- **Hysteresis > Meas CH**
 - **High/Low**
Sets the hysteresis width of the alarm occurrence/release of the high/low limit alarm specified on measurement channels.
Selectable range: 0.0% to 5.0% of the span or scaling width
If you set a limit to a channel that is set to log scale (/LG1 option), the alarm hysteresis will be fixed to 0%.
 - **Delta High/Low**
Sets the hysteresis width of the alarm occurrence/release of the difference high/low limit alarm specified on measurement channels.
Selectable range: 0.0% to 5.0% of the span
- **Hysteresis > Math CH (/M1, /PM1, /PWR1, and /PWR5 options)**
Sets the hysteresis width of the alarm occurrence/release of the high/low limit alarm specified on computation channels.
Selectable range: 0.0% to 5.0% of the measurement span

3.6 Hiding the Alarm Indication

Select whether to enable the alarm hide function.
For a description of the function, see section 1.2.

Setup Screen

Press **MENU** (to switch to setting mode), hold down **FUNC** for 3 s (to switch to basic setting mode), and select the **Environment** tab > **Input, Alarm**

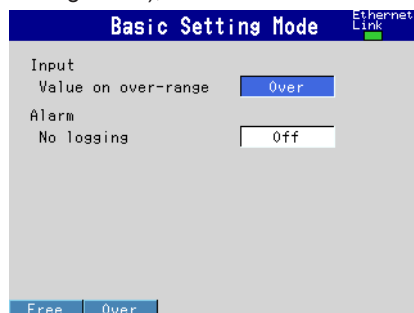

Setup Items

- **Alarm action > No logging**

To enable the function that turns off the alarm indicator and logging, select **On**. The **Detect** setup item is displayed in the alarm setting screen (see section 3.7).

This function disables the alarm indicator and the logging of alarm events to the alarm summary.

- **Settings for Each Channel and Each Alarm**

See section 3.7.

3.7 Setting Alarms on Channels

Set the alarms after setting the range. All alarm settings of a channel are cancelled in the following cases.

- * For details on the log scale (/LG1 option) alarm settings, see section 3.13, "Using the Log Scale to Perform Measurements."
- When the input type (**Volt**, **TC**, etc.) is changed.
- When the input range is changed.
- When the upper or lower limit of the span or scale is changed on channels that are set to linear scale, square root computation, or 1-5 V (including changes in the decimal point position).

For a description of the function, see section 1.2.

Setup Screen

- **Alarms for Each Channel**

Press **MENU** (to switch to setting mode), and select the **Menu** tab > **Meas channel** > **Range, Alarm**.

Mode	Range	Span_L	Span_U
Volt	2V	-2.0000	2.0000

1	Type	Value	Relay	No.	Detect
On	H	0.5000	On	I01	On
Off	H	0.5000	On	I01	On
Off	H	0.5000	On	I01	On
Off	H	0.5000	On	I01	On

- **Alarm Delay Time**

Press **MENU** (to switch to setting mode), and select the **Menu** tab > **Meas channel** > **Tag, Memory, Delay**.

Tag
Characters

Memory sample
On/Off On

Alarm delay
Time

Setup Items

- **First-CH, Last-CH**

Select the target channels. The target channels are common with the other items that are displayed on the screen.

- **Alarm > 1, 2, 3, and 4**

For each alarm, 1 to 4, select **On** to enable it.

- **Alarm > Type**

Select the alarm type.

Settings Name	Description
H	High limit alarm
L	Low limit alarm
h	Difference high limit alarm Can be specified on channels set to difference computation.
l	Difference low limit alarm Can be specified on channels set to difference computation.
R	High limit on rate-of-change alarm
r	Low limit on rate-of-change alarm
T	Delay high limit alarm
t	Delay low limit alarm

Alarms on channels set to difference computation are inserted at the following positions.

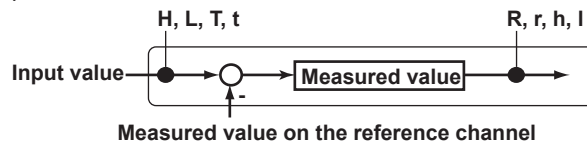

- **Alarm > Value**

Set the alarm value for the selected alarm type.

When the Mode of the Channel Is Set to Volt, TC, RTD, or DI

Type	Value	Example of a Range of Alarm Values
H, L	Value in the measurable range	–2.0000 to 2.0000 V for 2 V range
R, r	1 digit to the upper limit of the width of the measurable range However, less than or equal to 30000 excluding the decimal point.	0.0001 to 3.0000 V for 2 V range 0.1 to 1760.0°C for thermocouple type R
T, t	Same as H and L.	Same as H and L.

When the Mode of the Channel Is Set to Delta

Type	Value	Example of a Range of Alarm Values
H, L	Value in the measurable range	–2.0000 to 2.0000 V for 2 V range
h, l	Value in the measurable range	–1760.0 to 1760.0°C for thermocouple type R
R, r	1 digit to the width of the measurable range However, less than or equal to 30000 excluding the decimal point.	0.0001 to 3.0000 V for 2 V range 0.1 to 1760.0°C for thermocouple type R
T, t	Same as H and L.	Same as H and L.

When the Mode of the Channel Is Set to Scale, Sqrt, or 1-5V

Type	Value	Example of a Range of Alarm Values
H, L	–5% to 105% of the scale width. However, within –30000 to 30000 excluding the decimal point.	–5.0 to 105.0 when the scale is 0.0 to 100.0 –120.00 to 300.00 when the scale is –100.00 to 300.00
R, r	Within 1 to 30000 excluding the decimal point.	0.1 to 3000.0 when the scale is 0.0 to 100.0 0.01 to 300.00 when the scale is –100.00 to 300.00
T, t	Same as H and L.	Same as H and L.

3.7 Setting Alarms on Channels

- **Alarm > Relay**
Select whether to turn **On** or **Off** the relay output.
- **Alarm > No.**
Set the output relay number or internal switch number when performing relay output.
- **Alarm > Detect**
This item appears when the alarm hide function (see section 3.6) is turned **On**. Select whether to show or hide the alarm indication when an alarm occurs. If set to **Off**, a signal is output to the alarm output relay or internal switch when an alarm occurs, but it is not indicated on the screen. The alarm is also not recorded in the alarm summary.
- **Alarm delay > Time (for delay high/low limit alarms)**
Set the alarm delay time to an integer in the range of 1 to 3600 s.

Note

- The alarm delay time takes on a value that is an integer multiple of the scan interval. For example, if the alarm delay time is set to 5 s when the scan interval is 2 s, the actual delay time is 6 s.
 - The delay alarm has the following special operations.
 - If the computation is stopped in a condition in which the computed value is exceeding the alarm setting when a delay alarm is set on a computation channel, the alarm is turned On after the specified period (delay time) elapses.
 - The alarm detection operation is reset if a power failure occurs. The operation restarts after the power recovers.
 - If the alarm setting of the delay high limit alarm is changed when an alarm is already activated and the input is greater than or equal to the new setting, the alarm continues. For all other cases, the alarm detection operation starts at the new setting. This is also true for the delay low limit alarm.
-

3.8 Releasing the Alarm Output (Alarm ACK Operation)

This operation is valid when the FX is set as follows:

- When **Indicator** is set to **Hold** in the basic setting mode.
- When **Relay Hold** is set to **Hold** and **Relay action on ACK** is set to **Normal** in the basic setting mode.
- When **Relay action on ACK** is set to **Reset** in the basic setting mode.

For the Hold and Relay Action on ACK setting procedures, see section 3.5.

Procedure

This operation is carried out after an alarm occurs.

- 1.** In Operation Mode, press **FUNC**.
The Function menu appears.
- 2.** Press the **AlarmACK** soft key.
The alarm output is released.

Explanation

- **Alarm Acknowledge (ACK) Operation**

When an alarm acknowledge operation is carried out, the indicators and outputs (relays and switches) of all activated alarms are cleared.

3.9 Performing Calibration Correction (/CC1 Option)

The input value is calibrated using segments, and the result is used as a measured value.

- * You cannot specify calibration correction for a channel whose log scale (/LG1 option) mode is set to LogType2.

For a description of the function, see section 1.1.

Setup Screen

Press **MENU** (to switch to setting mode), and select the **Menu** tab > **Meas channel** > **Calibration correction**.

	MES val	True val
1	0.0000	0.0000
2	0.5000	0.5100
3	1.0000	1.0200
4	1.5000	1.5500
5	2.0000	1.9900

Setup Items

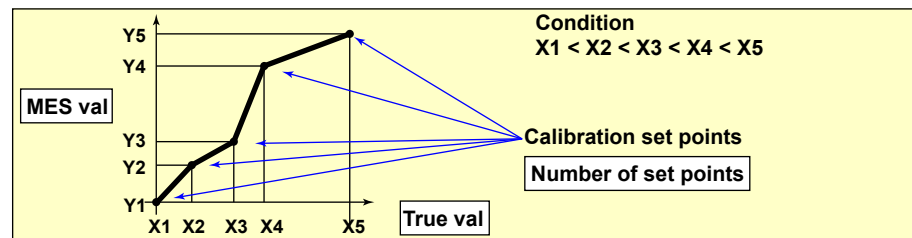

- **First-CH, Last-CH**
Select the target channels. You can set consecutive channels whose range is set to the same value as the first channel.
- **Number of set points**
Select the number of points that make up the segments (including the start and end points) in the range of 2 to 16.
To disable calibration correction, select **Off**.
- **Number of set points > MES val, True val**
Press the **Input** soft key and enter the value.
For the MES value, set a value that is greater than the previous value.
Press the **Measure** soft key to set the measured value at that point to **MES val**. If you press the **Measure** soft key when setting multiple channels simultaneously, the measured value of the first channel are set to the **MES val** of all channels.

Selectable Range of MES and True Values

- **Channels on which linear scaling is specified**
–30000 to 30000 (the decimal place is the same setting as the scale value)
- **Other channels**
Value in the measurable range of the selected range
Example: –2.0000 to 2.0000 for 2 V range

Note

- The calibration correction setting is set to Off if you change the **Mode** or **Range** setting.
- Calibration correction cannot be specified on channels set to **Skip**.

3.10 Counting Pulses (/PM1 Option)

The pulses applied to the pulse input terminal are counted on a computation channel. For a description of the function, see section 1.1.

Setup Screen

Press **MENU** (to switch to setting mode), and select the **Menu** tab > **Math channel** > **Expression, Alarm**

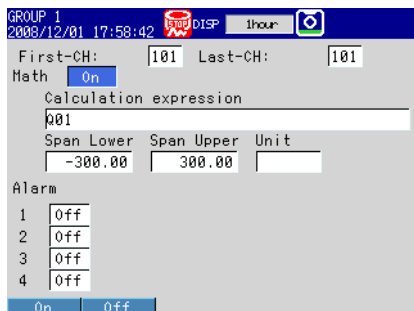

Setup Items

- **First-CH, Last-CH**
Select the target computation channels.
- **Math**
Select **On**.
- **Math > Calculation expression**
Enter the equation using symbols.
Q01 to Q08: Displays the number of pulses per second.
P01 to P08: Displays the number of pulses per scan interval.
* The numbers 01 to 08 correspond to the pulse input terminal numbers.
For the procedure to set the computation channels, see section 9.1.

The procedure is explained below using examples.

- **Example 1: Pulse Sum Value**
Display the sum value of the pulse signal applied to pulse input terminal number 6.

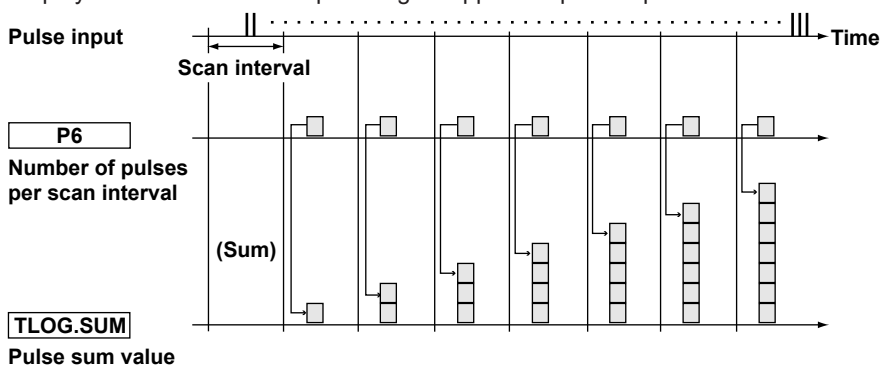

Expression

The following table shows which calculation expression to assign to which computation channel. Set the span lower/upper limit and unit according to the application.

Channel	Expression	Description
101	TLOG.SUM(P6)	Sum of the number of pulses per scan interval

3.10 Counting Pulses (/PM1 Option)

- **Example 2: Number of Pulses per Minute**

Using the FX1002 (scan interval set to 250 ms), count the number of pulses received by pulse input terminal 6, and calculate the number of pulses per minute.

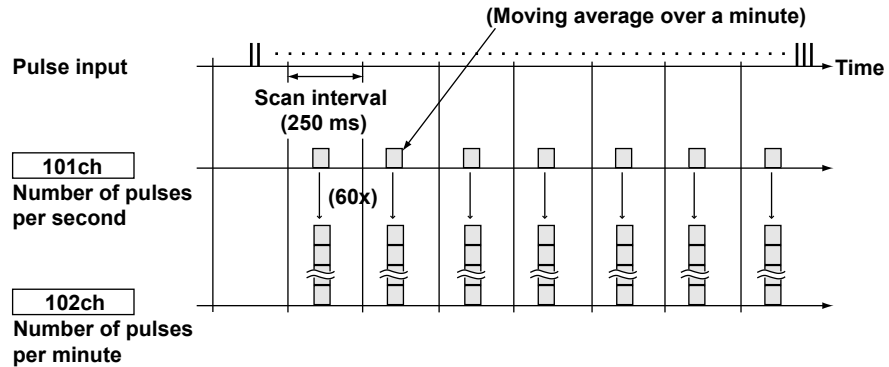

Expression

Assign the computation channel as shown below and set the expressions. Set the span lower/upper limit and unit according to the application.

Channel	Expression	Description
101	Q6	Number of pulses per second
102	101*K01	Number of pulses per minute

Channel	Value	Description
K01	60	Coefficient for converting the number of pulses per second to the number of pulses per minute

Channel	Rolling average	Description
101	Sampling interval: 1s	Moving average over a minute
	Number of samples: 60	

Channel

The computation is performed in order from the channel with the smallest channel number in one scan interval.

Use a channel of a channel number larger than that of the channel counting the number of pulses per second for the computation channel that is to calculate the number of pulses per minute.

- **Example 3: Reset When the Pulse Sum Value Exceeds a Certain Value**

Reset the sum value when the pulse sum value exceeds a specified value (reset value) and carry over the value exceeding the reset value to the sum after the reset. Count the number of resets and calculate the total sum value up to that point.

Expression

Assign expressions to the computation channels as shown below and set the constants.

Channel	Expression	Application
101	((102+P01).GE.K01)+101	Pulse sum value reset count
102	CARRY(K01):TLOG.SUM(P01)	Pulse sum value
103	K01*101+102	Total sum value

Symbol	Description
P01	Counts the number of pulses per scan interval.
K01	Constant. The reset value. The sum value is reset when this value is exceeded.

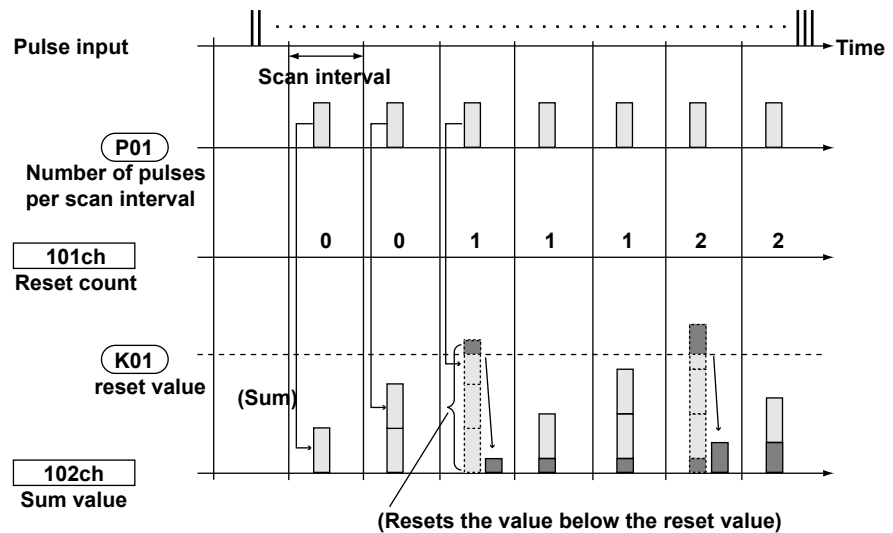

Channel 101: Reset Count

Calculates the number of times the pulse sum value is reset.

The expression “((102+P01).GE.K01)” is set to 1 when “the previous pulse sum value (102) + the current pulse count (P01)” is greater than the reset value (K01). Otherwise, the expression is set to 0. The value of channel 101 is incremented when the pulse sum value exceeds the reset value.

Channel 102: Pulse Sum Value

Calculates the pulse sum value.

Under normal conditions, the pulse sum value TLOG.SUM (P01) is calculated. When the pulse sum value is greater than or equal to the reset value (K01), the pulse sum value is set to the amount exceeding K01.

Channel 103: Total Sum Value

Multiplies the reset value (K01) by the reset count (101) and adds the pulse sum value (102) to derive the total sum value.

Note

- The computation is performed in order from the channel with the smallest channel number in one scan interval. If the channel number in the expression is greater than or equal to the channel number in which the expression is assigned, the previous computed result (previous value) is used for the channel in the expression.
- If the pulse input value of the scan interval is greater than the reset value, correct computation cannot be achieved.

3.11 Setting the Method of Detecting Over-Range Values of Linearly Scaled Measurement Channels

Setup Screen

Press **MENU** (to switch to setting mode), hold down **FUNC** for 3 s (to switch to basic setting mode), and select the **Environment** tab > **Input, Alarm**

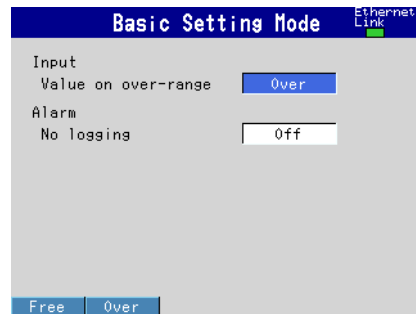

Setup Items

- **Input > Value on over-range**

Settings	Description
Free	The value is set to -over range if the value is less than -30000 and +over range if the value is greater than 30000 excluding the decimal point. The value is displayed as -Over and +Over, respectively.
Over	The value is set to -over range if the value is less than -5% of the scale and +over range if the value is greater than 105%. The value is displayed as -Over and +Over, respectively. Example: If the scale is 0.0 to 200.0, the value is set to -over range if the value is less than -10.0 of the scale and +over range if the value is greater than 210.0.

* The "Value on over-range" setting is not applied to channels that are set to log scale (/LG1 option). (See section 3.13.)

Note

For computations such as TLOG, CLOG, and report, the handling of the scale over-range value can be set in advance.

See section 9.1.

3.12 Measuring Power (/PWR1 or /PWR5 Option)

Power Monitor Function

Measure the measurement elements of electrical power. Set an expression on a computation channel, and then start the computation to begin the measurement. In addition, by using other operators, you can measure the maximum, minimum, average and electric energy.

Measurement Element	Symbol	Description
Active or regenerative power	WAT	Power values without the low-cut function applied.
Active power	WATP	
Regenerative power	WATN	
Reactive power	VAR	
Reactive power (LAG)	VARP	
Reactive power (LEAD)	VARN	
Apparent power	VA	
Active or regenerative power (low-cut)	_WAT_	Power values with the low-cut function applied. The electric energy is measured by summing these measurement elements.
Active power (low-cut)	_WATP_	
Regenerative power (low-cut)	_WATN_	
Reactive power (low-cut)	_VAR_	
Reactive power (LAG; low-cut)	_VARP_	
Reactive power (LEAD; low-cut)	_VARN_	
Apparent power (low-cut)	_VA_	
Voltage (V1)	VOL1	This is the voltage.
Voltage (V2)	VOL2	This is the voltage. This is only valid for single-phase three-wire systems.
Voltage (V3)	VOL3	This is the voltage. This is only valid for three-phase three-wire systems.
Current (I1)	CUR1	This is the current.
Current (I2)	CUR2	This is the current. This is only valid for single-phase three-wire systems.
Current (I3)	CUR3	This is the current. This is only valid for three-phase three-wire systems.
Frequency	HZ	This is the frequency.
Power factor	PF	This is the power factor.

Measuring Electric Energy

The electric energy is calculated by summing the measured values of the power measurement channels. To avoid the influence of noise in this calculation, normally use the low-cut function. On the FX, sum powers to which the low-cut function has been applied (_WAT_, _WATP_, _WATN_, _VAR_, _VARP_, _VARN_, and _VA_ in the above table) to measure the electric energy. You can set the low-cut point to any value that you want.

- **Computation Channels**

You can write expressions in computation channels to measure the electric energy. You have to set an expression—one which will be used to sum the measured power values—in a computation channel. The sum is set using the TLOG expression and the timer (see example 4 in this section). The TLOG expressions are shown in the following table.

3.12 Measuring Power (/PWR1 or /PWR5 Option)

Measurement Element	Unit	Expression
Active or regenerative energy	Wh	TLOG.SUM(_WAT_)
Active energy	Wh	TLOG.SUM(_WATP_)
Regenerative energy	-Wh	TLOG.SUM(_WATN_)
Reactive energy (LAG: +)	Varh	TLOG.SUM(_VARP_)
Reactive energy (LEAD: -)	-Varh	TLOG.SUM(_VARN_)
Apparent energy	Vah	TLOG.SUM(_VA_)

- **Report Function**

By using the report function, you can output electric energy as a power measurement channel's hourly, daily, or monthly report. In addition, on the stacked bar graph display, you can also display a list of items such as the total electric energy for a month and the electric energy for each day of the month (see example 5 in this section).

- **Update Interval of Measurement Elements**

The update interval for each of the power measurement elements is 1 second.

Setup Screen

- **Setting the Phase, Wiring System, and Input Voltage**

Press **MENU** (to switch to setting mode), hold down **FUNC** for 3 s (to switch to basic setting mode), and select the **Menu** tab > **Power**

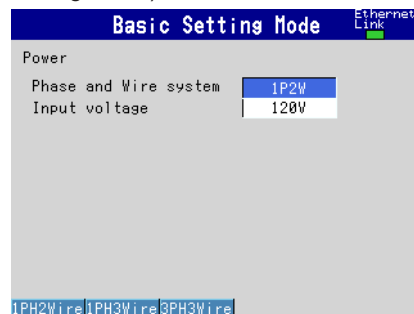

- **Setting the VT Ratio, CT Ratio, and Low-Cut Power**

Press **MENU** (to switch to setting mode), and select the **Menu** tab > **Power**.

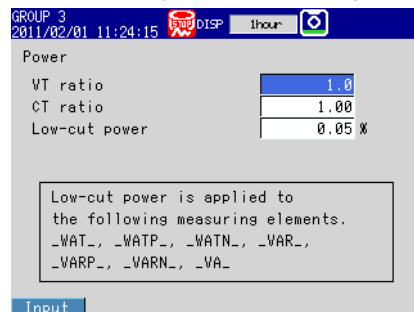

- **Setting the Power Computation**

Press **MENU** (to switch to setting mode), and select the **Menu** tab > **Math channel** > **Expression, Alarm**

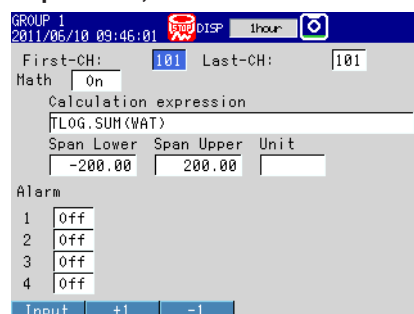

Setup Items

- **Phase and wire system**
Set the phase and wiring system by selecting from the following options: **1P2W** (single-phase two-wire system), **1P3W** (single-phase three-wire system), and **3P3W** (three-phase three-wire system).

- **Input voltage**
Set the rated input voltage to **120V** or **240V**.

- **VT Ratio, CT Ratio, and Low-Cut Power¹**
Enter values within the ranges listed below for each of the settings.

Setup Item	Setting Range	Description
VT ratio	1.0 to 6000.0	The setting is fixed to one decimal place.
CT ratio	0.05 to 999.99 1000.0 to 9999.9 10000 to 32000	The setting range varies depending on the decimal place.
Low-Cut Power ¹	0.05 to 20.00	Set this value as a percentage of the rated power. ² The setting is fixed to two decimal places. This is applied to all measurement elements to which the low-cut function has been applied (<u>_WAT_</u> , <u>_WATP_</u> , <u>_WATN_</u> , <u>_VAR_</u> , <u>_VARP_</u> , <u>_VARN_</u> , <u>_VA_</u>).

- 1 This feature sets the active power (regenerative electric power), reactive power (LEAD/LAG), or apparent power to 0 when the value becomes less than the set value of the low-cut power.
- 2 The rated power is determined by the phase, wiring system, and input voltage. (See "Power Monitor (/PWR1, /PWR5)" in section 13.5, "Options.")

Note

- If the phase and wiring system is set to **1P3W**, you can only set the input voltage to **240V**. If you select a different value, it will be automatically changed to 240V.
- When you change the phase and wiring system, the VT ratio, CT ratio, and low-cut power settings under Power on the setting menu tab will be initialized, so set these settings again.
- Set the VT ratio and CT ratio so that they meet the following condition.
Secondary rated power × 1.2 × VT ratio × CT ratio < 10 GW.

- **First-CH, Last-CH**
Select the target computation channels.

- **Math On/Off**
Select **On**.

- **Math > Calculation expression**
Use symbols to enter the equation.
For the computation channel setting procedure, see section 9.1.

Note

Voltage V2 and current I2 are only valid for single-phase three-wire systems. Voltage V3 and current I3 are only valid for three-phase three-wire systems. In other situations, you can set expressions so that they use invalid values, but if you do, an error will be returned as the measured result.

Set the following settings as necessary.

- **TLOG**
This sets the method that is used to sum the powers for measuring the electric energy. Press **MENU** (to switch to setting mode), and select the **Menu** tab > **Math channel** > **TLOG, Rolling average**.
For the computation channel setting procedure, see section 9.1.

3.12 Measuring Power (/PWR1 or /PWR5 Option)

- **Timer**

This sets the timer that is used in TLOG computations (this is used when you are resetting the electric energy after the specified time has elapsed).

Press **MENU** (to switch to setting mode), and select the **Menu** tab > **Timer, Event action** > **Timer**.

For the timer setting procedure, see section 7.1.

- **Alarm**

Press **MENU** (to switch to setting mode), and select the **Menu** tab > **Math channel** > **Expression, Alarm**.

For the computation channel setting procedure, see section 9.1.

- **Constant**

Press **MENU** (to switch to setting mode), and select the **Menu** tab > **Math channel** > **Constant**.

For the computation channel setting procedure, see section 9.1.

- **Report**

For the report creation setting procedure, see section 9.5.

Examples of power measurement expressions are given below.

- **Example 1: Active power**

Expression

Channel	Expression	Unit	Description
101	WATP	W	Active power (W)

- **Example 2: Voltage 1**

Expression

Channel	Expression	Unit	Description
101	VOL1	V	Input voltage (V) of voltage 1

- **Example 3: Current 1**

Expression

Channel	Expression	Unit	Description
101	CUR1	A	Input current (A) of current 1

- **Example 4: Active energy**

The following is an example of active energy that is calculated with a certain number of significant digits. When the active energy reaches the maximum value that can be indicated with the available number of digits, the value wraps around, like a commercial energy meter. In this example the active energy is calculated in the range of 0000.000 [kWh] to 9999.999 [kWh]. When the active energy reaches 9999.999 [kWh], it is restarted from 0000.000 [kWh].

Expression

Channel	Expression	Unit	Span	Description
101	_WATP_*K01	(User-specified)	0000.000 to 9999.999	The low-cut power (kW)
102	CARRY(K02):TLOG.SUM(101)	kWh	0000.000 to 9999.999	The active energy that wraps around at a certain value (kWh)

Constant

Constant Number	Value	Description
K01	0.001	Constant used to convert the value to kW
K02	10000	Threshold value to reset

TLOG Settings

Channel	Timer No.	Sum Scale	Reset	Description
102	(User-specified)	/h	Off	This is the sum scale. When settings are reset, this is set to Off.

Note

When you are performing an electric energy measurement that uses TLOG, use one of the following methods to ensure that a computation overflow does not occur. When a computation overflow occurs, the value is not automatically reset.

- Use the CARRY operator so that the value will be reset when it exceeds a specified value (see example 4).
- Reset the value at the specified time.

In this situation, change the settings in example 4 as shown below.

Operator: Remove the CARRY operator from channel 102.

TLOG settings: Specify the timer number, and turn reset on. Use the timer settings for the timer specified in the TLOG settings to specify when the value will be reset (see section 7.1).

3.12 Measuring Power (/PWR1 or /PWR5 Option)

- Example 5: Using the stacked bar graph display of the report function**
 Measure the active power, and create monthly and daily reports for that value. The sum of the reports will be the electric energy. You can use the stacked bar graph of the report data to display the total electric energy for a month and the electric energy for each day.

For information on the stacked bar graph display, see section 4.10.

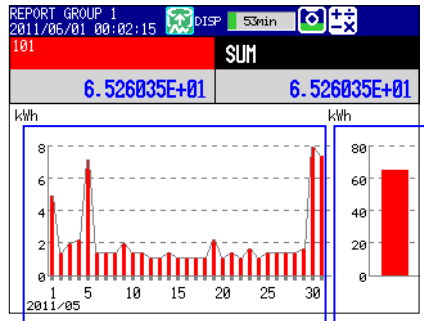

▲ Active energy for each day ▲ Active energy for one month

Expression

Channel	Expression	Unit	Description
101	_WATP_*K01	kWh	The low-cut power (kWh)*

* The unit will be displayed on the stacked bar graph, so set the unit string to "kWh."

Constant

Constant Number	Value	Description
K01	0.001	Constant used to convert the value to kW

Set the report data that will be displayed on the stacked bar graph as shown below.

For the report creation setting procedure, see section 9.5.

Basic Report Settings

Press **MENU** (to switch to setting mode), hold down **FUNC** for 3 s (to switch to basic setting mode), and select the **Menu** tab > **Report** > **Basic settings**.

Report Kind	Date	Time (Hour)
Daily and monthly reports	1	0

The daily report is created at 00:00 every day. The monthly report is created at 00:00 on the first day of every month.

Report Settings

Press **MENU** (to switch to setting mode), hold down **FUNC** for 3 s (to switch to basic setting mode), and select the **Menu** tab > **Report settings**.

Report Channel Number	On or Off	Channel	Sum Scale
R01	On	101	/h
R02 to R06*	Off		

* Report channels R01 to R06 can be shown on the stacked bar graph display. If you only want to display R01, set R02 to R06 to Off. If you are using channels R02 to R06, set the units of these channels to units that are different than the R01 channel unit.

Note

If a malfunction is detected in the power monitor function, the following will occur.

- All the power measurement elements will become error data.
- The computation icon will be displayed in red (section 1.3).
- “Detecting measurement error” in the communication status information becomes “1.”

For information on the communication status information, see section 5.2 in the Communication Interface Manual, IM 04L21B01-17EN.

3.13 Using the Log Scale to Perform Measurements (/LG1 Option)

Log Scale Display Function

You can apply a logarithmic voltage that has been converted from a physical value to the FX, and then use the FX's log scale (logarithmic scale) to display and record the physical value. The FX supports four types of input signals.

- **Logarithmic Input**

This is referred to as “**log input.**” Log input is input in which the voltage corresponds to logarithmic values of physical values.

- **Input That Is Linear on a Logarithmic Scale**

Log linear input is input in which the voltage values correspond to the logarithmic values of physical values at each decade division (for example, 1×10^2) and in which, within each decade, the voltage values correspond linearly to physical values.

- **Pseudo Log Input**

This input supports pseudo logs.

- **Nonlinear Log Input**

This input supports nonlinear logs on which calibration correction (/CC1 option) is applied. Calibration correction is performed using voltage values.

On the trend display, the FX displays waveforms with the log scale. Digital values are displayed as exponents (for example, $1.2E+03$).

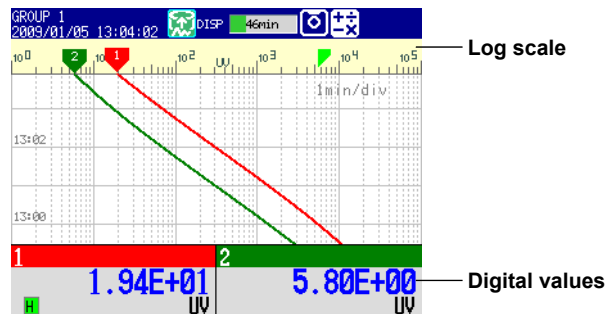

Restrictions

Partial

You cannot set the partial display on a channel that is set to log scale.

Differential Computation between Channels

If you set the reference channel of a differential computation between channels to a channel that is set to log scale, an error will be returned as the measured result of the differential computation between channels.

Calibration Correction (/CC1 option)

You cannot set calibration correction on a channel whose log scale mode is set to LogType2.

Computation Channels (/M1, /PM1, /PWR1, and /PWR5 options)

Do not include channels that are set to log scale in a computation channel expression. If you include these channels, an error will be returned as the measured result.

Report Function (/M1, /PM1, /PWR1, and /PWR5 options)

You cannot create reports for channels that are set to log scale. An error will be returned as the result of report computations on channels that are set to log scale.

Setup Screen

Input Range and Alarms

Press **MENU** (to switch to setting mode), and select the **Menu** tab > **Meas channel** > **Range, Alarm**.

Color Scale Band

Press **MENU** (to switch to setting mode), and select the **Menu** tab > **Meas channel** > **Color scale band**.

Number of Digits in the Mantissa of Digital Values, Input (LogType2 Type)

Press **MENU** (to switch to setting mode), hold down **FUNC** for 3 s (to switch to basic setting mode), and select the **Environment** tab > **LOG Input**.

Note

LogType2 in basic setting mode can be set to Linear or Pseudo.

For details on how to configure pseudo log of LogType2 and nonlinear log of LogType1, see the Setup Examples in this section.

3.13 Using the Log Scale to Perform Measurements (/LG1 Option)

Setup Items

- **Input Range**

- **First-CH, Last-CH**

Select the target channels.

- **Range > Mode**

Setting	Name
LogType1	Log input (Nonlinear log input is possible through the use of calibration correction.)
LogType2	Log linear input or pseudo log input.

- **Range > Range**

Set the range to **20mV**, **60mV**, **200mV**, **2V**, **6V**, **20V**, **50V**, or **1V**.

- **Range > Span_L and Span_U**

Set the settable range for the Range setting. You have to set these settings so that **Span_L** is less than **Span_U**.

- **Range > Scale_L, Scale_U**

Set the values by specifying the mantissas and exponents. Set the mantissas with two decimal places.

When Mode is LogType1

Set the settings so that **Scale_L** is less than **Scale_U**. Set the mantissas to values in the range of 1.00 to 9.99. Set the mantissas using three digits.

Mantissa of Scale_L	Setting Range
---------------------	---------------

1.00	1.00E-15 to 1.00E+15. However, the difference between the exponents must be at least 1. The scale width must be 15 decades or less.
------	--

	Scale_L	Scale_U	Notes
Example	1.00E+01	1.00E+02	
Examples of invalid settings	1.00E+01	2.00E+01	The difference between the exponents is less than 1.
	1.00E-01	1.00E+15	The scale width is greater than 15 decades.

A value other than 1.00	1.01E-15 to 1.00E+15. However, the difference between the exponents must be at least 2. The scale width must be 15 decades or less.
-------------------------	--

	Scale_L	Scale_U	Notes
Examples	2.00E+01	1.00E+03	
	2.00E+00	5.00E+14	
Example of invalid settings	2.00E+01	7.00E+02	The difference between the exponents is less than 2.
	2.00E-01	1.00E+15	The scale width is greater than 15 decades.
	2.00E+03	2.00E+15	The upper limit is greater than 1.00E+15.

When Mode is LogType2 (Log linear input)

You can set the settings so that **Scale_L** is less than **Scale_U** or so that **Scale_L** is greater than **Scale_U**. Set the mantissas to values in the range of 1.00 to 9.99. Set the mantissas using three digits. The mantissa that you set for **Scale_L** is automatically set as the mantissa of **Scale_U**.

Mantissa of Scale_L Setting Range

1.00 1.00E-15 to 1.00E+15. However, the difference between the exponents must be at least 1. The scale width must be 15 decades or less.

	Scale_L	Scale_U	Notes
Examples	1.00E+01	1.00E+02	
	1.00E+15	1.00E+00	
Example of invalid settings	1.00E-01	1.00E+15	The scale width is greater than 15 decades.

A value other than 1.00 1.01E-15 to 9.99E+14. However, the difference between the exponents must be at least 1. The scale width must be 14 decades or less.

	Scale_L	Scale_U	Notes
Examples	1.33E+01	1.33E+02	
	1.33E+00	1.33E+13	
	1.33E+13	1.33E+00	
Examples of invalid settings	1.33E-15	1.33E+00	The scale width is greater than 14 decades.
	1.33E+03	1.33E+15	The upper limit is greater than 9.99E+14.

The scale displayed on the FX is zoomed in until the value that is less than the lower scale limit and whose mantissa is 1.00 and the value that is greater than the upper scale limit and whose mantissa is 1.00 are displayed. See Example 4 under Scale Examples.

3.13 Using the Log Scale to Perform Measurements (/LG1 Option)

Scale Examples

Examples of scales are shown below.

Example 1

In this example, the mantissa of the scale lower limit and the mantissa of the scale upper limit are both 1.

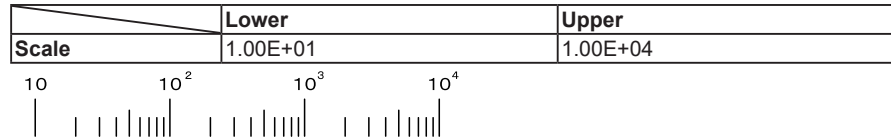

Example 2

In this example, the mode is set to LogType1, and the mantissa of the scale lower limit and the mantissa of the scale upper limit are both a value other than 1.

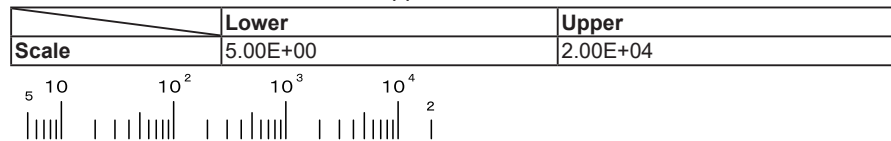

The end points of the scale are displayed using single digits if there is space to display them.

Example 3

In this example, the mode is set to LogType2, and the settings are set so that Scale_L is greater than Scale_U. The input voltage (between Span_L and Span_U) is between 1 V and 5 V.

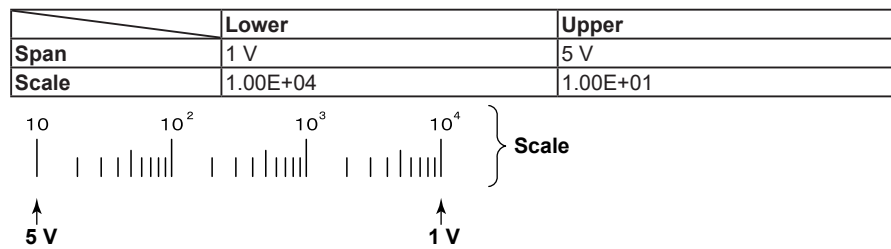

Example 4

In this example, the mode is set to LogType2, and the mantissa of the scale lower limit and the mantissa of the scale upper limit are both a value other than 1. The scale displayed on the FX is zoomed in until the value that is less than the lower scale limit and whose mantissa is 1.00 and the value that is greater than the upper scale limit and whose mantissa is 1.00 are displayed. Only the scale is zoomed in. Span_L equals Scale_L, and Span_U equals Scale_U.

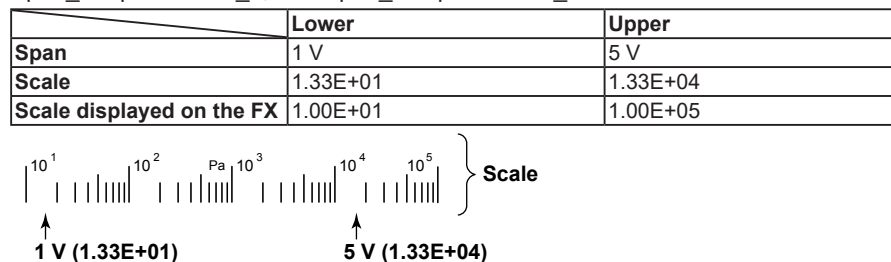

Note

Regarding Log Scale Over-range

A value less than -5% of the voltage span is a negative over-range, and a value greater than 105% of the scale is a positive over-range. They are displayed as -Over and +Over. The "Value on over-range" setting (see section 3.11) is not applied to channels that are set to log scale.

Example: If the span lower limit is set to 0 V and the span upper limit is set to 10 V, a value less than -0.5 V will result in "-Over" being displayed. A value greater than 10.5 V will result in "+Over" being displayed.

- **Range > Unit**
Set the unit (up to 6 characters, $\boxed{A}\boxed{a}\boxed{\#}\boxed{1}$).

- **Alarm**

For details on items other than those listed below, see section 3.7, “Setting Alarms on Channels.”

- **Alarm > Type**

The alarm types that you can select from are high limit alarm (H), low limit alarm (L), delay high limit alarm (T), and delay low limit alarm (t).

- **Alarm > Value**

Set the alarm value by specifying the mantissa and exponent. The range is $1.00E-16$ to $1.00E+16$. Set the mantissas to values in the range of 1.00 to 9.99.

Note

- If you set the number of mantissa display digits to 2, the second decimal place of the mantissa will be ignored. When you set the number of mantissa display digits to 2, set the second decimal place of the mantissa of the alarm value to 0.
Example: If you set the alarm value to “1.56E+12,” the actual value will be “1.5E+12.”
 - The alarm hysteresis on channels that are set to log scale is fixed to 0%. The alarm hysteresis setting (see section 3.5) is not applied to channels that are set to log scale.
-

- **Color Scale Band**

For details on items other than those listed below, see section 5.8, “Displaying Alarm Point Marks and Color Scale Band on the Scale.”

- **Display Position > Lower and Upper**

Set the display position by specifying the mantissas and exponents. The range is $1.00E-16$ to $1.00E+16$. Set the mantissas to values in the range of 1.00 to 9.99. Set the settings so that Lower is less than Upper.

- **Display digits > Digits**

You can set the number of digits in the mantissa of digital values to 2 or 3.

Example: If the number of mantissa display digits is 2, “1.2E+02.” If the number of mantissa display digits is 3, “1.23E+02.”

This setting also affects the alarm values in the alarm settings. See the Note under “Alarm” above.

- **Input > LOG**

You can select the LogType2 from **Linear** or **Pseudo**.

Linear: Sets a log linear input to LogType2 mode in the range setting.

Pseudo: Sets a pseudo log input to LogType2 mode in the range setting.

This setting applies to all channels.

3.13 Using the Log Scale to Perform Measurements (/LG1 Option)

Setup Examples

LogType2 [pseudo log] and LogType1 [nonlinear log] setup examples are shown below.

- **Setting the Pseudo Log Range (LogType2)**

This setting is for logging the pseudo log output (see the table below) of a vacuum gauge.

Pressure Reading [Pa]	Output Voltage [V]	Pressure Reading [Pa]	Output Voltage [V]
1.30×10^{-7}	0.13	5.00×10^{-4}	3.50
5.00×10^{-7}	0.50	1.00×10^{-3}	4.10
1.00×10^{-6}	1.10	5.00×10^{-3}	4.50
5.00×10^{-6}	1.50	1.00×10^{-2}	5.10
1.00×10^{-5}	2.10	5.00×10^{-2}	5.50
5.00×10^{-5}	2.50	1.00×10^{-1}	6.10
1.00×10^{-4}	3.10	9.90×10^{-1}	6.99

- 1 Press **MENU** (to switch to setting mode), hold down **FUNC** for 3 s (to switch to basic setting mode), and select the **Environment** tab > **LOG input**

Set **LogType2** under **Input** to **Pseudo**.

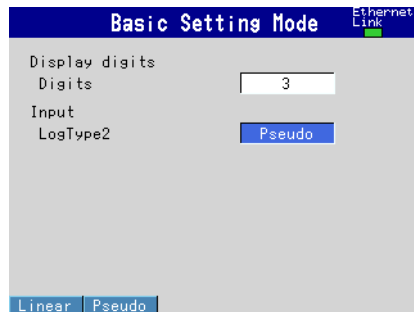

- 2 Press **MENU** (to switch to setting mode), and select the **Menu** tab > **Meas channel** > **Range, Alarm**.

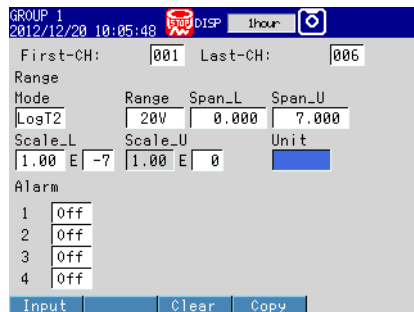

Set the range as shown below.

Mode: LogType2

Range: 20V

Span: Lower 0.000, Upper 7.000

Scale: Lower 1.00E-7, Upper 1.00E0

Display Example

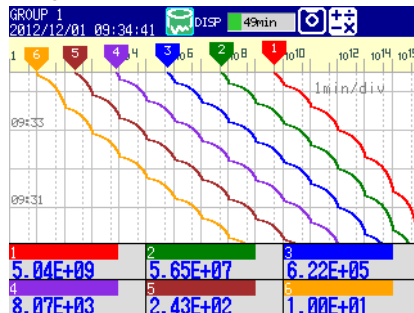

Note

- Set the mantissa to 1.00.
- The output voltage for pressure reading whose mantissa is 1.00 has a certain deviation. For example, if the pressure reading is 1.00E-5, the output voltage is 2.00 to 2.10 V. In this situation, set the range to the minimum value (2.00 V).

• **Setting the Nonlinear Log Input (LogType1)**

In this example, pressure is measured by applying calibration correction to linearly approximate the nonlinear output of a vacuum gauge.

Calculating linearizer Input and linearizer output

The following figure is an example of a nonlinear output of a vacuum gauge. The 10 red dots in the figure are the set points for the linearizer approximation. Their values are shown under ① and ② in the table below. Keep the number of set points to no more than 16.

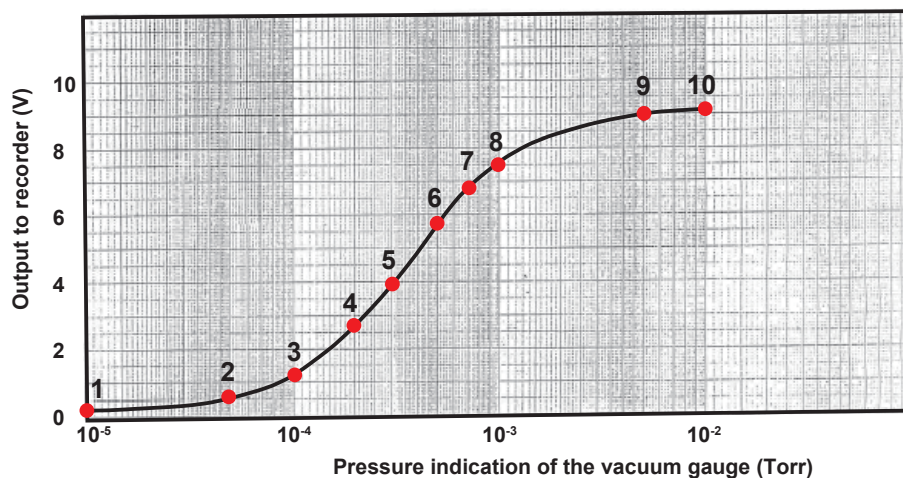

No.	① Pressure indication [Torr]	② Output to recorder [V]
1	1.00E-05	0.2
2	5.00E-05	0.55
3	1.00E-04	1.25
4	2.00E-04	2.7
5	3.00E-04	3.95
6	5.00E-04	5.7
7	7.00E-04	6.75
8	1.00E-03	7.5
9	5.00E-03	8.8
10	1.00E-02	9.1

Calculate the output (④, linearizer output) that correspond to the recorder input (②, linearizer input) in the following manner.

③: Take a log of the pressure indication values (①).

④: Linearly scale the value of each row of ③ using the ② span. The calculation formula is shown below.

$$\begin{aligned}
 \text{④} &= \frac{(\text{③} - (\text{minimum of ③}))}{(\text{maximum of ③} - \text{minimum of ③})} \times (\text{maximum of ②} - \text{minimum of ②}) + \text{minimum of ②} \\
 &= \frac{(\text{③} - (-5))}{((-2) - (-5))} \times (9.1 - 0.2) + 0.2 = \frac{\text{③} + 5}{3} \times 8.9 + 0.2
 \end{aligned}$$

3.13 Using the Log Scale to Perform Measurements (/LG1 Option)

The combination of ② and ④ is the set point.

③	④	Set point	②	④
log(①)	Linearly scale ③ using ②.		Linearizer input [V]	Linearizer output [V]
-5	0.2	1	0.200	0.200
-4.301029996	2.273611013	2	0.550	2.274
-4	3.166666667	3	1.250	3.167
-3.698970004	4.05972232	4	2.700	4.060
-3.522878745	4.582126389	5	3.950	4.582
-3.301029996	5.24027768	6	5.700	5.240
-3.15490196	5.673790852	7	6.750	5.674
-3	6.133333333	8	7.500	6.133
-2.301029996	8.206944346	9	8.800	8.207
-2	9.1	10	9.100	9.100

Setting the Channels to Use

Set the channels that you want to use as follows.

1. Setting the Range

Press **MENU** (to switch to setting mode), and select the **Menu** tab > **Meas channel** > **Range, Alarm**.

Item	Description	Explanation
Mode	LogType1	It is an input in which voltages correspond to logarithmic values of physical values.
Range	20V	Range that can cover the output to recorder (②)
Span	0.200 to 9.100	Minimum to the maximum of the output to recorder (②)
Scale	1.00E-5 to 1.00E-2	Minimum to the maximum of the pressure indication (①) of the vacuum gauge
Unit	Torr	Unit of the pressure indication (①) of the vacuum gauge

2. Configuring calibration correction

Press **MENU** (to switch to setting mode), and select the **Menu** tab > **Meas channel** > **Calibration correction**.

Item	Description	Explanation
Number of set points	10	The number of rows of ② and ④. If the number exceeds 16, decimate to no more than 16 while maintaining appropriate approximation.
MES val	(Value)	Value of ②
True val	(Value)	Value of ④

Note

For details on calibration correction (/CC1 option), see section 3.9.

4.1 Operations in Operation Mode

Switching the Screen with the DISP/ENTER Key and Arrow Keys

Press **DISP/ENTER** and **arrow keys** to show the display selection menu and sub menu to switch the display. The flow of operation is indicated below.

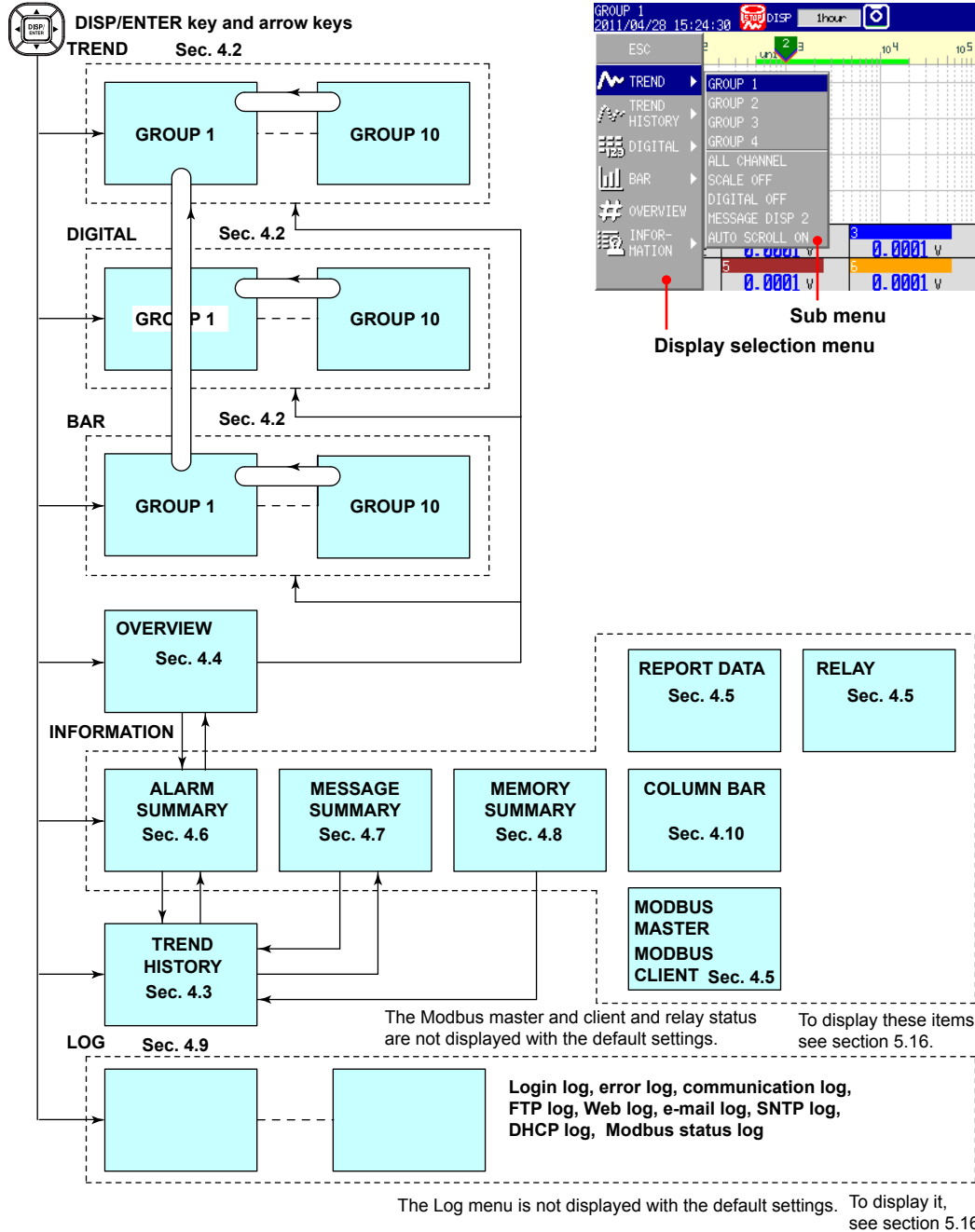

Operations Using Other Keys

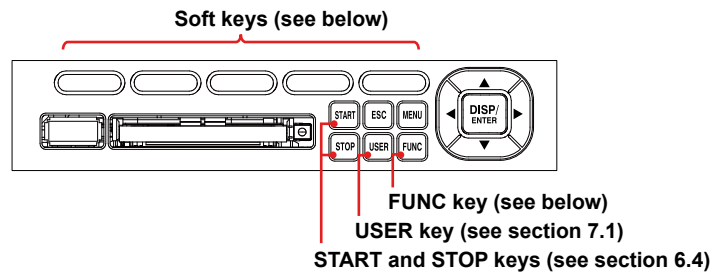

Operation Using the FUNC Key

Press **FUNC** to display the Function menu at the bottom of the screen. Press the **Next** soft key to switch the menu. Press the desired soft key.

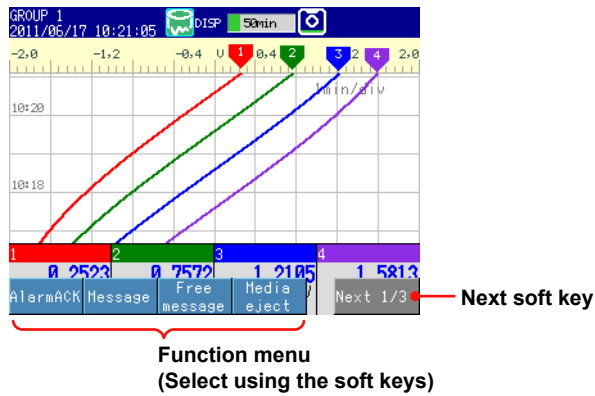

Menu Item	Refer to
Alarm ACK	Section 3.8
Message	Section 5.4
Free message	Section 5.4
Media eject	Sections 6.4 and 2.11
Snap shot	Section 6.6
Manual sample	Section 6.5
Trigger	Section 6.4
Save display	Section 6.4
Save event	Section 6.4
Save stop	Section 4.8
Math start/stop	Section 9.4
Math reset	Section 9.4
Math ACK	Section 9.4
Timer reset	Section 7.1
Keylock	Section 8.1
Logout	Section 8.3
Password change	Section 8.3
Normal speed/Second speed	Section 5.3
Batch	Section 6.3
Text field	Section 6.3
Standard display	Section 5.14
System info	Section 2.5
Network info	Section 2.5
SNTP	IM 04L21B01-17EN
E-Mail start/stop	IM 04L21B01-17EN
E-Mail test	IM 04L21B01-17EN
FTP test	IM 04L21B01-17EN

Customizing the Menus

You can change the contents of the display selection menu, which appears when you press the **DISP/ENTER** key, and the Function menu, which appears when you press the **FUNC** key.

See section 5.16.

4.2 Displaying the Measured Data as Waveforms, Values, or Bar Graphs

This section explains how to use the trend, digital, and bar graph displays. For a description of the function, see section 1.3.

Procedure

- **Showing the Display**
 1. Press **DISP/ENTER** to show the display selection menu.
 2. Press the **arrow keys** to select **TREND**, **DIGITAL**, or **BAR**, and press **DISP/ENTER**.
The selected display appears.
- **Changing the Displayed Contents**
 1. Press **DISP/ENTER** to show the display selection menu.
 2. Press the **right arrow key** to display the sub menu.
 3. Press the **up and down arrow keys** to select the sub menu item.

Trend display sub menu

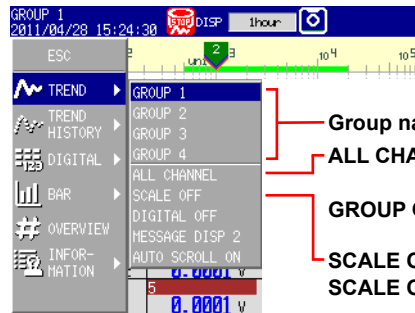

- Group name:** Displays the group
 - ALL CHANNEL:** Displays the waveforms of all channels
 - GROUP CHANNEL:** Displays the waveforms of the channels registered to groups
 - SCALE ON:** Displays the scale
 - SCALE OFF:** Clears the scale
 - DIGITAL OFF:** Clears the numeric display section
 - DIGITAL ON:** Displays the numeric display section
 - MESSAGE DISP1:** Displays the messages using display method 1
 - MESSAGE DISP2:** Displays the messages using display method 2
 - TREND SPACE ON:** Inserts a space at the right edge (horizontal display) or the top edge (vertical display) in the waveform display area
 - TREND SPACE OFF:** Does not insert a space
- (Not displayed with the default settings. To display these items, see section 5.16.)
- AUTO SCROLL ON:** Automatically switches the displayed groups
 - AUTO SCROLL OFF:** Does not automatically switch the displayed groups

4.2 Displaying the Measured Data as Waveforms, Values, or Bar Graphs

Digital display sub menu

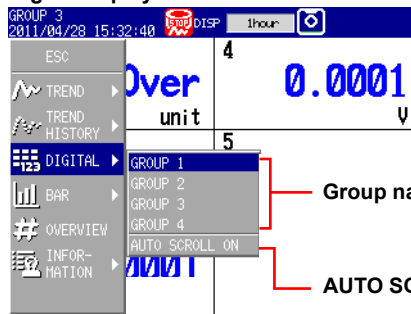

Group name: Displays the group

AUTO SCROLL ON: Automatically switches the displayed groups

AUTO SCROLL OFF: Does not automatically switch the displayed groups

Bar graph display submenu

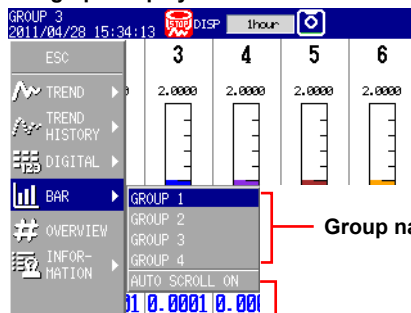

Group name: Displays the group

AUTO SCROLL ON: Automatically switches the displayed groups

AUTO SCROLL OFF: Does not automatically switch the displayed groups

4. Press **DISP/ENTER** to change the displayed contents.

To close the menu without changing the displayed contents, press the **ESC** key.

- **Starting the Waveform Display of the Trend Display/Stopping the Waveform Updating**

Press **START** to start the waveform display of the trend display. Press **STOP** to stop the waveform updating.

- **Writing Messages**

See section 5.4.

- **Switching the Displayed Group Using Arrow Keys**

Press the **right arrow key** to switch the displayed group in ascending order. Press the **left arrow key** to switch the displayed group in reverse.

- **Switching the Trend, Digital, and Bar Graph Displays Using the Arrow Keys**

Press the **down arrow key** while showing the trend, digital, or bar graph display to switch the display in the order trend, digital, bar graph, trend, and so on. Press the **up arrow key** to switch the display in reverse order.

Explanation

- ALL CHANNEL/GROUP CHANNEL on the Trend Display**
 On the group display, the channels that are assigned to the group are displayed. In all channel display, the waveforms of all channels that are configured to record data are displayed on the current group display. The waveforms of channels that are not assigned to the group are displayed in the waveform display area, but the scales, current value marks, and digital values of the channels are not displayed.
- SCALE ON/OFF and DIGITAL ON/OFF on the Trend Display**
 Select whether to show or hide the scale and numeric display sections.
- AUTO SCROLL ON/OFF**
 The displayed groups can be automatically switched at a specified interval by selecting **AUTO SCROLL ON**. The display switches in ascending group order. For the procedure to set the auto scroll interval of groups, see section 5.13.
- MESSAGE DISP 1 and MESSAGE DISP 2 on the Trend Display**
 Switches the message display method.
- TAG DISPLAY ON/OFF**
 Tags are displayed with a fixed character length of 16 characters. The figure below shows an example for when six channels are being displayed.

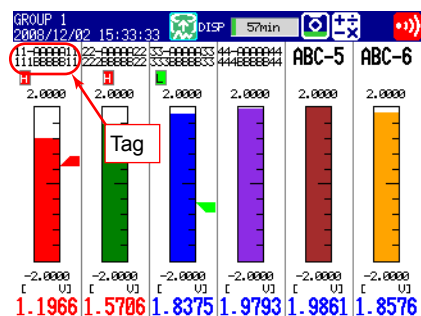
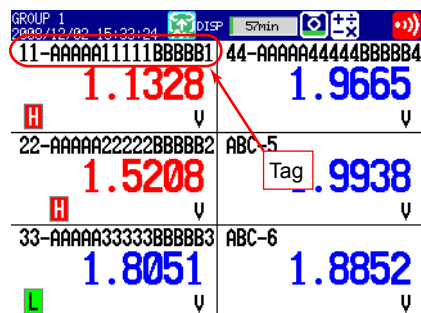
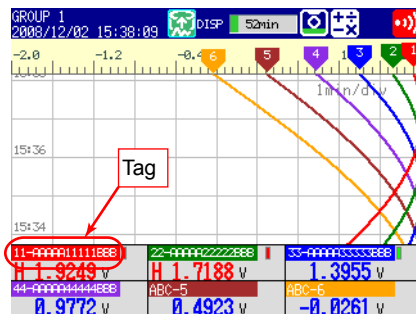

• **TREND SPACE ON/OFF**

With TREND SPACE ON

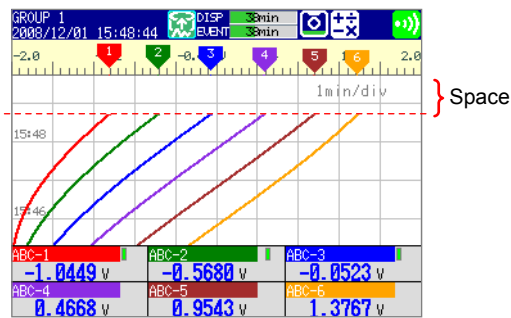

4.3 Displaying Past Measured Data (Historical Trend Display)

There are five methods to display the past measured data.

For a description of the function, see section 1.3.

Recall from the display selection menu (see this section).

Display from the alarm summary (see section 4.6).

Display from the message summary (see section 4.7).

Display from the memory summary (see section 4.8).

Show the measured data stored on an external storage medium (see section 6.8).

Procedure

• Showing the Display

Carry out the procedure below while memory sampling is in progress.

1. Press **DISP/ENTER** to show the display selection menu.
2. Press the **arrow keys** to select **TREND HISTORY**, and press **DISP/ENTER**.
The display appears.

• Changing the Displayed Contents

1. Press **DISP/ENTER** to show the display selection menu.
2. Press the **right arrow key** to display the sub menu.
3. Press the **up and down arrow keys** to select the sub menu item.

Historical trend display sub menu

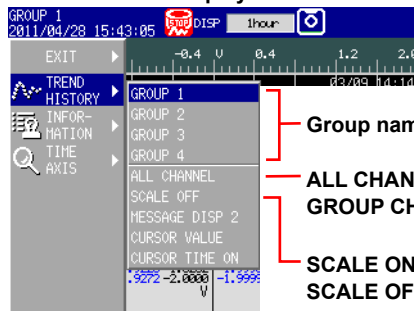

- Group name:** Displays the group
- ALL CHANNEL:** Displays the waveforms of all channels
- GROUP CHANNEL:** Displays the waveforms of the channels registered to groups
- SCALE ON:** Displays the scale
- SCALE OFF:** Clears the scale

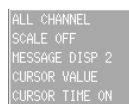

- MESSAGE DISP2:** Displays the messages using display method 2
- MESSAGE DISP1:** Displays the messages using display method 1
- CURSOR VALUE:** With display data, shows the maximum data value at the cursor position. With event data, shows the data at the cursor position.
- DIGITAL MAX/MIN:** Displays the maximum and minimum values at the cursor position and the maximum and minimum values within the displayed data in the digital value display area.
- CURSOR TIME ON:** Displays the time at the cursor position.
When the trend display direction is vertical:
Upper right
When the trend display direction is horizontal:
Lower right
- CURSOR TIME OFF:** Displays the date/time of the data at the right edge of the screen.

4.3 Displaying Past Measured Data (Historical Trend Display)

Historical trend display sub menu

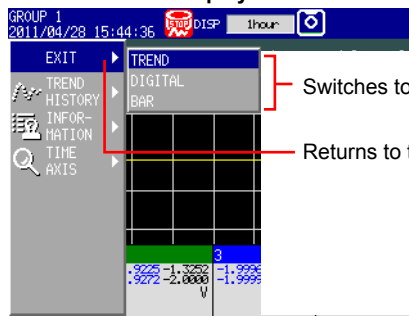

Switches to the specified display

Returns to the display that was shown before the historical trend

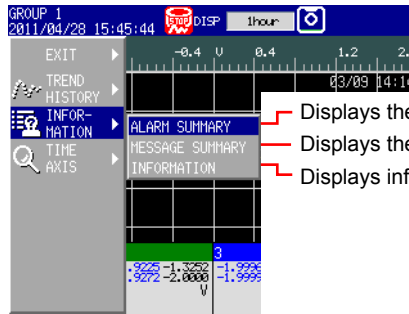

Displays the alarm summary contained in the loaded data file

Displays the message summary contained in the loaded data file

Displays information about the loaded data file

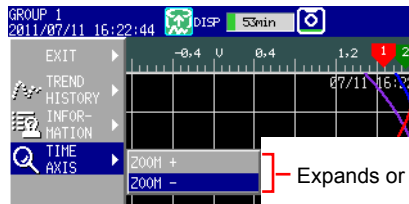

Expands or reduces the time axis

4.3 Displaying Past Measured Data (Historical Trend Display)

Sub menu when the alarm summary is being displayed

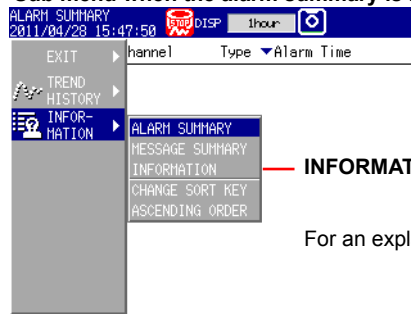

INFORMATION: Shows information about the measured data that is currently displayed

For an explanation of the other menu items, see section 4.6.

Sub menu when the message summary is being displayed

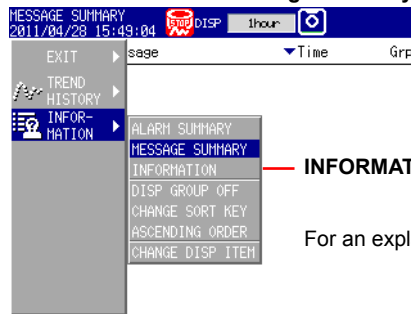

INFORMATION: Shows information about the measured data that is currently displayed

For an explanation of the other menu items, see section 4.7.

4. Press **DISP/ENTER** to change the displayed contents.
To close the menu without changing the displayed contents, press the **ESC** key.

• **Moving the Cursor and Scrolling the Waveform**

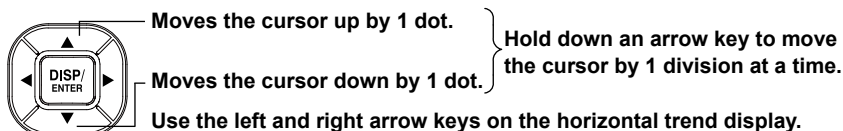
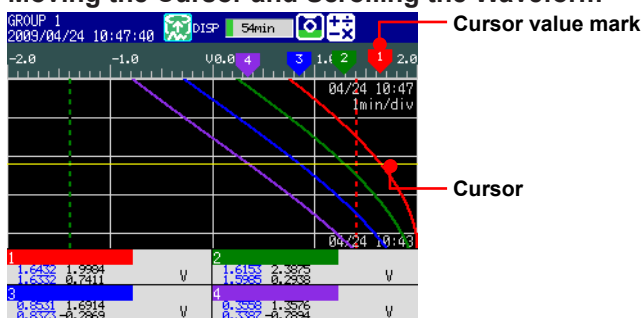

• **Displaying the Continuing Data**

Approximately one screen of data is shown on the historical trend display. The continuing data can be shown as follows:

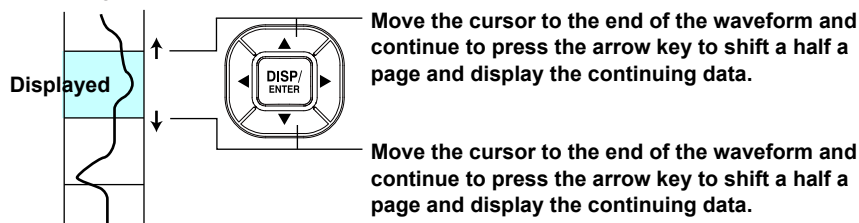

Use the left and right arrow keys on the horizontal trend display.

• **Specifying the Display Range**

Specify the display range. Items inside the parentheses are for the horizontal trend display.

* When you clear the scale (see page 4-8), the screen switching icons appear in its place.

1. Press the **right (up) arrow key**.

The waveform of the entire data range is displayed at the right (top) section of the screen.

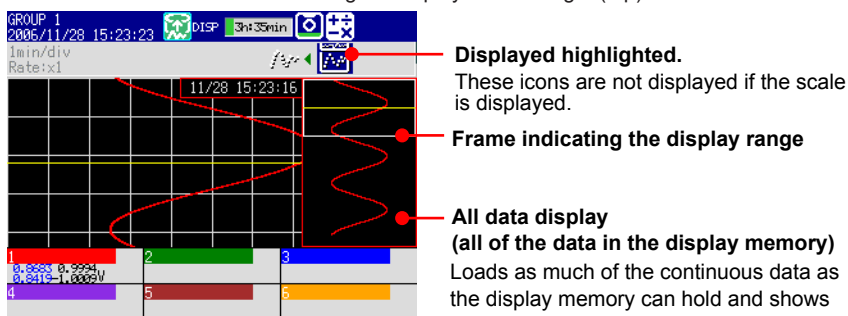

Displayed highlighted.
 These icons are not displayed if the scale is displayed.
 Frame indicating the display range
 All data display (all of the data in the display memory)
 Loads as much of the continuous data as the display memory can hold and shows the data when switching to the all data display.

2. Press the **up and down (left and right) arrow keys** to set the display position by moving the frame that indicates the display range. If you hold down one of the arrow keys, the frame that indicates the display range will move continuously in the direction of the arrow that you hold down.

3. Press the **left (down) arrow key**.

The specified range is displayed.

4.3 Displaying Past Measured Data (Historical Trend Display)

- **If the Data Does Not Fit in the All Data Display**

Specify the range to be displayed in the all data display.

Below is the procedure to display data that is older than the data displayed currently.

Items inside the parentheses are for the horizontal trend display.

1. Press the **right (up) arrow key**.

The waveform of all the data in the display memory is displayed at the right (top) of the screen. At the same time, the data area in the internal memory that can be loaded is displayed. In addition, the data position of 8 MB that is displayed in the all data display is indicated using a rectangular frame in the loadable data area.

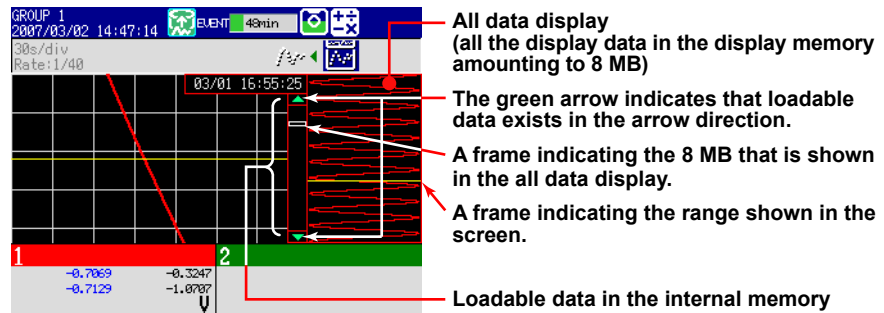

2. Press the **down (left) arrow key** to move the frame indicating the display range to the edge of the all data display. If you press the **down (left) arrow key** again, the message “Overwrite old data?” appears.

3. Select **Yes** and press **DISP/ENTER** to replace 4 MB of data in the display memory.

4. Press the **up/down (left/right) arrow key** to move the frame indicating the display range to specify the range you want to display.

5. Press the **left (down) arrow key**.

The specified range is displayed.

- **Dividing the Screen into Halves and Displaying the Current Trend and Historical Trend Simultaneously**

This operation is possible only when the historical trend of the display data is being displayed. Items inside the parentheses are for the horizontal trend display.

* This operation is not possible when the scale is displayed.

Press the **left (down) arrow key**.

The current trend is displayed in the top half (right half), and the historical trend is displayed in the bottom half (left half) of the screen.

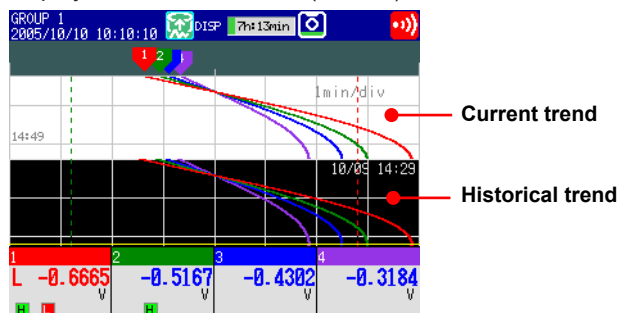

To revert to the original screen, press the **right (up) arrow key**.

- **Writing Add Messages**

For the operating procedure, see section 5.4.

Explanation

• **ALL CHANNEL/GROUP CHANNEL**

In the group display, the waveforms of the channels that are registered to the group are displayed. In the all channel display, the waveforms of all channels that have been set to be recorded are displayed on the current group display. The waveforms of channels that are not registered to the group are displayed, without any additional information, in the waveform display area.

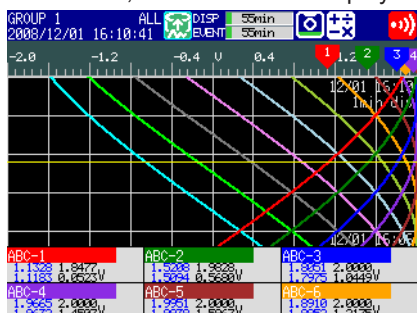

The waveforms of all channels are displayed.

• **SCALE ON/OFF**

Select whether to display the scale. The current value mark of the scale indicates the value at the cursor position.

With SCALE ON

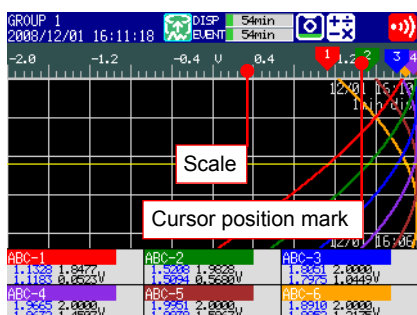

With SCALE OFF

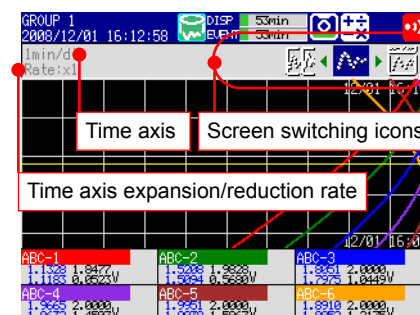

• **MESSAGE DISP 1, MESSAGE DISP 2**

Switch between message displays.

• **CURSOR VALUE/DIGITAL MAX/MIN**

Switch between numeric displays.

With DIGITAL MAX/MIN

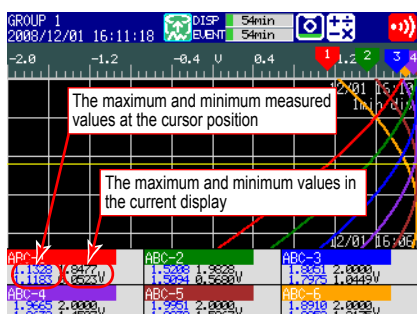

With CURSOR VALUE

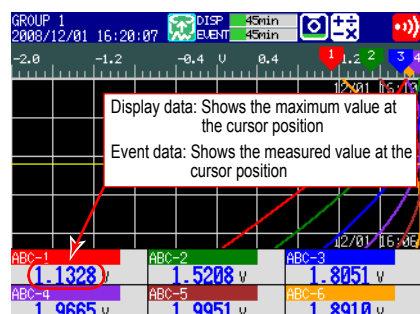

4.3 Displaying Past Measured Data (Historical Trend Display)

- **CURSORS TIME**

With CURSOR TIME ON

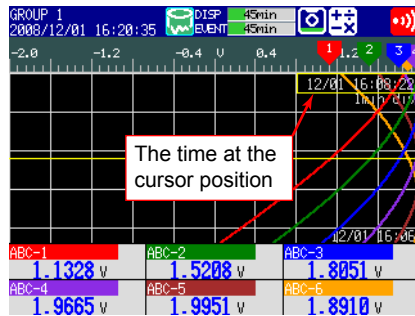

- **TIME AXIS > ZOOM+ and ZOOM-**

The time axis can be expanded or reduced around the cursor position.

- Display data: 2 times the trend display to 1/60 minimum
- Event data: Reduction only, up to 1/60 minimum

The minimum magnification and the factor by which the display can be expanded or reduced with one operation vary depending on the trend interval for the display data and on the sampling interval for the event data. To expand or reduce further, repeat the procedure.

With TIME AXIS ZOOM+

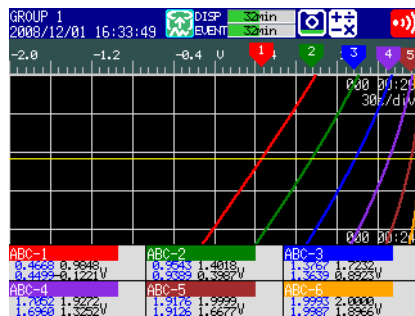

With TIME AXIS ZOOM-

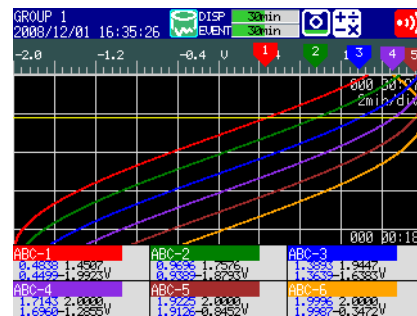

• **INFORMATION (Information on the Displayed Measured Data)**

The following information is displayed.

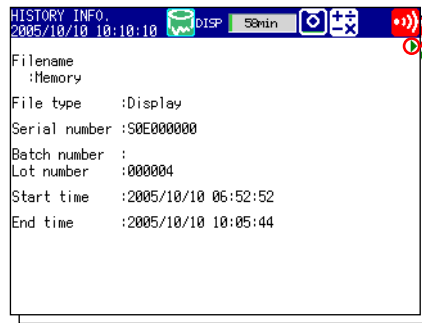

Page switch mark
Use the **left and right arrow keys** to switch the page.

Display	Description
File name	Data in the internal memory is displayed as "Memory." For a file on the external storage medium, the file name is displayed.
File type	Display corresponds to display data, and Event corresponds to event data.
Serial number	The serial number of the FX that was used.
Batch number, Lot number	Displayed when the file is created using the batch function.
Start time, End time	The start time and end time of recording.
User name	Name of the user who performed the operation. Displayed when the login function is used.
Comment	A comment (when the batch function is in use).
Text field	A text field (when the batch function is in use).

Note

When measured data on the external storage medium is displayed, the serial number corresponds to that of the FX that was used to save the data.

• **Background Color of the Historical Trend**

You can change the background color of the historical trend.

For setting procedure, see section 5.12.

4.4 Display the Statuses of All Channels on One Screen (Overview Display)

This section explains how to use the overview display.
For a description of the function, see section 1.3.

Procedure

- **Showing the Display**

1. Press **DISP/ENTER** to show the display selection menu.
2. Press the **arrow keys** to select **OVERVIEW**, and press **DISP/ENTER**.
The display appears.

- **Changing the Displayed Contents**

1. Press **DISP/ENTER** to show the display selection menu.
2. Press the **right arrow key** to display the sub menu.
3. Press the **up and down arrow keys** to select the sub menu item.

Overview display sub menu

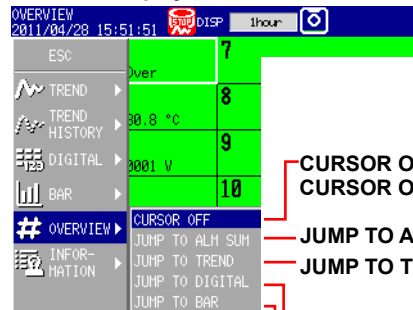

- CURSOR OFF:** Clears the cursor
- CURSOR ON:** Displays the cursor
- JUMP TO ALM SUM:** Switches to the alarm summary
- JUMP TO TREND:** Switches to the trend display of the smallest group number that includes the channel selected with the cursor.
- JUMP TO DIGITAL:** Switches to the digital display of the smallest group number that includes the channel selected with the cursor.
- JUMP TO BAR:** Switches to the bar graph display of the smallest group number that includes the channel selected with the cursor.

(Not displayed with the default settings. To display these items, see section 5.16.)

4. Press **DISP/ENTER** to change the displayed contents.
To close the menu without changing the displayed contents, press the **ESC** key.

- **Showing the Trend, Digital, Bar Graph Display Containing the Specified Channel**

1. Press the **arrow keys** to move the cursor, and select a channel.

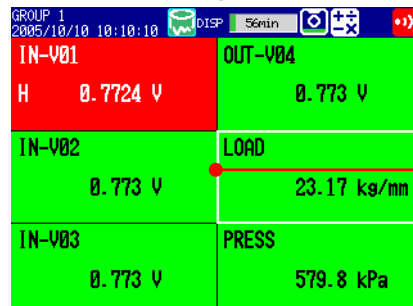

Cursor (white Frame)

2. Switch to the trend, digital, or bar graph display according to the procedure described in "Changing the Displayed Contents."

4.5 Displaying Various Information

This section explains how to display reports (/M1, /PM1, /PWR1, and /PWR5 options) and how to use the status displays.

For a description of the function, see section 1.3.

Procedure

• Showing the Display

1. Press **DISP/ENTER** to show the display selection menu.
2. Press the **up and down arrow keys** to select **INFORMATION**.
3. Press the **right arrow key** to display the sub menu.
4. Press the **up and down arrow keys** to select the sub menu item.
To close the menu without changing the displayed contents, press the **ESC** key.

Information display sub menu

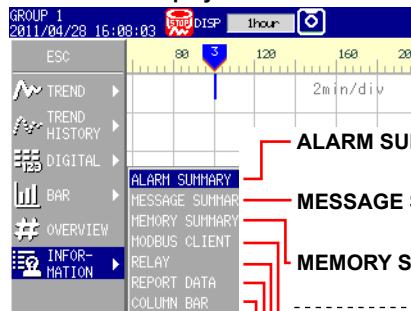

ALARM SUMMARY: Displays an alarm summary
See section 4.6.

MESSAGE SUMMARY: Displays a message summary
See section 4.7.

MEMORY SUMMARY: Displays a memory summary
See section 4.8.

MODBUS CLIENT: Displays the Modbus client status

MODBUS MASTER: Displays the Modbus master status

RELAY: Displays the relay status

(Not displayed with the default settings. To display, see section 5.16.)

REPORT DATA: Displays report data

COLUMN BAR: Displays report data using stacked bar graphs

5. Press **DISP/ENTER**.
The display appears.

• Displaying the Report

• Switching the Displayed Report Data

The **Index** item on the report display shows “the number of the report data being displayed/the number of report data saved in the internal memory.” The largest report data number corresponds to the most recent report data. Start is when the report is started and Timeup is when the report is created.

Number of the report data being displayed

Number of report data saved to the internal memory

Ch	Unit	Sts	Ave	Max	Min	Sum
001	V	—	0.8496	0.9228	0.6923	1.572792E+02
002	V	—	0.6506	0.7066	0.5306	1.204353E+02
003	V	—	0.5377	0.5841	0.4385	9.954263E+01
004	V	—	0.4909	0.4335	0.3269	7.422102E+01

4.5 Displaying Various Information

Carry out the procedure below to switch the displayed report data.

- Up arrow key:** Report data being displayed + 1.
- Down arrow key:** Report data being displayed - 1.
- Left arrow key:** Report data being displayed + 10.
- Right arrow key:** Report data being displayed - 10.

Note

The display is not updated even if a new report is created while displaying the report data. Perform either of the operations below to display the most recent report data.

- Hold down the **left arrow key** until the latest report data is displayed.
- Press **DISP/ENTER** and display the report data again from the display selection menu.

Switching the Report Channels

Up to 12 report channels can be shown on one screen. If there are more than 12 report channels, you can switch the displayed report channels.

1. Press **DISP/ENTER** to show the display selection menu.
2. Press the **right arrow key** to display the sub menu.
3. Press the **up and down arrow keys** to select **CHANGE REPORT CH.**
4. Press **DISP/ENTER**.

The displayed report channels are switched.

Relay Status Display

Lists the statuses of the alarm output relays and internal switches. You cannot change the settings on this display.

Relay	Status	Relay	Status	Relay	Status
I01	Red	S01	Green	S16	Green
I02	Green	S02	Green	S17	Green
I03	Red	S03	Green	S18	Green
I04	Red	S04	Green	S19	Green
I05	Green	S05	Green	S20	Green
I06	Green	S06	Green	S21	Green
		S07	Green	S22	Green
		S08	Green	S23	Green
		S09	Green	S24	Green
		S10	Green	S25	Green
		S11	Green	S26	Green
		S12	Green	S27	Green
		S13	Green	S28	Green
		S14	Green	S29	Green
		S15	Green	S30	Green

Red: ON
Green: OFF

Modbus Status Display

Lists the statuses of the Modbus client or Modbus master commands.

For the operating procedure, see the *Communication Interface User's Manual*, IM 04L21B01-17EN.

No.	Status	Comm. Data	First	Last	Server name	Registers
1	R ● Good	C01 - C08			modbus.dawstati	30001
2	W ○ None	1 - 4			192.168.1.80	40001
3	W ○ None	101 - 105			192.168.1.80	40010

Communication conditions

Communication destination

FX channels

Status

Command

4.6 Using the Alarm Summary

This section explains how to use the alarm summary.

For a description of the function, see section 1.3.

For details on how to display the summary, see section 4.5.

Procedure

• Changing the Displayed Contents

1. Press **DISP/ENTER** to show the display selection menu.
2. Press the **right arrow key** to display the sub menu.
3. Press the **up and down arrow keys** to select the sub menu item.

Sort symbol ▲ Ascending sort
▼ Descending sort

Display name: Switches to the specified display

TO HISTORY (DISP): Switches to the display data historical trend display

TO HISTORY (EV): Switches to the event data historical trend display

TO OVERVIEW: Switches to the overview display

CHANGE SORT KEY: Sorts alarm information by channel or alarm time

ASCENDING ORDER: Sorts in ascending order

DESCENDING ORDER: Sorts in descending order

4. Press **DISP/ENTER** to change the displayed contents.
To close the menu without changing the displayed contents, press the **ESC** key.

• Moving the Cursor (→) and Scrolling the Alarms

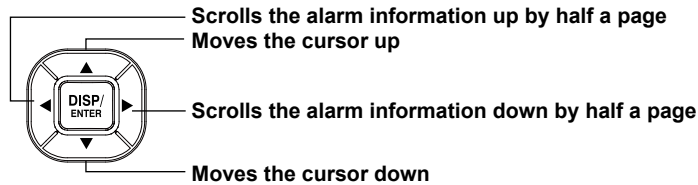

• Recalling the Historical Trend Display at the Point When the Alarm Occurred

1. Select an alarm with the cursor.
2. Display the historical trend according to the procedure described in “Changing the Displayed Contents.”

Explanation

• CHANGE SORT KEY, ASCENDING ORDER, and DESCENDING ORDER

The alarms are sorted in ascending or descending order by the following keys. The sort symbol is displayed next the sort item (see the figure above).

- Channel number: Sorts the alarms by channel number even if tags are being used. Alarms in a channel are sorted by the alarm level number.
- Time of alarm occurrence/release

4.7 Using the Message Summary

This section explains how to use the message summary.
 For a description of the function, see section 1.3.
 For details on how to display the summary, see section 4.5.

Procedure

- **Changing the Displayed Contents**

1. Press **DISP/ENTER** to show the display selection menu.
2. Press the **right arrow key** to display the sub menu.
3. Press the **up and down arrow keys** to select the sub menu item.

The screenshot shows a terminal window with the following menu structure:

```

MESSAGE SUMMARY
2011/07/15 09:38:14
ESC  sage  Time  Grp
TREND  >  11/07/15 09:32 1
TREND  >  11/07/15 09:32 1
HISTORY >
DIGITAL >
BAR >
OVERVIEW #
INFORMATION >
ALARM SUMMARY
MESSAGE SUMMARY
MEMORY SUMMARY
MODBUS CLIENT
RELAY
REPORT DATA
COLUMN BAR
TO HISTORY (DISP)
TO HISTORY (EV)
DISP GROUP OFF
CHANGE SORT KEY
ASCENDING ORDER
CHANGE DISP ITEM
  
```

Sort symbol

- ▲ Ascending sort
- ▼ Descending sort

Display name: Switches to the specified display

TO HISTORY (DISP): Switches to the display data historical trend display

TO HISTORY (EV): Switches to the event data historical trend display

DISP GROUP OFF: Displays the second of the time when the messages were written

DISP GROUP ON: Displays the groups to which the messages were written

CHANGE SORT KEY: Sorts messages by message number, time, group, or user name

ASCENDING ORDER: Sorts in ascending order

DESCENDING ORDER: Sorts in descending order

CHANGE DISP ITEM: Switches between displaying message times and groups and displaying the message user names

4. Press **DISP/ENTER** to change the displayed contents.
 To close the menu without changing the displayed contents, press the **ESC** key.

- **Moving the Cursor (➡) and Scrolling the Messages**

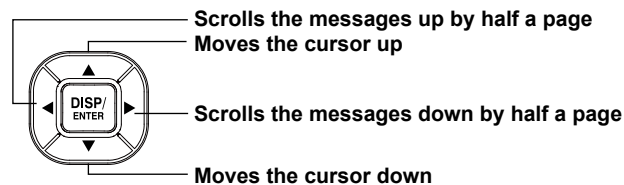

- **Recalling the Historical Trend Display at the Point When the Message Was Written**

1. Select a message with the cursor.
2. Display the historical trend according to the procedure described in "Changing the Displayed Contents."

Explanation

- **CHANGE DISP ITEM**
Switches between the following two message display methods.
 - Message, time, and group, or the second of the date and time when the message was written
 - Message, user name

- **CHANGE SORT KEY, ASCENDING ORDER, and DESCENDING ORDER**
The messages are sorted in ascending or descending order by the respective key. The sort symbol is displayed next to the sort item (see the figure on the previous page).

- **DISP GROUP OFF/ON**
You can select what is displayed on the right of the screen: the groups that the messages were written to or the second of the time when the messages were written.

4.8 Using the Memory Summary

This section explains how to use the memory summary.
 For a description of the function, see section 1.3.
 For details on how to display the summary, see section 4.5.

Procedure

- **Changing the Displayed Contents**

1. Press **DISP/ENTER** to show the display selection menu.
2. Press the **right arrow key** to display the sub menu.
3. Press the **up and down arrow keys** to select the sub menu item.

The displayed data type is indicated with a green mark.

Display name:	Switches to the specified display
TO HISTORY:	Switches to the historical trend display
DATA SAVE MODE:	Switches to data save mode
SELECT SAVE:	Saves the selected file
M.SAMPLE SAVE:	Saves all manually sampled data
REPORT SAVE:	Saves all report data
(Not displayed with the default settings. To display these items, see section 5.16.)	
ALL SAVE:	Saves all data
CHANGE DATA KIND:	Switches between display data and event data
FILENAME DISPLAY:	Displays the file name
TIME DISPLAY:	Displays the times of the first and last items of data in the file

4. Press **DISP/ENTER** to change the displayed contents.
 To close the menu without changing the displayed contents, press the **ESC** key.

- **Moving the Cursor (↔) and Scrolling the Memory Information**

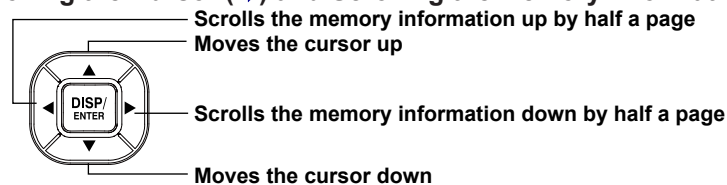

- **Displaying the Historical Trend for the Data Specified by Memory Summary**

1. Select the data with the cursor.
2. Display the historical trend according to the procedure described in “Changing the Displayed Contents.”

- **Saving the Data**

Save the data in the internal memory to the CF card/SD card or the USB flash memory (/USB1 option).

For a description of the function, see section 1.4.

1. Press **DISP/ENTER** to show the display selection menu.
2. Press the **right arrow** key to display the sub menu.
3. Select **DATA SAVE MODE** with the **up and down arrow keys**.
4. Press **DISP/ENTER**.

The display switches to DATA SAVE MODE (a string indicating this mode is displayed in the upper left of the screen).

5. To save a specified file, select it with the cursor. This operation is not necessary in other cases.

SAMPLE DATA		DISPLAY DATA(DAD)		EVENT DATA(DAE)	
Start Time	End Time	Data	Factor		
12/02 15:12:24	12/02 15:13:16	27		Sample Line	
12/02 15:12:14	12/02 15:12:16	2		Stop	
12/02 15:03:42	12/02 15:12:06	253		Stop	
12/02 15:02:26	12/02 15:03:10	22		Power Off	
12/02 15:01:48	12/02 15:01:54	4		Power Off	

Cursor
(move with the arrow keys)

6. Press **DISP/ENTER** to show the display selection menu.

EXIT		DISPLAY DATA(DAD)		EVENT DATA(DAE)	
End Time	Data	Factor			
12/02 15:13:22	30		Sample Line		
12/02 15:12:16	2		Stop		
12/02 15:12:06	253		Stop		
12/02 15:03:10	22		Power Off		
12/02 15:01:54	4		Power Off		

7. Use the **up and down arrow keys** to select **SELECT SAVE, ALL SAVE, M. SAMPLE SAVE, or REPORT SAVE**.

8. Press **DISP/ENTER**.

* If you are using a CF card/SD card and a USB flash memory (/USB1 option), the message "Which media do you want save to?" appears. Select the destination medium using the **arrow keys**, and press **DISP/ENTER**.

The measured data is saved.

Note

To abort the data saving operation in progress, carry out the procedure below.

Press **FUNC** and press the **Save Stop** soft key.

4.8 Using the Memory Summary

Progress Display When Saving All Data of the Internal Memory

If you carry out All Save* on the memory summary screen, a pop-up window appears showing the progress of the save operation.

- * Function for saving all data in the internal memory to a CF card/SD card or USB flash memory.

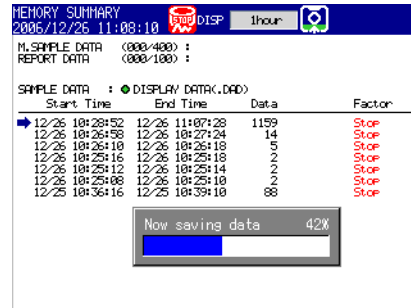

Note

- The pop-up window appears only when the memory summary display is showing.
- If you press the ESC key, the pop-up window clears temporarily and reappears approximately 10 seconds later.
- The time estimate for saving all data is indicated in the table below (when the memory is full of data). It may take longer depending on the operating conditions of the FX.

Save Destination	Time to Save All Data (Estimate)
CF card/SD card	Approximately 20 minutes
USB flash memory	Approximately 40 minutes

- To abort the data saving operation in progress, carry out the procedure below. Press **FUNC** and press the **Save Stop** soft key.

Explanation

• Save directory

- When you have switched to data save mode from the memory summary display or the operation selection display (see page 2-13) when a USB device is connected to the FX, if you then try to continue saving the same file, a message asking you to confirm that you want to overwrite the file is displayed.
- In the following situations, the FX will create a new directory to store the data in each time you save data. Even if you save the same file, no message asking you to confirm that you want to overwrite the file will be displayed.
 - If you exit data save mode and then switch back to data save mode.
 - If you select the save format from the sub menu without switching to data save mode.
- The directory name structure is: Specified string_YYMMDD_HHMMSS (the values of YY to SS are the date and time of operation).

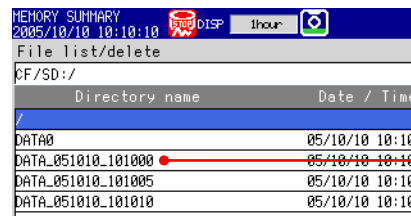

- Display data or event data that is in the process of adding data cannot be saved.
- The save operation explained here merely copies the data in the internal memory. It does not save the unsaved data in the internal memory (see page 1-27).
- Data saving is aborted when there is insufficient free space on the storage medium. Use a storage medium with sufficient free space when saving data.

4.9 Displaying a List of Operation Logs

Displays the following operation logs.

Login log, error log, communication log, FTP log, Web log, e-mail log, SNTP log, DHCP log, and Modbus status log

Procedure

• Displaying the Log

1. Press **DISP/ENTER** to show the display selection menu.
2. Press the **up and down arrow keys** to select **LOG**.
 - * LOG is not displayed with the default settings.
To show **LOG** on the menu, see section 5.16.
3. Press the **right arrow key** to display the sub menu.
4. Press the **up and down arrow keys** to select the sub menu item.
To close the menu without changing the displayed contents, press the **ESC** key.
5. Press **DISP/ENTER**.
The display appears.

Explanation

• Login Log

The log number of the last line and the total number of logs

Time	Action	Factor	Username
10/10 06:00:00	Login	KEY	Admin1
10/10 06:00:01	PowerOn	SYS	
10/09 11:28:29	PowerOff	SYS	
10/09 09:09:09	NewTime	KEY	
01/01 00:00:01	TimeChg	KEY	

User name

Operation method (see the table below)

Operation (see the table below)

Date/time

Action	Description
Login	Login
Logout	Logout
NewTime	Time change while memory is stopped
TimeChg	Time change through key operation
PowerOff	Power OFF (power failure occurred)
PowerOn	Power ON (recovered from a power failure)
TrevStart	Start the operation of gradually adjusting the time
TRevEnd	End the operation of gradually adjusting the time
SNTPtimset	Time change by SNTP
TimeDST	Switch the daylight savings time

4.9 Displaying a List of Operation Logs

Factor	Description
KEY	Key operation
COM	Operations via communication
REM	Operation through the remote control function
ACT	Operation through event action
SYS	Operation by the system

• Error Log



(012/013) Time	No.	Message
2005/10/09 15:11:07	232	There is no available da..
2005/10/09 15:10:59	120	Measured value is incorr..
2005/10/09 15:07:15	151	This action is not possi..
2005/10/09 15:05:33	210	Media has not been inser..
2005/10/09 15:04:03	294	No time correction becau..

Error message*

Error code*

Date/time

* See section 10.1, "A List of Messages."

• Communication Log

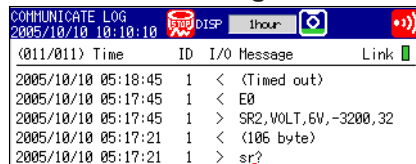

(011/011) Time	ID	I/O	Message	Link
2005/10/10 05:18:45	1	<	(Timed out)	
2005/10/10 05:17:45	1	<	E0	
2005/10/10 05:17:45	1	>	SR2,VOLT,6V,-3200,32	
2005/10/10 05:17:21	1	<	(106 byte)	
2005/10/10 05:17:21	1	>	sr?	

Message*

Input/output symbol (>: input, <: output)

User ID number (0: serial, 1 to 3: Ethernet)

Date/time

* See the *Communication Interface User's Manual*, IM 04L21B01-17EN.

• FTP Log

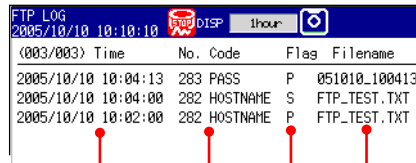

(003/003) Time	No.	Code	Flag	Filename
2005/10/10 10:04:13	283	PASS	P	051010_100413
2005/10/10 10:04:00	282	HOSTNAME	S	FTP_TEST.TXT
2005/10/10 10:02:00	282	HOSTNAME	P	FTP_TEST.TXT

File Name

FTP connection destination
(P: primary, S: secondary)

Error message (detail code)*

Date/time

* See section 10.1, "A List of Messages."

• **Web Log**

Time	Request	No.	Parameter
10/10 10:10:10	Message		STOP
10/10 10:10:00	Message		BATTERY
10/10 10:08:50	Screen		TREND GROUP=1
10/10 10:07:40	Screen		HISTORY GROUP=1
10/10 10:07:30	Message		HIGH VOLTAGE
10/10 00:37:50	Message	155	HIGH VOLTAGE

- Operation (see the table below)
- Error code*
- Requested operation (see the table below)
- Date/time

* See section 10.1, "A List of Messages."

Request	Description
Screen	Screen switch
Key	Key operation
Message	Message assignment/write

Parameter	Description
TREND	Trend display
DIGIT	Digital display
BAR	Bar graph display
HIST	Historical trend display
OV	Overview display
DISP	DISP/ENTER key
UP	Up arrow key
DOWN	Down arrow key
LEFT	Left arrow key
RIGHT	Right arrow key
Messages	Character strings that have been written

• **E-mail Log**

Time	Type	No.	Recipient / Error
10/09 16:40:00	Time	2	user2
10/09 16:38:59	Alarm	1	user1
10/09 16:36:20	Test	2	user2
10/09 15:31:40	Test	1	user1

- Recipient (mail address, message)
- Recipient (1: recipient 1, 2: recipient 2)
- Error code*
- Event (see the table below)
- Date/time

* See section 10.1, "A List of Messages."

Type	Description
Alarm	Alarm mail
Time	Scheduled mail
Report	Report timeout mail
Fail	Power failure recovery mail
Full	Memory full mail
Test	Test mail
Error	Error message mail

4.9 Displaying a List of Operation Logs

- **SNTP Log**

(004/004) Time	No.	Code
2005/10/10 10:10:10		SUCCESS
2005/10/10 09:10:10		SUCCESS
2005/10/10 08:10:10	294	OVER
2005/10/10 07:10:20	291	TIMEOUT

Error message (detail code)*
 Error code*
 Date/time

* See section 10.1, "A List of Messages."

- **DHCP Log**

(004/004) Time	No.	Code
2005/10/10 08:15:24	297	NONAHE
2005/10/10 08:15:24	565	IPCONFIG
2005/10/10 08:08:24	564	RENEWED
2005/10/10 08:08:18	565	IPCONFIG

Error message (detail code)*
 Error code*
 Date/time

* See section 10.1, "A List of Messages."

- **Modbus Status Log**

(012/200) Time	Kind	Factor	Command
2005/10/10 06:36:36	M	NONE	03 W
2005/10/10 06:36:36	M	Dropout	
2005/10/08 18:50:06	C	GOOD	02 R
2005/10/08 18:50:06	C	GOOD	01 R
2005/10/08 18:50:06	C		02 R

Command number, command type
 (R: read, W: write)
 Communication status*
 Communication type (C: client, M: master)
 Date/time

* See the *Communication Interface User's Manual*, IM 04L21B01-17EN.

4.10 Displaying Stacked Bar Graphs (/M1, /PM1, /PWR1, and /PWR5 Options)

This section explains how to use stacked bar graphs.

Procedure

- **Changing the Displayed Contents**
 1. Press **DISP/ENTER** to show the display selection menu.
 2. Press the **right arrow** key to display the sub menu.
 3. Press the **up and down arrow keys** to select the sub menu item.

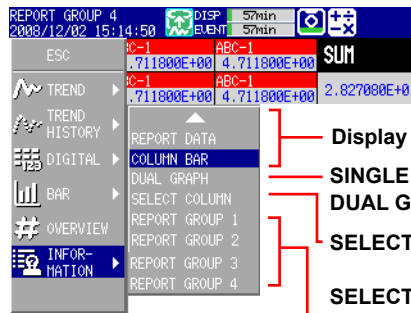

- Display name:** Switches to the specified display
- SINGLE GRAPH:** Displays a single graph
- DUAL GRAPH:** Displays two graphs
- SELECT GROUP:** Use the arrow keys to switch between displayed report groups.
- SELECT COLUMN:** Use the arrow keys to select a bar graph.
- REPORT GROUP 1 through 4*:** Select the report group that you want to display.

* Varies according to the model. For information about report groups, see section 9.5.

4. Press **DISP/ENTER** to change the displayed contents.
To close the menu without changing the display contents, press **ESC**.

- **Changing Groups, Selecting Bar Graphs, and Moving the Cursor**
The amount of data that the up and down arrow keys scroll through depends on the type of report data. For example, with an “H+D” report, you can use the arrows to scroll through the data one day at a time.

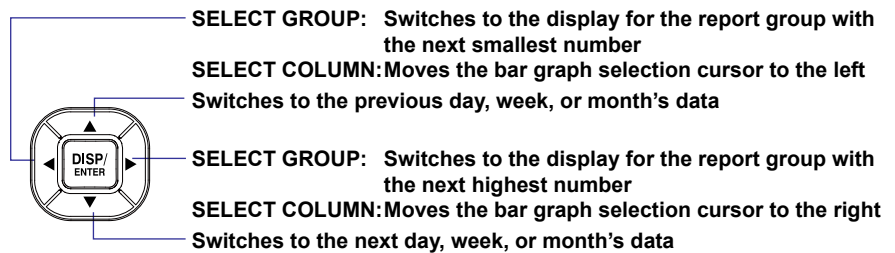

4.10 Displaying Stacked Bar Graphs (/M1, /PM1, /PWR1, and /PWR5 Options)

Explanation

- SINGLE GRAPH/DUAL GRAPH**

You can display one or two bar graphs. The sums of the first channel in a group and of all other channels that have the same unit as it are displayed.

- SINGLE GRAPH**

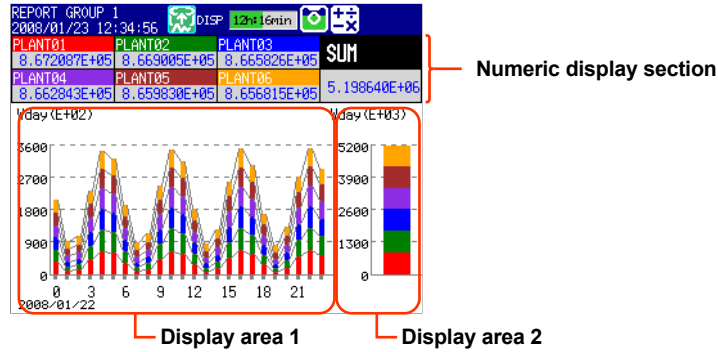

The displayed report data varies depending on the report kind, which is set using the report function.

Report kind	Display Area 1	Display Area 2
Hour, H+D	Sums for each hour	Sums for the day
Day+Week	Sums for each day	Sums for the week
Day, D+M	Sums for each day	Sums for the month

- DUAL GRAPH**

Shows the data from two consecutive periods at the top and bottom of the display.

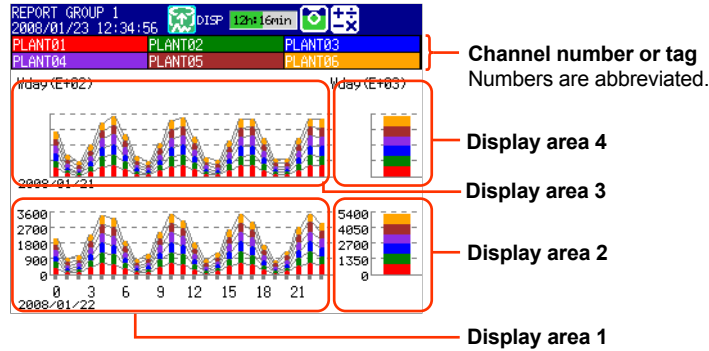

The displayed report data varies depending on the report kind, which is set using the report function. Display areas 1 and 2 contain the same report data listed above for SINGLE GRAPH display.

Report kind	Display Area 1	Display Area 2	Display Area 3	Display Area 4
Hour, H+D	Sums for each hour	Sums for the day	Sums for each hour	Sums for the day (The data of the day before the data in display areas 1 and 2)
Day+Week	Sums for each day	Sums for the week	Sums for each day	Sums for the week (The data of the week before the data in display areas 1 and 2)
Day, D+M	Sums for each day	Sums for the month	Sums for each day	Sums for the month (The data of the month before the data in display areas 1 and 2)

4.10 Displaying Stacked Bar Graphs (/M1, /PM1, /PWR1, and /PWR5 Options)

Note

The numbers on the vertical axis of display areas 3 and 4 and the dates on the horizontal axis are abbreviated.

Display areas 3 and 4 can only display the data from the period immediately preceding that of display area 1 and 2.

- **Selecting a Bar**

When SINGLE GRAPH is selected, you can move the cursor to a bar that you want to check, and view the sums of each channel.

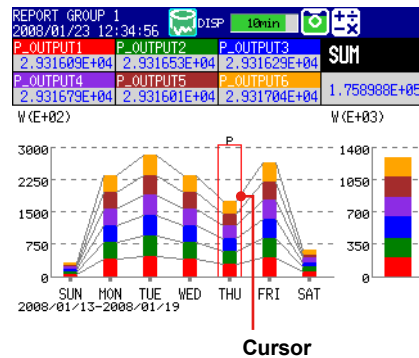

The sums of each channel and the sums of all channels of the report group at the cursor position

- **Power Failure and Time Adjustment Indications**

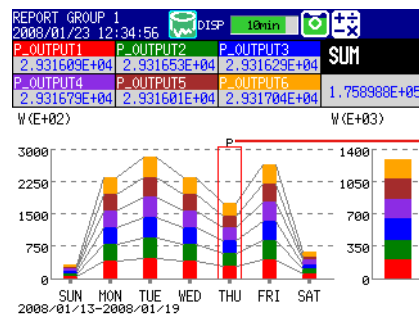

Indicates a power failure
A "C" appears if more than one report has been filed for the same time period.

- **Power failure**

A "P" indicates when a power failure occurred and a report was supposed to be filed. A "P" also indicates when the FX recovered from a power failure and the next report was filed.

- **Time adjustment**

When a time adjustment causes a report to be filed twice because the time was moved back, the time adjustment is marked with a "C," and the bar graph of the report that was filed first is used.

If the data for a period does not exist because of a power failure or time adjustment, a bar graph for the period will not be displayed.

5.1 Setting Display Groups

Assign channels and set the group name for each display group. Set lines at specified positions in the waveform display range on the Trend display.

Setup Screen

Press **MENU** (to switch to setting mode), and select the **Menu** tab > **Group set, Trip line**.

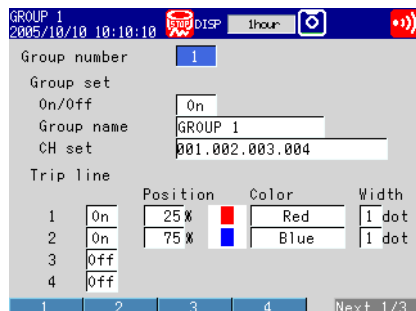

Setup Items

- **Group number**
Select the target group number (1 to 10).
- **Group**
 - **On/Off**
Turn **On** the groups you want to use.
 - **Group name**
Set the group name. (up to 16 characters, `[A|a|#|1]`)
 - **CH set**
Set up to six channels using the measurement channels and computation channels (/M1, /PM1, /PWR1, and /PWR5 options).
 - Enter the channel number using two or three digits.
 - Separate each channel with a period.
 - To specify a range of consecutive channels numbers, use a hyphen.
Example: To assign channels 1 and 5 to 8, enter "001.005-008."

Note

- The trend, digital, and bar graph displays are shown in the specified order.
- A channel can be assigned to multiple groups.
- The same channel cannot be assigned multiple times in a group.

5.1 Setting Display Groups

Note

The channel settings of a display group can be copied to another group.

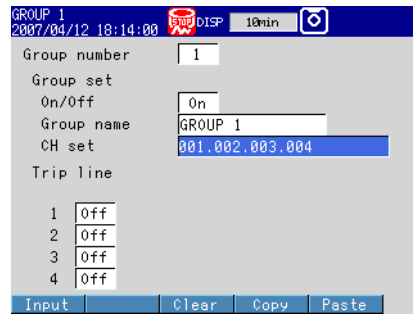

Procedure

1. Select the copy source channel settings.
 2. Press the **Copy** soft key.
 3. Select the copy destination channel settings.
 4. Press the **Paste** soft key. The channel settings are copied.
-

- **Trip line**

Set lines at specified positions in the waveform display range on the Trend display.

- **1, 2, 3 and 4**

Turn **On** the trip lines you want to display.

- **Position**

Set the position in the range of 0 to 100% of the display width.

- **Color**

The default colors are red, green, blue, and yellow. If you want to change the color, select from the 24 available colors.

- **Width**

Set the line width of the trip line in dots (1 to 3).

5.2 Displaying Tags or Channel Numbers

Display the channels using tags or channel numbers.

Setup Screen

- **Tag/Channel**

Press **MENU** (switch to the setting mode), hold down **FUNC** for 3 s (switch to the basic setting mode), and select **Environment > Operating Environment**.

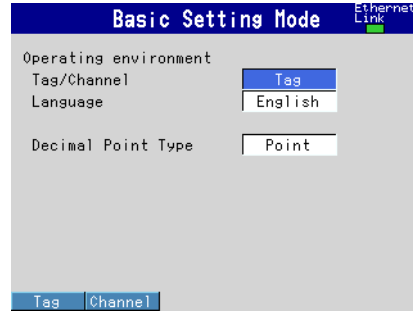

- **Tag**

Press **MENU** (to switch to setting mode), and select the **Menu** tab > **Meas channel > Tag, Memory, Delay**.

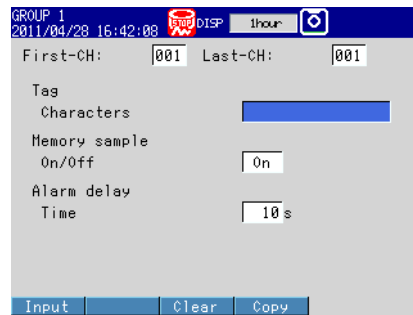

Setup Items

- **Operating environment > Tag/Channel**

This setting applies to all channels.

Setting	Description
Tag	Displays tags. If a tag has not been set, the channel number will be displayed.
Channel	Displays channel numbers.

- **First-CH, Last-CH**

Set the target channels. The target channels are common with the other items that are displayed on the screen.

- **Tag > Characters**

Set the tag using up to 16 characters: .

5.3 Setting the Trend Interval and Switching to the Secondary Trend Interval

Set the trend interval. Switch the trend interval to the secondary trend interval while the memory sampling is in progress. Automatically write messages when the trend interval is switched.

For a description of the function, see section 1.3.

Setup Screen

- **Switching the Trend Interval and Writing Messages (When Using the Secondary Trend Interval)**

Press **MENU** (to switch to setting mode), hold down **FUNC** for 3 s (to switch to basic setting mode), and select the **Environment** tab > **View, Message**.

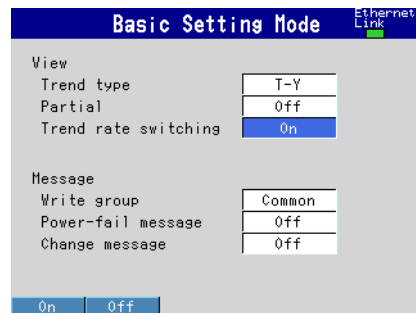

- **Trend interval [/div] and Secondary interval [/div]**

Press **MENU** (to switch to setting mode), and select the **Menu** tab > **Display** > **Trend/Save interval**.

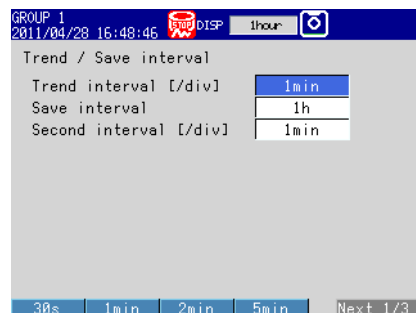

Setup Items

- **View > Trend rate switching**

On: Enables the function that switches the trend interval while the memory sampling is in progress. The "Second interval [/div]" item is displayed in the setting mode.

* When the trend rate switching function is **On**, the FX cannot be configured to record both the display and event data (see section 6.1).

- **Message > Change message**

On: Writes the time the interval is switched and the new trend interval as a message when the trend interval is switched.

5.3 Setting the Trend Interval and Switching to the Secondary Trend Interval

- **Trend interval [div] and Second interval [div]**

Select the time corresponding to 1 division of the time axis on the trend display from below: You cannot specify a trend interval that is faster than the scan interval.

15s,¹ 30s, 1min, 2min, 5min, 10min, 15min, 20min, 30min, 1h, 2h, 4h, 10h

¹ Selectable on the FX1002 and FX1004

Note

If the trend interval is set greater than or equal to 1h/div, the month, day, and hour at the grid position are displayed on the screen. The display format can be changed by setting the date format.

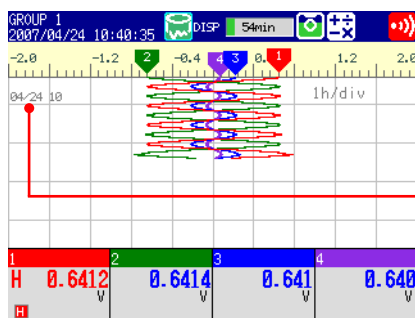

Month, day, and hour at the grid position.

Procedure

- **Switching the Trend Interval**

1. In the operation mode, press **FUNC**.
The Function menu appears.
2. Press the **Normal speed** soft key or **Second speed** soft key.
The trend interval is switched. A message is written on the trend display (when the change message is turned ON).
Display example: 10:53 1min/div

Note

Only the displayed time axis changes when you switch to the secondary trend interval. The data sampling interval does not change.

5.4 Writing Messages

Write messages.

Setup Screen

- **Message Write Group**

Press **MENU** (to switch to setting mode), hold down **FUNC** for 3 s (to switch to basic setting mode), and select the **Environment** tab > **View, Message**.

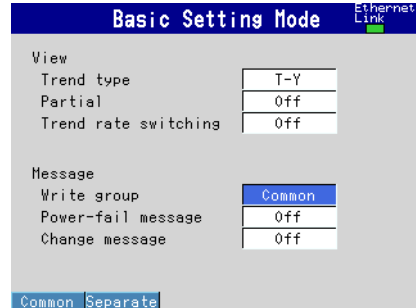

- **Setting the Messages**

Press **MENU** (to switch to setting mode), and select the **Menu** tab > **Message**.

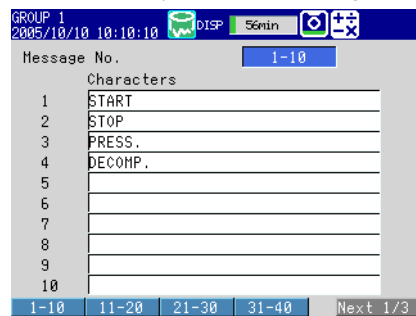

Setup Items

- **Message**

- **Write group**

This setting applies only for messages that are written using keys.

Settings	Description
Common	Write the message to all groups.
Separate	Write the message to the displayed group.

- **Power-fail message**

See section 5.15.

- **Change message**

See section 5.3.

- **Message No.**
Select the message number (1 to 100). Messages 1 to 10 are common with free messages.* If a message is changed as a free message, the old message is overwritten.
* Messages that are written by creating the message on the spot.
- **Message > Characters**
Set the message. (up to 32 characters, $[Aa\#1]$)

Procedure

- **Writing Messages**
Messages cannot be written when the memory sampling is stopped.
1. Display the group to write the message.
 - If a screen unrelated to a group such as the overview is displayed, messages are written to all groups even when **Write group** is set to **Separate**.
 - Messages are written to all groups regardless of the displayed screen when **Write group** is set to **Common**.
 2. Press **FUNC**.
The Function menu appears.
 3. Press the **Message** soft key.
 4. Press the **soft key** corresponding to the desired message number range (example: [1-10]).
A list of message is displayed.



5. Press the **soft key** corresponding to the number of the message you want to write.
A message mark, time, and message are shown on the trend display.

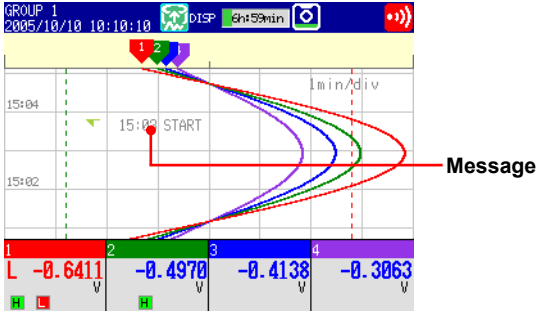

5.4 Writing Messages

- **Writing Free Messages**

Create a message on the spot and write it.

1. Display the group to write the message.
2. Press **FUNC**.
The Function menu appears.
3. Press the **Free message** soft key.
4. Press a message number **soft key**.
The message entry window appears.
5. Enter the message. (up to 32 characters, $[A|a|\#|1]$)
6. Select **ENT** and press **DISP/ENTER**.
A message mark, time, and message are shown on the trend display.

- **Writing Add Messages**

Add messages to the past data positions. This operation can be carried out on the past section of the data that is currently being memory sampled.

1. Carry out the procedure below to show the historical trend of the data that is currently being memory sampled.
Press **DISP/ENTER** and select **TREND HISTORY > (group name) > DISP/ENTER**
2. Press the **arrow keys** to move the cursor to the position you want to write the message.
3. Write the message according to the procedure given in “Writing Messages” or “Writing Free Messages.” Use the **Add Message** or **Add Free Message** soft key.

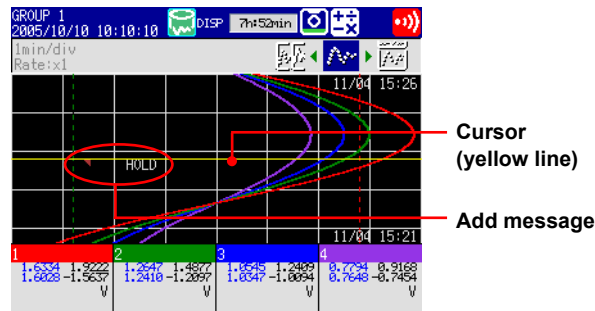

Explanation

- **Display Color of Messages**

The message colors on the trend display are shown below. You cannot change them.

No.	1	2	3	4	5	6	7	8	9	10
Color	Red	Green	Blue	Blue violet	Brown	Orange	Yellow-green	Light blue	Violet	Gray

The colors for messages 11 to 100 are repetitions of the colors above.

- **Add Message**

- The message timestamp is the time that the message is written. It is not the time stamp of the data at the position where the message is written.

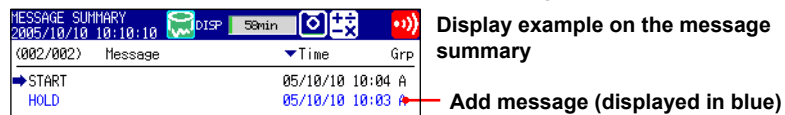

- Up to 50 messages can be written.
- Messages cannot be added to data in the internal memory that has already been saved to a file or data that has been loaded from the external storage medium.

5.5 Changing the Channel Display Colors

Change the channel display colors. The settings are applied to the trend and bar graph displays.

Setup Screen

Press **MENU** (to switch to setting mode), and select the **Menu** tab > **Meas channel** > **Color**.



Setup Items

- **Group of channel**
Select the target channels.
- **Color**
To change the color, select from the following 24 colors.
Red, green, blue, blue violet, brown, orange, yellow-green, light blue, violet, gray, lime, cyan, dark blue, yellow, light gray, purple, black, pink, light brown, light green, dark gray, olive, dark cyan, and spring green

5.6 Displaying Channels in Display Zones

Specify a waveform display zone for each channel so that waveforms do not overlap.
For a description of the function, see section 1.3.

Setup Screen

Press **MENU** (to switch to setting mode), and select the **Menu** tab > **Meas channel** > **Zone, Scale**

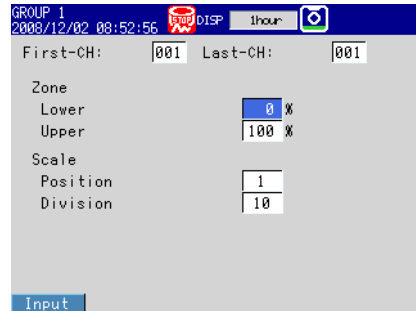

Setup Items

- **First-CH, Last-CH**
Select the target channels. The target channels are common with the other items that are displayed on the screen.
- **Zone > Lower, Zone > Upper**
Sets the zone in which the waveform is displayed. You can set **Lower** and **Upper** as a position (%) when taking the maximum display width to be 100%. Set **Upper** greater than **Lower**, and the zone width (**Upper – Lower**) greater than or equal to 5%.
Lower: 0 to 95%
Upper: 5 to 100%

5.7 Displaying a Scale on the Trend Display

Display a scale on the trend display.

For a description of the function, see section 1.3.

Setup Screen

- **Scale Position and Number of Scale Divisions**

Press **MENU** (to switch to setting mode), and select the **Menu** tab > **Meas channel** > **Zone, Scale**.

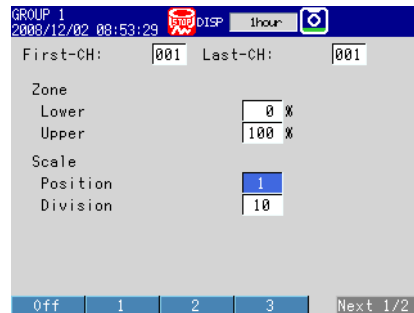

- **Number of Displayed Scale Digits and Current Value Indicator**

Press **MENU** (to switch to setting mode), and select the **Menu** tab > **Display** > **Trend**.



- **Showing the Scales**

To show scales on the trend display, press **DISP/ENTER** (show the display selection menu) > the **right arrow key** (show the sub menu), and select **SCALE ON** (see section 4.2).

Setup Items

- **First-CH, Last-CH**

Select the target channels. The target channels are common with the other items that are displayed on the screen.

- **Scale > Position**

Select the scale display position on the trend display from 1 to 6. Select **Off** if you do not wish to display the scale.

5.7 Displaying a Scale on the Trend Display

- **Scale > Division**

* This is not applied to the Log scale (/LG1 option).

Set the number of divisions to make with the main scale marks on the trend display to a value from **4** to **12** or **C10**.

C10: The scale is equally divided into 10 sections by main scale marks, and scale values are indicated at 0, 30, 50, 70, and 100% positions on the trend display.

The figure below shows different scale divisions for when the span is from 0 to 100 and the unit is M/H.

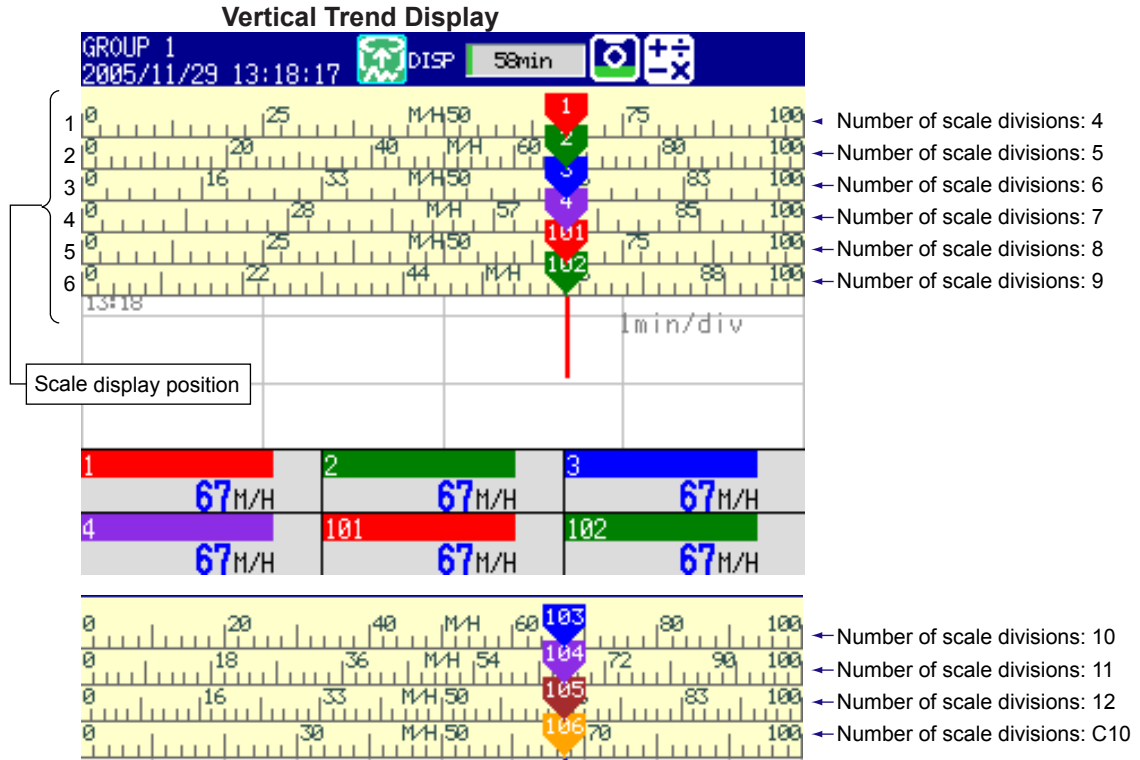

Horizontal Trend Display

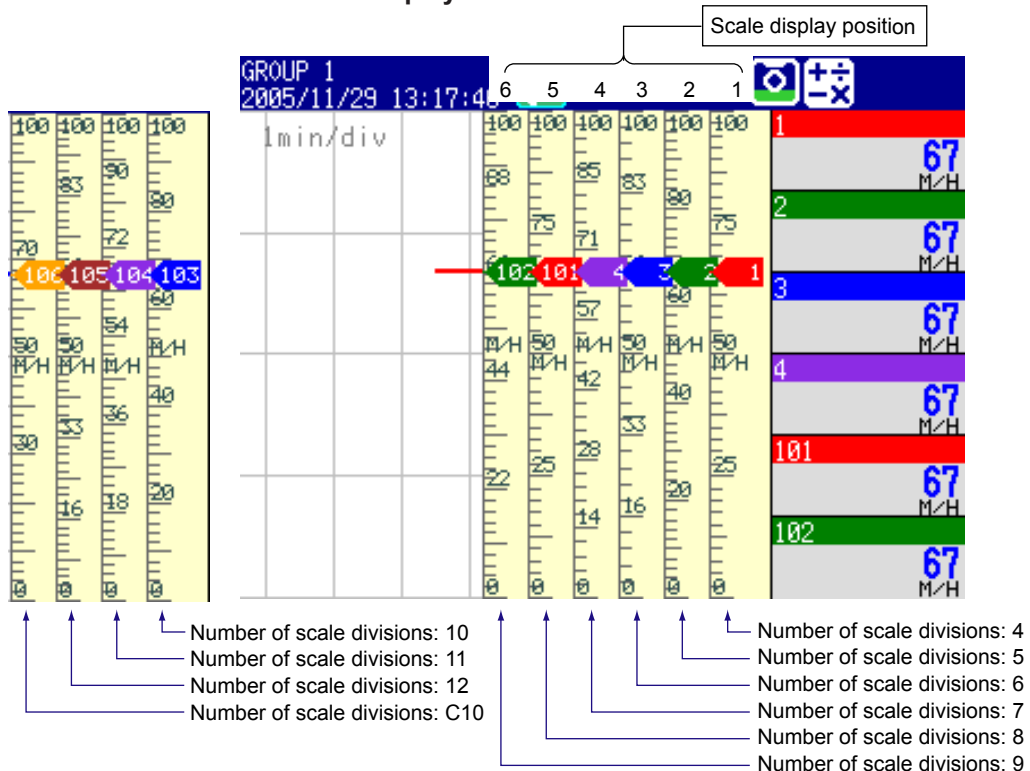

Note

- If the scales of multiple channels are set to the same position, the scale of the channel assigned first to the group is displayed.
Example: If the order of assignment of a group is **003.002.001**, and the scale display position of all channels is set to **1**, the scale of channel 3 is displayed at display position 1.
- Even if some of the scale display positions are skipped, the scale is packed towards display position 1.
Example: Suppose the assignment of channels to a group is **001.002.003**, and the display positions of the scales are set to 1, 3, and 6, respectively. The scales are actually displayed at positions 1, 2, and 3, respectively.
- The scale is divided into 4 to 12 sections by the main scale marks. The section between the main scale marks is divided into 5 or 10 subsections by medium and small scale marks. However, small scale marks are not displayed in the following cases.
 - When the resolution of the input range is smaller than the total number of small scale marks.
 - When zone display is used.
 - When partial expanded display is used (numbers are displayed at the ends of the scale and at the boundary position).
- The scale values are displayed according to the following rules.
 - If the number of scale divisions is 4 to 6 for the vertical trend display, values are displayed at all main scale marks. If the number of scale divisions is greater, the values are displayed at every other main scale marks.
 - Scale upper and lower limits are displayed at the ends of the scale.
 - Scale values are displayed up to 3 digits excluding the minus sign. However, if the integer part of values at the ends of the scale is both 1 digit or the integer part is zero, 2 digits are displayed.
Example: If the scale is -0.05 to 0.50 , the lower limit is -0.0 and the upper limit is 0.5 .
 - If the integer part of either end of the scale is 2 or 3 digits, the fractional part is truncated.
Example: If the scale is 0.1 to 100.0 , the lower limit is 0 and the upper limit is 100 .
 - If the integer part of either end of the scale is 4 or more digits, the value is displayed using a 3-digit mantissa and exponent like $\times 10$ or $\times 10^2$.
Example: If the scale is 10 to 2000 , the lower limit is 1 and the upper limit is 200×10 .
- The unit is displayed near the center of the scale. If partial expanded display is used, the display position is offset from the center. For the vertical trend display, the number of characters that can be displayed is up to six. For the horizontal trend display, the number of characters that can be displayed is up to three. However, if the scale digit display is set to Fine, up to four characters are displayed.

• **Trend > Scale > Digit**

* This is not applied to the Log scale (/LG1 option).

Fine: When the scale values are displayed using two digits, you can change it so that they are displayed using three digits.

For example, if the scale range is 49.0 to 50.0 and you select "Normal," the scale values are displayed using two digits (49 for example, see Note above). If you select "Fine," the scale values are displayed using three digits as shown below.

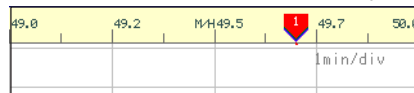

• **Trend > Scale > Value indicator**

The current value is displayed as a mark or a bar graph.

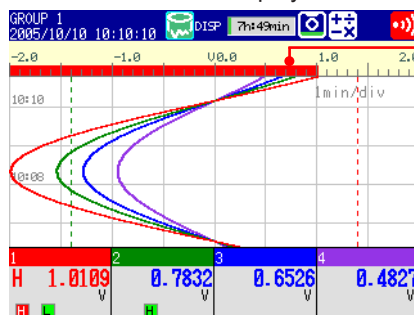

Bar graph

5.8 Displaying Alarm Point Marks and Color Scale Band on the Scale

Display alarm point marks on the scale. Display the specified range with a color band.

For a description of the function, see section 1.3.

When using the Log scale (/LG1 option), set the mantissa and the exponent to set the color scale band.

For the setting procedure, see the next page and section 3.13.

Setup Screen

Press **MENU** (to switch to setting mode), and select the **Menu** tab > **Meas channel** > **Alarm mark** or **Color scale band**.

• Alarm mark



• Color scale band



Setup Items

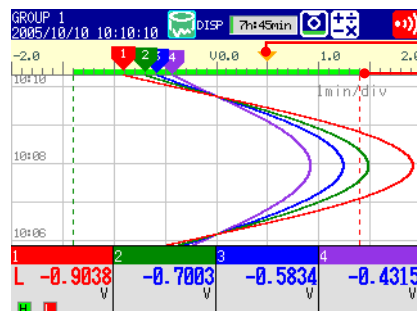

Alarm point mark
Color scale band

- **First-CH, Last-CH**
Select the target channels. The target channels are common with the other items that are displayed on the screen.
- **Alarm mark**
Displays marks indicating the values of the high and low limit alarms, delay high and low limit alarms, and difference high and low limit alarms. This setting is common with the bar graph display.
 - **Alarm mark > Mark kind**

Settings	Description	Mark
Alarm	The alarm mark is green under normal circumstances. It becomes red when an alarm occurs.	▼ or ▼
Fixed	Displays a fixed color.	▼
 - **Alarm mark > Indicate on Scale**
To display alarm point marks, select **On**.
 - **Alarm mark color > Alarm 1, Alarm 2, Alarm 3, and Alarm 4**
If the **Mark kind** is set to **Fixed**, specify the color of the alarm point marks.

- **Color scale band**

Displays a specified section of the measurement range using a color band on the scale. This setting is common with the bar graph display.

- **Color scale band > Band area**

Settings	Description
In	Displays the area inside using the color band.
Out	Displays the area outside using the color band.
Off	Disables the function.

- **Color scale band > Color**

Set the display color.

- **Color scale band > Display position > Lower, Upper**

* When you are using the Log scale (/LG1 option), set the settings by specifying the mantissas and exponents (see section 3.13).

Specify the display position. Set a value within the span or scale range.

Lower: Lower limit of the area.

Upper: Upper limit of the area.

5.9 Partially Expanding the Waveform

Expand a part of a waveform (shrink the other parts) on the display.

* You cannot specify a channel that is set to Log scale (LG1 option).

We recommend that you display the scale when viewing partially expanded channels.

The numbers for the ends of the scale and the boundary position are displayed, and you can identify the expanded and reduced areas easily. However, numbers are not displayed for other scale marks.

For a description of the function, see section 1.3.

Setup Screen

- **Turning ON/OFF the Partial Expanded Display Function**

Press **MENU** (to switch to setting mode), hold down **FUNC** for 3 s (to switch to basic setting mode), and select the **Environment** tab > **View, Message**.

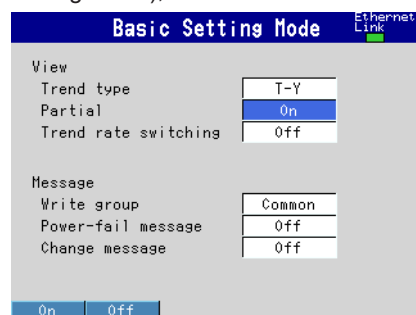

- **Partially Expanded Display Method**

Press **MENU** (to switch to setting mode), and select the **Menu** tab > **Meas channel** > **Partial**.

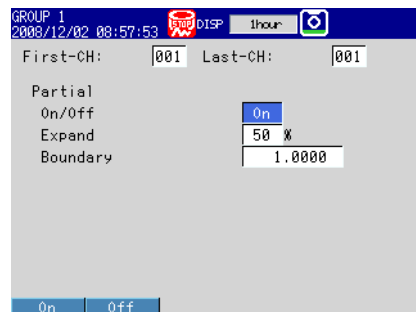

Setup Items

- **View > Partial**

If you select **On**, the **Partial** setup item appears in the setting mode.

- **First-CH, Last-CH**

Select the target channels.

- **Partial > On/Off**

To enable partial expanded display, select **On**.

- **Partial > Expand**

Set the position where the value specified by **Boundary** is to be displayed within the display span in the range of 1 to 99.

- **Partial > Boundary**

Set the value that is to be the boundary between the reduced section and the expanded section in the range of “minimum span value + 1 digit to maximum span value – 1 digit.” For channels that are set to scaling, the selectable range is “minimum scale value + 1 digit to maximum scale value – 1 digit.”

Example: Input range: –6 V to 6V. Expand: 30. Boundary: 0

The –6 V to 0 V range is displayed in the 0% to 30% range, and the 0 V to 6 V range is displayed in the 30% to 100% range.

5.10 Changing the Display Layout, Clearing of the Waveform at Start, Message Display Direction, Waveform Line Width, and Grid

Change the display layout, clearing of the waveform at start, waveform line width, and grid.

For a description of the function, see section 1.3.

Setup Screen

Press **MENU** (to switch to setting mode), and select the **Menu** tab > **Display** > **Trend**.

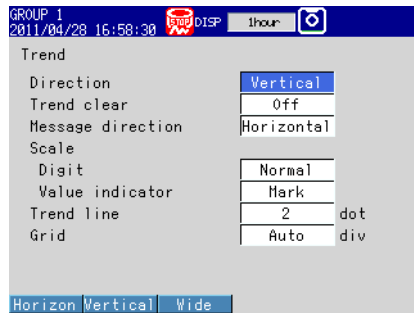

Setup Items

- **Trend > Direction**

Set the display direction of the trends to **Horizontal**, **Vertical**, or **Wide**.

- **Trend > Trend clear**

Settings	Description
----------	-------------

On	Clears the displayed waveform when the memory sampling is started.
----	--

Off	Does not clear the waveform when the memory sampling is started.
-----	--

- **Trend > Message direction**

Set the display direction of messages to **Horizontal** or **Vertical**. When the trend is set to **Vertical**, the message direction is fixed to **Horizontal**.

- **Trend > Trend line**

Set the line width of the trend in dots (1 to 3).

- **Trend > Grid**

Select the number of grids to be displayed in the waveform display area of the trend display.

Settings	Description
----------	-------------

4 to 12	Displays a grid that divides the display width into 4 to 12 sections.
---------	---

Auto	Displays the same number of grids as the number of scale divisions of the first assigned channel of the group. When the target channel is set to Log scale (LG1 option), the logarithmic grid is used.
------	--

5.11 Changing the Bar Graph Display Method

Change the bar graph display method.

For a description of the function, see section 1.3.

Setup Screen

- **Display Direction**

Press **MENU** (to switch to setting mode), and select the **Menu** tab > **Display** > **Bar graph**.

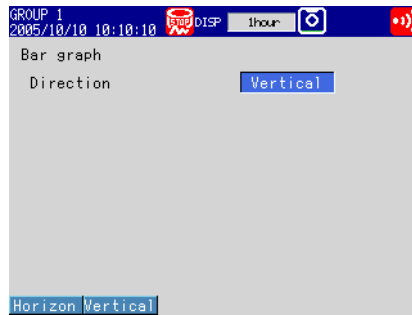

- **Base Position and the Number of Scale Divisions**

Press **MENU** (to switch to setting mode), and select the **Menu** tab > **Meas channel** > **Bar graph**.

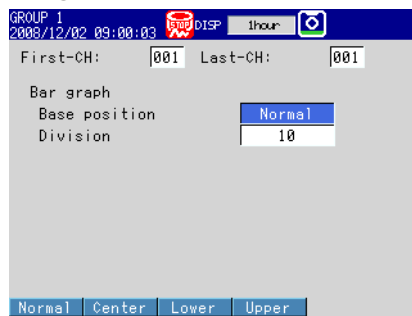

Setup Items

- **Bar graph > Direction**

Set the display direction of bar graphs to **Horizontal** or **Vertical**.

- **First-CH, Last-CH**

Set the target channels. The target channels are common with the other items that are displayed on the screen.

- **Bar graph > Base position**

Set the bar graph base position to **Normal**, **Center**, **Lower**, or **Upper**. This setting is applied when you are displaying the current value on the scale as a bar graph on the bar graph and trend displays.

5.11 Changing the Bar Graph Display Method

When the Display Direction of the Bar Graph Is Vertical

- Normal
 Value at the bottom of the bar graph: Span lower limit or span upper limit (or scale lower limit or scale upper limit), whichever is less
 Value at the top of the bar graph: Span lower limit or span upper limit (or scale lower limit or scale upper limit), whichever is greater
 Starting point of the bar: Bottom edge
- Center
 Value at the bottom of the bar graph: Same as with Normal.
 Value at the top of the bar graph: Same as with Normal.
 Starting point of the bar: Center
- Lower
 Value at the bottom of the bar graph: Span lower limit (or scale lower limit)
 Value at the top of the bar graph: Span upper limit (or scale upper limit)
 Starting point of the bar: Bottom edge
- Upper
 Value at the bottom of the bar graph: Same as with Lower.
 Value at the top of the bar graph: Same as with Lower.
 Starting point of the bar: Top edge

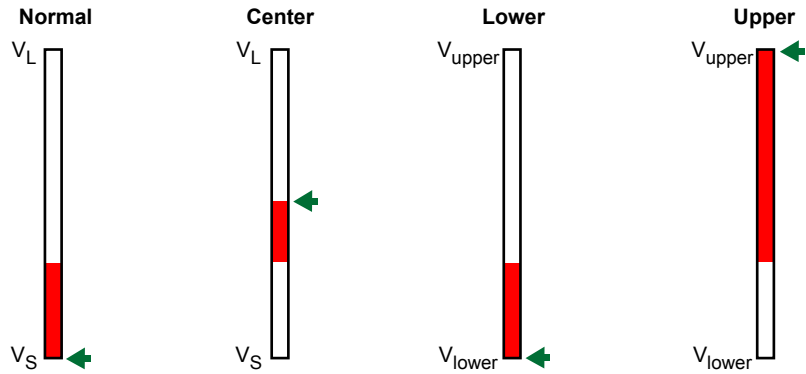

V_{upper} : Span upper limit (or scale upper limit)
 V_{lower} : Span lower limit (or scale lower limit)
 V_L : V_{lower} or V_{upper} , whichever is greater
 V_S : V_{lower} or V_{upper} , whichever is less
 \leftarrow : Starting point of the bar

Example: When the span lower and upper limits of the input range are 0.0 and -100.0, respectively.

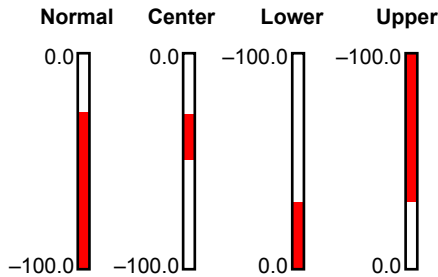

When the Display Direction of the Bar Graph Is Horizontal

The span lower limit (or scale lower limit) becomes the left edge of the bar graph, and the span upper limit (or scale upper limit) becomes the right edge of the bar graph.

- Starting point of the bar
 - Normal: Left edge or right edge, whichever is less
 - Center: Center
 - Lower: Left edge
 - Upper: Right edge

Normal

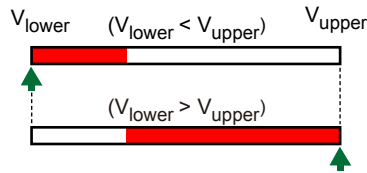

Lower

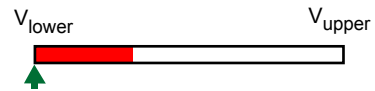

Center

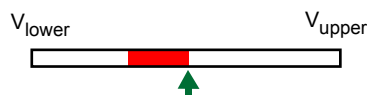

Upper



V_{upper}: Span upper limit (or scale upper limit)
 V_{lower}: Span lower limit (or scale lower limit)
 ▲: Starting point of the bar

Example: When the span lower and upper limits of the input range are 0.0 and -100.0, respectively

0.0 -100.0

Normal

0.0 -100.0

Center

0.0 -100.0

Lower

0.0 -100.0

Upper

When Displaying the Current Value on the Scale Using the Bar Graph

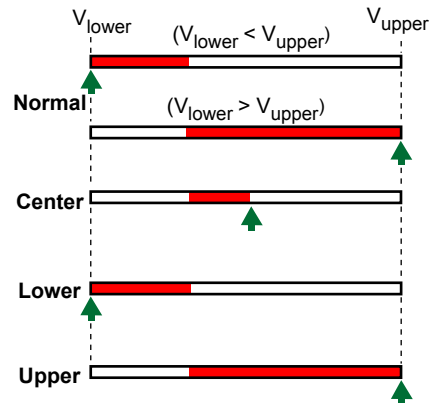
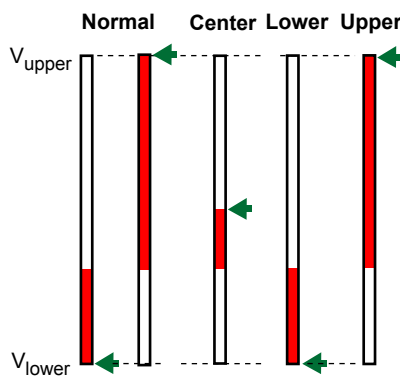

- Bar graph > Division**
 Select the number of main scale marks from 4 to 12.

5.12 Changing the Background Color of the Display

Change the background color of the display. This setting is applied to the operation screens.

Setup Screen

Press **MENU** (to switch to setting mode), and select the **Menu** tab > **Display** > **Monitor**.

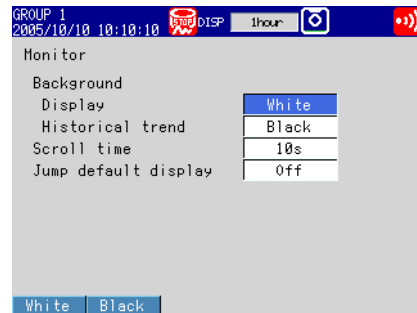

Setup Items

- **Monitor > Background > Display**
Set the background color of the operation screen to **White** (default setting) or **Black**.
- **Monitor > Background > Historical trend**
Select the background color of the historical trend display from the following:
Settings: **White**, **Black** (default setting), **Cream**, and **Lightgray**

5.13 Automatically Switching Display Groups

Automatically switch the displayed group at a specified interval.

Setup Screen

Press **MENU** (to switch to setting mode), and select the **Menu** tab > **Display** > **Monitor**.

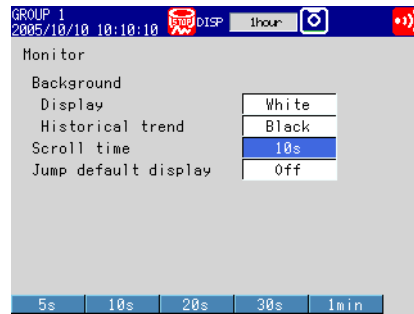

Setup Items

- **Monitor > Scroll time**
Set the switching interval from the available settings between 5 s and 1 min. The groups switch in ascending order.
Select whether to automatically switch on the display selection menu.
See section 4.2

5.14 Automatically Switching Back to the Default Display

Show a preset display when there is no operation for a specific time.

Setup Screen

Press **MENU** (to switch to setting mode), and select the **Menu** tab > **Display** > **Monitor**.

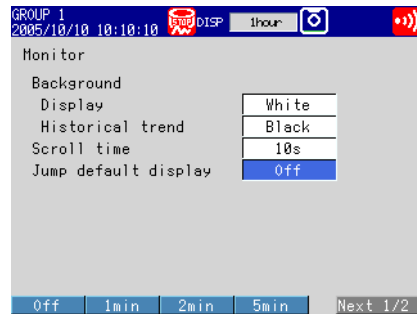

Setup Items

- **Monitor > Jump default display**

Returns to a preset display if there is no key operation for a specific time.

Settings	Description
1min to 1h	Time until switching the display.
Off	Disables the function.

Procedure

- **Specifying the Display to be Shown**

1. Show the operation display you want to designate.
2. In the operation mode, press **FUNC**.
The Function menu appears.
3. Press the **Standard display** soft key.
The display is registered.

5.15 Writing a Message When the FX Recovers from a Power Failure

A message is written to the trend display when the FX recovers from a power failure while memory sampling is in progress.

Setup Screen

- **Power-fail message**

Press **MENU** (to switch to setting mode), hold down **FUNC** for 3 s (to switch to basic setting mode), and select the **Environment** tab > **View, Message**.

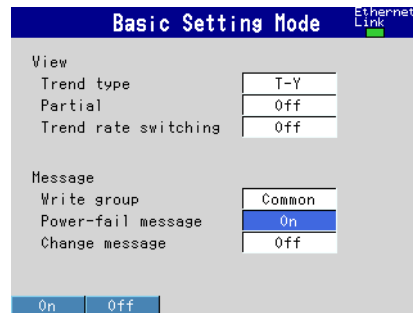

Setup Items

- **Message > Power-fail message**

Settings	Description
On	A message is written when the FX recovers from a power failure while memory sampling is in progress. Display example: 15:12 Power Off 2005/10/25 15:12:57
Off	Disables the function.

5.16 Changing the Function menu and Display Selection Menu

You can change the contents of the Function menu, which is displayed when you press FUNC, and the display selection menu, which is displayed when you press DISP/ENTER.

Setup Screen

- **Function menu**

Press **MENU** (to switch to setting mode), and select the **Menu** tab > **Menu customize** > **Function menu**.

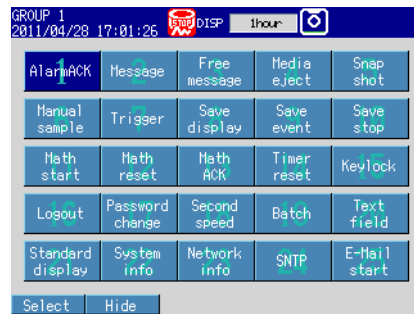

Number indicating the display order



Menu name
White: Used
Gray: Not used

- **Display Menu**

Press **MENU** (to switch to setting mode), and select the **Menu** tab > **Menu customize** > **Display menu**.

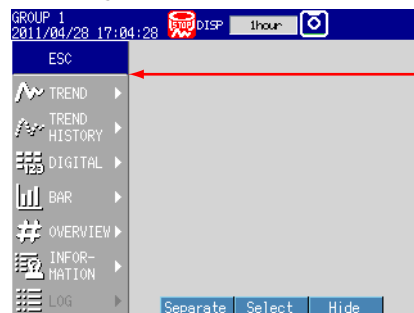

Separator

Setup Items

- **Enabling and Disabling the Function menu**

Items whose menu name is white are shown.

1. Press the **arrow keys** to select a menu item.
2. Press the **View** or **Hide** soft key.

If you press the **Hide** soft key, the menu name is displayed in gray, and does not appear in the Function menu.

- **Changing the Display Order of the Function menu Items**

Menu items are displayed in order by number. In addition, menu items appear when the corresponding function can be used.

1. Press the **arrow keys** to select a menu item.
2. Press the **Select** soft key.
The menu item is enclosed in a red frame.
3. Press the **arrow keys** to select the destination.
4. Press the **Transfer** soft key.
The menu item moves to the selected number position.

- **Description of Function menu Items**

For a description of each item, see section 4.1.

- **Enabling/Disabling the Display Selection Menu and Sub Menu**

Items whose menu name is white are shown.

1. Press the **arrow keys** to select a menu item.

2. Press the **View** or **Hide** soft key.

If you press the **Hide** soft key, the menu name is displayed in gray, and does not appear in the display selection menu.

- **Changing the Display Selection Menu/Sub Menu Positions**

1. Press the **arrow keys** to select a menu item.

2. Press the **Select** soft key.

The menu item is enclosed in a red frame.

3. Press the **arrow keys** to select the destination.

4. Press the **Transfer** soft key.

The menu item moves to the selected position.

- **Showing/Hiding Separators**

1. Press the **arrow keys** to select a menu item.

2. Press the **Separate** soft key.

A separator (line) is displayed between the current item and the lower item.

If you select a menu item whose separator is already shown, this operation hides the separator.

You can set up to three separators in the display selection menu and each sub menu.

5.16 Changing the Function menu and Display Selection Menu

- **Description of the Display Selection Menus and Sub Menus**

Items with asterisk (*) are set to **Hide** by default.

Display Selection Menu	Sub Menu	Reference Section
TREND	GROUP 1 to GROUP 10	Section 4.2
	ALL CHANNEL/GROUP CHANNEL	Section 4.2
	SCALE ON/OFF	Section 4.2
	DIGITAL OFF/ON	Section 4.2
	MESSAGE DISP2/1	Section 4.2
	* TREND SPACE ON/OFF	Section 4.2
	AUTO SCROLL ON/OFF	Section 4.2
TREND HISTORY	GROUP 1 to GROUP 10	Section 4.3
DIGITAL	GROUP 1 to GROUP 10	Section 4.2
	AUTO SCROLL ON/OFF	Section 4.2
BAR	GROUP 1 to GROUP 10	Section 4.2
	AUTO SCROLL ON/OFF	Section 4.2
OVERVIEW	CURSOR OFF/ON	Section 4.4
	JUMP TO ALM SUM	Section 4.4
	JUMP TO TREND	Section 4.4
	* JUMP TO DIGITAL	Section 4.4
	* JUMP TO BAR	Section 4.4
INFORMATION	ALARM SUMMARY	Section 4.6
	MESSAGE SUMMARY	Section 4.7
	MEMORY SUMMARY	Section 4.8
	* MODBUS CLIENT	Section 4.5
	* MODBUS MASTER	Section 4.5
	* RELAY	Section 4.5
	REPORT DATA	Section 4.5
	COLUMN BAR	Section 4.10
	TO HISTORY	Sections 4.6, 4.7, and 4.8
	TO HISTORY(DISP)	Sections 4.6, 4.7, and 4.8
	TO HISTORY(EV)	Sections 4.6, 4.7, and 4.8
	TO OVERVIEW	Section 4.6
	DISP GROUP OFF/ON	Section 4.7
	CHANGE SORT KEY	Sections 4.6 and 4.7
	ASCENDING ORDER/ DESCENDING ORDER	Sections 4.6 and 4.7
	DATA SAVE MODE	Section 4.8
	SELECT SAVE	Section 4.8
	* M.SAMPLE SAVE	Section 4.8
	* REPORT SAVE	Section 4.8
	ALL SAVE	Section 4.8
	CHANGE DISP ITEM	Section 4.7
	CHANGE DATA KIND	Section 4.8
	FILENAME DISPLAY/TIME DISPLAY	Section 4.8
	CHANGE REPORT CH	Section 4.5
	SINGLE GRAPH/DUAL GRAPH	Section 4.10
	SELECT COLUMN/SELECT GROUP	Section 4.10
	REPORT GROUP 1 to 4	Section 4.10
*Log	LOGIN	Section 4.9
	ERROR	Section 4.9
	COMMUNICATION	Section 4.9
	FTP	Section 4.9
	MAIL	Section 4.9
	WEB	Section 4.9
	SNTP	Section 4.9
	DHCP	Section 4.9
	MODBUS	Section 4.9

6.1 Setting the Recording Conditions of the Measured Data

Set the method for recording the measured data.
 For a description of the function, see section 1.4.

Setup Screen

- Data Type**

Press **MENU** (to switch to setting mode), hold down **FUNC** for 3 s (to switch to basic setting mode), and select the **Menu** tab > **A/D, Memory**.

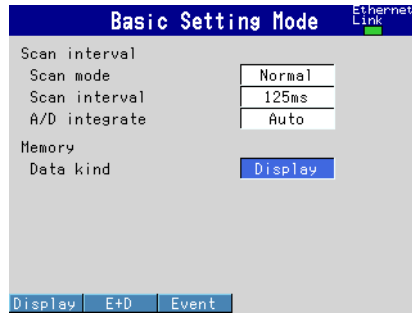

- Measurement Channels**

Press **MENU** (to switch to setting mode), and select the **Menu** tab > **Meas channel** > **Tag, Memory, Delay**.

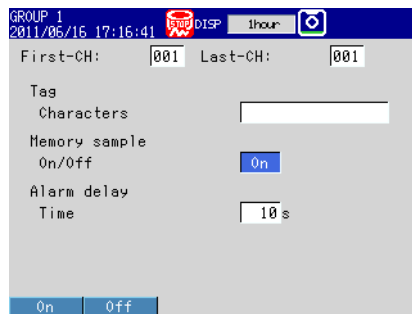

- File Save Interval (Display Data)**

Press **MENU** (to switch to setting mode), and select the **Menu** tab > **Display** > **Trend/Save interval**.

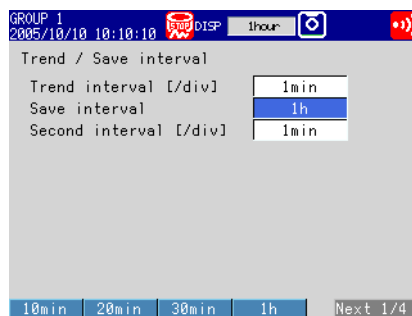

6.1 Setting the Recording Conditions of the Measured Data

- **Recording Conditions of Event Data***

Press **MENU** (to switch to setting mode), and select the **Menu** tab > **Data save** > **Event data**.

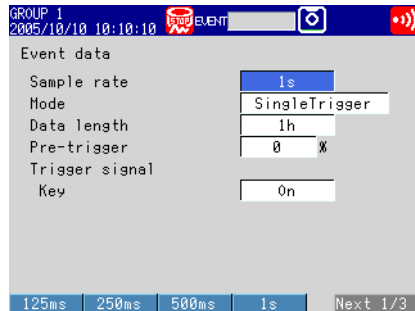

* When you set the type of data that you want to save to "Display," which is the default value, "Event data" is not displayed in the sub menu. Change the Data kind setting on the A/D, Memory screen in basic setting mode.

Setup Items

- **Memory > Data kind**

Settings	Description
Display	Records display data.
E+D	Records display data and event data. This setting cannot be selected when the trend interval switching function is set to On.
Event	Records event data.

- **Memory sample > On/Off**

Turn **On** the target channels.

Settings	Description
On	Measured data is recorded. Waveforms are displayed on the trend display.
Off	Measured data is not recorded. Even when registered in a display group, waveforms are not displayed in the trend display.

- **Trend/Save interval > Trend interval [/div] (when recording display data)**

See the table below. You can only set trend intervals that are longer than the scan interval you set in Basic Setting Mode.

- **Trend/Save interval > Save interval (when recording display data)**

Select the size of a record data file. The recorded data is divided by the file size specified here. The available settings vary depending on the number of memory sampling channels and the **Trend interval** setting.

Trend interval¹	15 s²	30 s	1 min	2 min	5 min
Sample rate	500 ms	1 s	2 s	4 s	10 s
Selectable range of save interval	10 min to 3 days	10 min to 7 days	10 min to 14 days	10 min to 14 days	10 min to 31 days
Trend interval¹	10 min	15 min	20 min	30 min	1 h
Sample rate	20 s	30 s	40 s	1 min	2 min
Selectable range of save interval	10 min to 31 days	10 min to 31 days	1 hour to 31 days	1 hour to 31 days	1 hour to 31 days
Trend interval¹	2 h	4 h	10 h		
Sample rate	4 min	8 min	20 min		
Selectable range of save interval	2 hours to 31 days	4 hours to 31 days	8 hours to 31 days		

¹ You cannot set a trend interval that corresponds to a sampling interval that is faster than the scan interval.

² Selectable on the FX1002 and FX1004

- **Trend/Save interval > Second interval [/div]**

See section 5.3.

- **Event data (when recording event data)**

- **Sample rate**

Select the data recording interval. Use the table under “Data length” for reference.

- **Mode**

Settings	Description
Free	Records data continuously.
Single	Records data when the trigger condition is met.
Repeat	Records data each time the trigger condition is met.

- **Data length**

Select the size of a record data file. The recorded data is divided by the file size specified here. The available data lengths vary depending on the number of memory sampling channels and the **Sample rate** setting.

Sample rate¹	125 ms	250 ms	500 ms	1 s	2 s
Selectable range of data length	10 min to 1 day	10 min to 2 days	10 min to 3 days	10 min to 7 days	10 min to 14 days
Sample rate¹	5 s	10 s	30 s	1 min	2 min
Selectable range of data length	10 min to 31 days	10 min to 31 days	1 hour to 31 days	1 hour to 31 days	1 hour to 31 days
Sample rate¹	5 min	10 min			
Selectable range of data length	1 hour to 31 days	1 hour to 31 days			

¹ You cannot choose a sample rate that is higher than the scan interval.

- **Pre-trigger**

Specify the range when recording data before the trigger condition is met. Select the range as a percentage of the data length from **0, 5, 25, 50, 75, 95, and 100%**. If you do not want to record the data existing before the trigger condition is met, select **0%**.

- **Trigger signal > Key**

Select **On** if you want to activate the trigger using key operation.

Note

- Triggers can be applied using event action (see section 7.1).
- If the trigger condition is already met when you press START, recording starts.

6.2 Setting the Method for Saving the Data

This section explains how to select a method for saving measured data to an external storage medium.

For a description of the function, see section 1.4.

Setup Screen

- **Auto save***

* This is only valid on FXs that have a CF card slot/SD card slot.

Press **MENU** (to switch to setting mode), hold down **FUNC** for 3 s (to switch to basic setting mode), and select the **Environment** tab > **Security, Media save**.

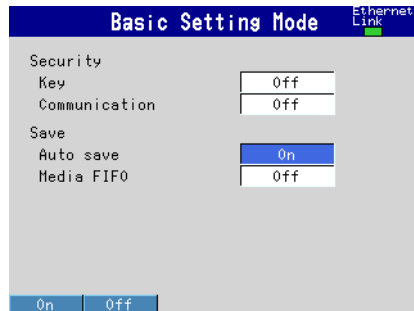

- **File header, Data file name**

Press **MENU** (to switch to setting mode), and select the **Menu** tab > **Data save** > **File header, File name**.

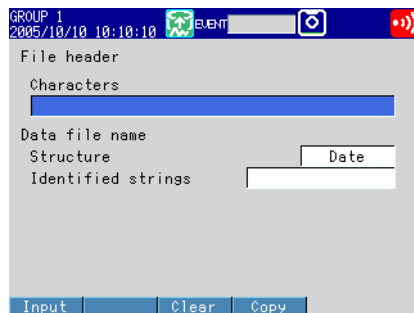

- **Save directory***

* This is only valid on FXs that have a CF card slot/SD card slot or USB interface (/USB1 option).

Press **MENU** (to switch to setting mode), and select the **Menu** tab > **Data save** > **Save directory**.

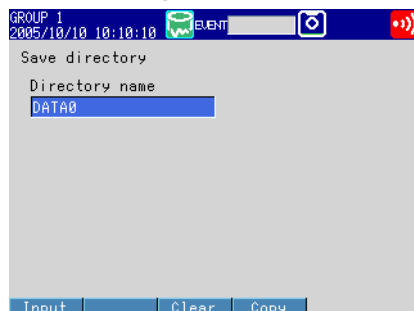

Setup Items

- **Save > Auto save***

* This is only valid on FXs that have a CF card slot/SD card slot.

Settings	Description
On	Automatically saves the measured data to the CF card/SD card. Specify On to enable the media FIFO function.
Off	Does not automatically save the data. Save the measured data manually to the CF card/SD card or USB flash memory (/USB1 option).

- **Save > Media FIFO***

* This is only valid on FXs that have a CF card slot/SD card slot.

This item appears if Auto save is set to On.

Settings	Description
On	Enable media FIFO. Constantly retains the most recent data files in the CF card/SD card.
Off	Disable media FIFO. Replace the CF card/SD card if the free space on the CF card/SD card drops low.

- **File header > Characters**

Set the header to be written to the data file. (Up to 50 characters, $[Aa\#1]$)

- **Data file name > Structure**

Sets the structure of the file name when saving data.

Settings	Description
Date	Serial number + user-assigned character string + date
Serial	Serial number + user-assigned character string
Batch	Serial number + batch name (when using the batch function)

- **Data file name > Identified strings**

Set the user-assigned section of the file name. (Up to 16 characters, $[Aa\#1]$)

Symbols that can be used: #, %, (,), +, -, ., @, °, and _.

For details on the data file name, see section 1.4.

- **Save directory > Directory name***

* This is only valid on FXs that have a CF card slot/SD card slot or USB interface (/USB1 option).

Set the name of the directory on the storage medium for saving the data on the external storage medium. (Up to 20 characters, $[Aa\#1]$)

Symbols that can be used: #, %, (,), +, -, ., @, °, and _.

Strings that cannot be used: AUX, CON, PRN, NUL, CLOCK, COM1 to COM9, and LPT1 to LPT9.

6.3 Using the Batch Function

Set the batch function.

For a description of the function, see section 1.5.

Setup Screen

- **Batch Function**

Press **MENU** (to switch to setting mode), hold down **FUNC** for 3 s (to switch to basic setting mode), and select the **Environment** tab > **Batch**.

The screenshot shows the 'Basic Setting Mode' screen. At the top, it says 'Basic Setting Mode' and 'Ethernet Link' with a green indicator. The main area contains the following settings:

Batch	On/Off	On
Lot-No. digit		6
Auto increment		On

At the bottom, there are two buttons: 'On' and 'Off'.

- **Data file name**

Press **MENU** (to switch to setting mode), and select the **Menu** tab > **Data save** > **File header, File name**.

The screenshot shows the 'Data file name' setup screen. At the top, it displays 'GROUP 1', '2005/01/01 02:01:05', 'STOP DISP', '1hour', and a refresh icon. The main area contains the following fields:

File header
Characters: [Empty text box]

Data file name
Structure: [Batch]

At the bottom, there are three tabs: 'Date', 'Serial', and 'Batch'.

- **Text Field**

Press **MENU** (to switch to setting mode), and select the **Menu** tab > **Data save** > **Batch text**.

The screenshot shows the 'Text Field' setup screen. At the top, it displays 'GROUP 1', '2005/01/01 02:01:43', 'STOP DISP', '1hour', and a refresh icon. The main area contains the following fields:

Text field number: [1]

Title of field: [Empty text box]

Characters: [Empty text box]

At the bottom, there are three buttons: 'Input', 'Clear', and 'Copy'.

Setup Items

- **Batch > On/Off**
Select **On** to use the batch function.
- **Batch > Lot-No. digit**
Select the number of digits of the lot number from 4, 6, or 8. Select **Off** to disable the lot number.

- **Batch > Auto increment**

Settings	Description
On	Automatically sets the lot number of the next measurement to “the lot number of the current measurement + 1.”
Off	Disables the operation described above.

- **Data file name > Structure**

Batch: Sets the names of the display data files or event data files to “serial number + batch name.”

For details on the data file name, see section 1.4.

- **Text field number**

Select a number from 1 to 8.

- **Text field > Title of field or Characters**

Set the string.

Title of field: (Up to 20 characters, $\boxed{\text{A|a|\#|1}}$), Characters: (Up to 30 characters, $\boxed{\text{A|a|\#|1}}$)

Procedure

- **Setting the Batch Name (Batch number + lot number) and Comment**

1. In the operation mode, press **FUNC**.
The Function menu appears.
2. Press the **Batch** soft key.
A window appears for you to enter the batch name and comment.
3. Set the batch number. (Up to 32 characters, $\boxed{\text{A|a|\#|1}}$)
Symbols that can be used: #, %, (,), +, -, ., @, °, and _.

If you are using the lot number, set the lot number.
4. Set batch comments 1, 2, and 3. (Up to 50 characters each, $\boxed{\text{A|a|\#|1}}$)
5. Press **DISP/ENTER**.

Note

- Batch numbers and lot numbers cannot be changed after memory start.
- You can change the comment as many times as you wish before executing memory start. After memory start, only the comments that are not specified can be entered. You can change the comment as many times as you wish while the window for setting the comment is displayed. The last specified comment is valid.
- The comment is cleared when memory stop is executed.
- The batch number, lot number, and comments are saved to the display data file or event data file. They are not saved to the setup file.

6.3 Using the Batch Function

- **Displaying Text Field Settings**
 1. In the operation mode, press **FUNC**.
The Function menu appears.
 2. Press the **Text field** soft key.
The text field settings appear.



6.4 Starting and Stopping Recording and Saving Measured Data

This section explains how to start recording and save measured data to the internal memory.

You can also save the measured data that is stored in internal memory to an external storage medium.*

* This is only valid on FXs that have a CF card slot/SD card slot or USB interface (/USB1 option).

For a description of the function, see section 1.4.

Procedure

- **Starting the Recording (Memory Start)**

Press **START**. The internal memory icon in the status display section changes from the stop icon to memory sampling icon.

- When recording display data or event data in free mode, recording starts.
- When recording event data in trigger mode, the FX enters the trigger-wait condition.

- **Applying a Trigger to Start the Recording**

Carry out the procedure below when the FX is waiting for a trigger.

Trigger through Key Operation

The procedure below can be carried out when recording event data in trigger mode and the FX is configured so that the start trigger is applied through key operation.

1. Press **FUNC**.
The Function menu appears.
2. Press the **Trigger** soft key.
The recording starts.

Trigger by an Event (Event action function must be configured. See section 7.1.)

Recording starts when an event occurs.

- **Automatically Saving Measured Data**

Automatic saving takes place when **Auto save** is set to **On** (see section 6.2 for details). The save destination is the CF card/SD card.*

* This is only valid on FXs that have a CF card slot/SD card slot.

Have the CF card/SD card inserted in the slot at all times. While the memory sampling is in progress, the measured data recorded in the internal memory is automatically saved to the CF card/SD card.

Action when Media FIFO is not enabled: If data is not completely saved to the external storage medium such as due to insufficient free space, the next time that data is automatically saved, the unsaved data will be saved.

6.4 Starting/Stopping the Recording and Saving the Measured data

- **Creating a Display Data File or an Event Data File**

This operation can be carried out when recording display data or when recording event data in **Free** mode. The file is created in the internal memory.

If **Auto save** is set to **On**, the data file is saved to the CF card/SD card at the same time.

1. In the operation mode, press **FUNC**.
The Function menu appears.
2. Press the **Save display** or **Save event** soft key.
The display data or event data is saved to the CF card/SD card.

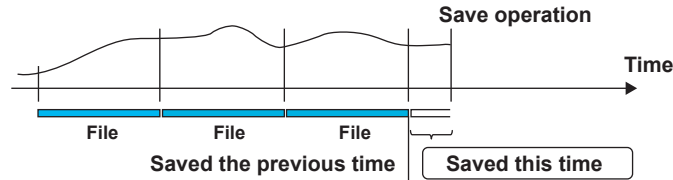

- **Saving Measured Data Manually (Collectively Storing Unsaved Data)**

This is the case for manually saving where **Auto save** is set to **Off** (see section 6.2 for details).

You can save to a CF card/SD card or to USB flash memory (/USB1 option). The procedure for saving unsaved data to a CF card/SD card is described below.

For the procedure to save data to the USB flash memory, see section 2.11.

1. Insert the CF card/SD card.
A confirmation window containing the message "There is data which is not saved to media. Do you want to store to media?" appears.
2. Select **Yes** and press **DISP/ENTER**.
The unsaved data in internal memory will be saved to the CF card/SD card.
3. Follow these steps to remove the CF card/SD card.
Press **FUNC** (to display the Function menu) > **Media eject** soft key > **CF/SD** soft key.
When the message "Media can be removed safely" appears, remove the CF card/SD card.

Note

- If there is not enough space on the external storage medium, the message "Not enough free space on media" appears, and the data is not saved. If this message appears, replace the external storage medium. Then, carry out the procedure again.
 - You cannot abort the data save operation while it is in progress.
-

- **Stopping the Recording (Memory Stop)**

1. Press **STOP**. A confirmation window is displayed.

If you are using the batch function, the batch name and comment are displayed on the screen.



2. Select **Yes** using the **arrow keys** and press **DISP/ENTER**.

If the FX is equipped with computation functions (/M1, /PM1, /PWR1, and /PWR5 options), select **Mem+Math** or **Memory**, and then press **DISP/ENTER**.

The internal memory icon in the status display section changes to the stop icon.

- **Saving the Data in the Internal Memory Collectively or Selectively through Key Operation**

See section 4.8.

Explanation

- **Operations That Start Simultaneously with Memory Start**

- Waveform display updating on the trend display.
- Report (/M1, /PM1, /PWR1, and /PWR5 options)
- The computation function (/M1, /PM1, /PWR1, and /PWR5 options) can be configured to start simultaneously with memory start.

See section 9.4.

- **Operations That Stop Simultaneously with Memory Stop**

- Waveform display updating on the trend display.
- Report (/M1, /PM1, /PWR1, and /PWR5 options)
- Computation function (/M1, /PM1, /PWR1, and /PWR5 options): When selected in the procedure described above.

- **Performance While Data Is Being Saved**

If the internal memory or external storage medium is continuously accessed, the following phenomena may occur.

- Files being saved to the external storage medium drop out.
- Accessing the FX through communications takes a long time

In such case, take the following measures.

- If you are creating data files at short intervals consecutively using the event action function, increase the data file save interval.
- If you are creating numerous files in a single directory on the external storage medium, change the destination directory name at approximately every 1000 files.

6.4 Starting/Stopping the Recording and Saving the Measured data

- **Changing Settings and Performing File Operations during Recording (Memory sampling)**

You cannot change the following settings.

- Basic settings
- Input range
- Memory sampling on/off
- Computation channel calculation expressions and constants
- TLOG
- Trend interval
- File save interval
- Timer and match time timer
- VT Ratio, CT Ratio, and low-cut power

6.5 Manually Saving the Measured Data (Manual Sample)

Save the instantaneous values of all channels (excluding those set to Skip or Off) through key operation.

For a description of the function, see section 1.4.

Procedure

1. In the operation mode, press **FUNC**.
The Function menu appears.
2. Press the **Manual sample** soft key.
Manual sampling is executed.

Explanation

- **Number of Manual Sampled Data Set in the Internal Memory**

The number of manual sampled data set in the internal memory is displayed on the memory summary display (see section 1.3)

- **Saving Manual Sampled Data***

- * This is only valid on FXs that have a CF card slot/SD card slot or USB interface (/USB1 option).
- If auto save is **On**, the manual sampled data is saved to the CF card/SD card when you carry out manual sampling.
- If **Auto save** is set to **Off**, save the manual sampled data to the CF card/SD card or USB flash memory (/USB1 option) according to the procedure for manually saving the data (see section 6.4).
- You can save the manual sampled data to the CF card/SD card or USB flash memory (/USB1 option) according to the procedure for manually saving the data (see section 4.8) regardless of the Auto save setting.
- Manual sampled data is saved as a tab-separated text file (see appendix 3).

Note

Even if the FX does not have a CF card slot/SD card slot, you can still execute manual sampling. However, you cannot load data. To load data, the FX must be equipped with a communication interface (/C2, /C3, or /C7 option) or the USB interface (/USB1 option).

6.6 Saving the Screen Image Data (Snapshot)

Save the current screen image data to the CF card/SD card. This operation is called *snapshot*, and the screen image data file is called *snapshot data file*.
For a description of the function, see section 1.4.

Procedure

1. In the operation mode, press **FUNC**.
The Function menu appears.
2. Press the **Snap shot** soft key.
A message indicating that the message "Execution is complete" is displayed, and the snapshot data file is saved to the CF card/SD card.
Image of the soft keys and the message window are not saved.

Note

- If you assign the snapshot function to the USER key, you can take snapshots in all modes (operation mode, setting mode, and basic setting mode). However, error messages will not be saved.
- If the FX does not have a CF card slot/SD card slot, you can execute snapshots, but the operation will not be performed. However, if the FTP transfer operation is enabled (/C7 option), the operation will be performed.

Explanation

- **File Format**
The snapshot data file is in PNG format.
- **File Name**
See section 1.4.

6.7 Managing the Files on the External Storage Medium

This section explains how to display a list of stored files and the amount of available memory, delete files and directories, and format external storage media.

This is only valid on FXs that have a CF card slot/SD card slot or USB interface (/USB1 option).

Procedure

- **Displaying Files, Deleting Files, and Checking Available Memory on the External Storage Medium**

Carry out the procedure below to show the display.

Press **MENU** (to switch to setting mode), and select the **File** tab > **File list, delete** > press the **CF/SD** or **USB** soft key* > and press **DISP/ENTER**.

* When a CF card/SD card and a USB flash memory (/USB1 option) are being used.

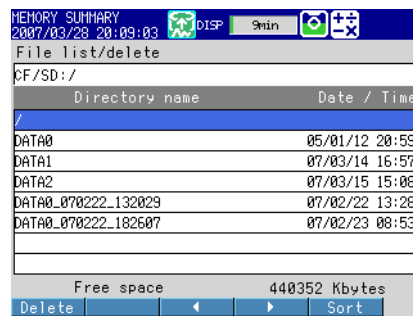

Directory name	Date / Time
/	
DATA0	05/01/12 20:59
DATA1	07/03/14 16:57
DATA2	07/03/15 15:08
DATA0_070222_132029	07/02/22 13:28
DATA0_070222_182607	07/02/23 08:53

Free space 440352 Kbytes

Delete ◀ ▶ Sort

Displaying a List of Files in a Directory and Checking the Free Space

Press the **arrow keys** to select a directory, and press **DISP/ENTER**. The files in the directory are displayed. The root directory is denoted by [/].

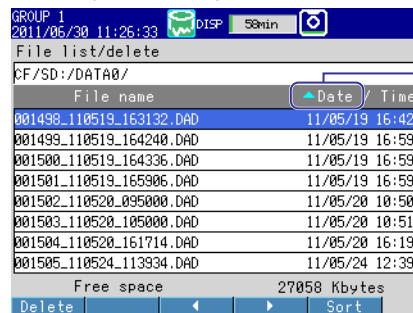

File name	Date / Time
001498_110519_163132.DAD	11/05/19 16:42
001499_110519_164240.DAD	11/05/19 16:59
001500_110519_164336.DAD	11/05/19 16:59
001501_110519_165906.DAD	11/05/19 16:59
001502_110520_095000.DAD	11/05/20 10:50
001503_110520_105000.DAD	11/05/20 10:51
001504_110520_161714.DAD	11/05/20 16:19
001505_110524_113934.DAD	11/05/24 12:39

Free space 27058 Kbytes

Delete ◀ ▶ Sort

▲ : Sorted in order with the oldest timestamp first.

▼ : Sorted in order with the most recent timestamp first.

Sorting Files and Directories

The files and directories can be sorted by the update date/time.

Each time you press the **Sort** soft key, the files and directories are sorted in order from the oldest or the latest update date/time. A mark indicating the sort order is displayed by Date/Time.

If the File Name Does Not Fit in the Display Space

Press the ◀ soft key once to shift the file name to the left by a character.

Press the ▶ soft key once to shift the file name to the right by a character.

6.7 Managing the Files on the External Storage Medium

Deleting a File

Press the **arrow keys** to select the file to be deleted, and press the **Delete** soft key. A confirmation window appears. Select **Yes**, and press **DISP/ENTER**.

The file is deleted.

Deleting a Directory

First, delete all the files in the directory.

Select the directory you want to delete. The rest of the procedure is the same as deleting a file.

Checking the Free Space

The free space on the storage medium is shown at the lower right of the screen.

- **Formatting External Storage Media**

You can format a CF card or a USB flash memory on the FX. Formatting will remove the contents of the external storage medium.

1. Carry out the procedure below to show the display.

Press **MENU** (to switch to setting mode), and select the **File** tab > **Format**. Press the **CF** or **USB** soft key*, and then press **DISP/ENTER**.

* When a CF card and a USB flash memory (/USB1 option) are being used.

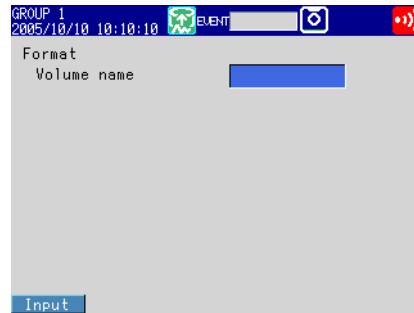

2. Enter the volume name and press **DISP/ENTER**. (Up to 11 characters, **A1**)
A confirmation window opens.
3. Select **Yes** and press **DISP/ENTER**.
The external storage medium will be formatted.

Explanation

- **Format Type**

Size	Type
Storage medium smaller than or equal to 512 MB	FAT16
Storage medium greater than 512 MB	FAT32

Note

Format SD cards on a PC using the SD card formatter software available from the SD Association (<https://www.sdcard.org/home>). You cannot format SD cards on the FX.

6.8 Loading and Displaying Measured Data from External Storage Media

Load the display or event data file saved on the external storage medium and display the waveform. The loaded data is shown on the historical trend display.
For the operations on the historical trend display, see section 4.3.

This is only valid on FXs that have a CF card slot/SD card slot or USB interface (/USB1 option).

Procedure

• Loading a File

1. Carry out the procedure below to show the display.

Press **MENU** (to switch to setting mode), and select the **File** tab > **Load display data** or **Load event data**. Press the **CF/SD** or **USB** soft key*, and then press **DISP/ENTER**.

* When a CF card/SD card and a USB flash memory (/USB1 option) are being used.

Directory name	Date / Time
/	
DATA0	05/01/12 20:59
DATA1	07/03/14 16:57
DATA2	07/03/15 15:00
DATA3	07/03/28 20:09
DATA0_070222_132029	07/02/22 13:28
DATA0_070222_102607	07/02/23 08:53

2. Press the **arrow keys** to select a directory, and press **DISP/ENTER**. The files in the directory are displayed. The root directory is denoted by [/].
3. Press the **arrow keys** to select a file, and press **DISP/ENTER**. The file is loaded, and the waveform is displayed in the historical trend.

File name	Date / Time
000197_SAMPLE050112_210052.DAD	05/01/12 21:00
000198_SAMPLE050112_210944.DAD	05/01/12 21:19
000199_SAMPLE050112_211944.DAD	05/01/12 21:29
000200_SAMPLE050112_212944.DAD	05/01/12 21:39
000201_SAMPLE050112_213944.DAD	05/01/12 21:49
000202_SAMPLE050112_214944.DAD	05/01/12 21:59
000203_SAMPLE050112_215944.DAD	05/01/12 22:09
000204_SAMPLE050112_220944.DAD	05/01/12 22:19

Note

- The extension of display data files is .DAD. The extension of event data files is .DAE.
- For details on how to use the Sort, \triangleright , and \triangleleft soft keys, see section 6.7.

6.9 Saving/Loading the Setup Data

This section explains how to save and load setup data from external storage media.
This is only valid on FXs that have a CF card slot/SD card slot or USB interface (/USB1 option).

Procedure

• Saving the Setup Data

1. Carry out the procedure below to show the display.

Press **MENU** (to switch to setting mode), and select the **File** tab > **Save settings**.
Press the **CF/SD** or **USB soft key**, and then press **DISP/ENTER**.

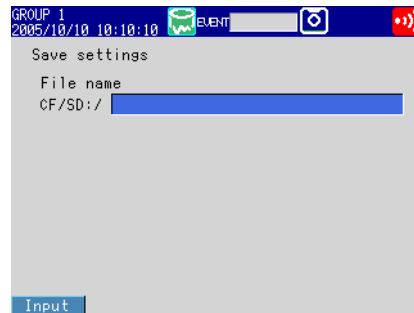

2. Set the file name. (Up to 32 characters, $[Aa\#_]$)
Symbols that can be used: #, %, (,), +, -, ., @, °, and _.
Strings that cannot be used: AUX, CON, PRN, NUL, CLOCK, COM1 to COM9, and LPT1 to LPT9.
To cancel the operation, press **ESC**.
3. Press **DISP/ENTER**.
The setup data is saved.

• Loading the Setup Data for the Setting Mode

1. Carry out the procedure below to show the display.

Press **MENU** (to switch to setting mode), and select the **File** tab > **Load settings**.
Press the **CF/SD** or **USB soft key**, and then press **DISP/ENTER**.

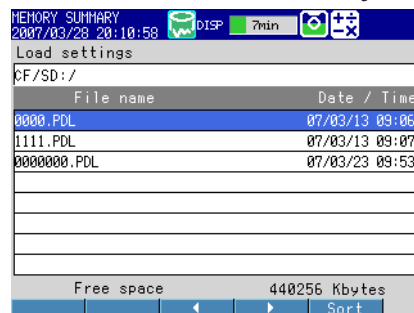

2. Use **DISP/ENTER** and **arrow keys** to select the setup file to be loaded.
* Setup data files are stored in the root directory [/].
To cancel the operation, press **ESC**.
3. Press **DISP/ENTER**.
The setup data is loaded.

Note

For details on how to use the Sort, \triangleright , and \triangleleft keys, see section 6.7.

- **Loading the Setup Data for the Setting Mode and Basic Setting Mode**

1. Carry out the procedure below to show the display.

Press **MENU** (to switch to setting mode), hold down **FUNC** for 3 s (to switch to basic setting mode), and select the **File/Initialize** tab > **Load settings**. Press the **CF/SD** or **USB** soft key*, and then press **DISP/ENTER**.

* When you are using a CF card/SD card and USB flash memory (/USB1 option).

Basic Setting Mode		Ethernet Link
Load settings		
CF/SD:/		
File name	Date / Time	
0000.PDL	07/03/13 09:06	
1111.PDL	07/03/13 09:07	
0000000.PDL	07/03/23 09:53	
Free space 440192 Kbytes		
		Sort

2. Use **DISP/ENTER** and **arrow keys** to select the setup file to be loaded.

* Setup data files are stored in the root directory [/].

To cancel the operation, press **ESC**.

3. Press **DISP/ENTER**.

The setup data is loaded.

Note

For details on how to use the Sort, \triangleright , and \triangleleft keys, see section 6.7.

Explanation

- **Setup Data File**

- The setup data file extension is .PDL.
- The following settings are also saved.
 - Current monitor display conditions
 - Monitor auto recovery registration data

- **Loading Setup Data**

- Only the setup data of the setting mode is loaded in the setting mode. However, settings that contradict the setup data of the basic setting mode are not loaded.
- The monitor display conditions and default display are also loaded.
- If the loaded setup data is not applied, check the error log (see section 4.9).

Note

- While loading the setup data, key operations, operations via communications, and operations via remote input are not available.
- While setup data is being loaded, event action operations are invalid. Any events that occur while setup data is being loaded will be ignored.

7.1 Setting the Event Action Function (Including the remote control function of the /R1 and /PM1 options and the USER key)

A specified action is carried out when an event occurs. This function is called event action. Follow the procedure in this section to also set the remote control function (/R1 and /PM1 options) and the USER key.

For a description of the function, see section 1.6.

Setup Screen

- **Event and Action**

Press **MENU** (to switch to setting mode), and select the **Menu tab > Timer, Event action > Event action.**

GROUP 1	2011/06/16 17:21:49	STOP DISP	1hour	
Logic box number	2			
Event	Remote			
Remote number	1			
Action	DisplayGroupChange			
Group number	1			
Input +1 -1				

- **Timer**

Press **MENU** (to switch to setting mode), and select the **Menu tab > Timer, Event action > Timer.**

- When set to relative time

GROUP 1	2008/12/02 09:31:00	STOP DISP	1hour	
Timer No.	1			
Mode	Relative			
Interval	01:00			
Reset at Math Start	On			
Input +1 -1				

- When set to absolute time

GROUP 1	2008/12/02 09:31:41	STOP DISP	1hour	
Timer No.	1			
Mode	Absolute			
Interval	1h			
Ref.time	0:00			
Input +1 -1				

- **Match Time**

Press **MENU** (to switch to setting mode), and select the **Menu tab > Timer, Event action > Match time timer.**

GROUP 1	2008/12/02 09:32:31	STOP DISP	1hour	
Timer number	1			
Kind	Month			
Day	1			
Hour:Minute	00:00			
Timer action	Repeat			
Input +1 -1				

**7.1 Setting the Event Action Function
(Including the remote control function of the /R1 and /PM1 options and the USER key)**

Setup Items

- **Logic box number**

You can set up to 40.

- **Event action > Event**

The condition to execute the action.

Settings	Description
None	Not use.
Remote	Select the remote control input terminal number.
Relay	Select the alarm output relay number. During Edge operation, a change from deactivated to activated is an event.
Switch	Select the internal switch number. During Edge operation, a change from off to on is an event.
Timer	Select the timer number.
Matchtime	Select the match timer number.
Alarm	During Edge operation, a change from "no alarms are active" to "at least one alarm is active" is an event.
USER key	-

- **Event action > Action**

The action to be executed when an event occurs.

Settings	Description
Memory	-
Start	-
Stop	-
Trigger	Can be specified when the FX is configured to record event data.
AlarmACK	Cannot be specified when the event is set to Relay , Switch , or Alarm .
Math	Can be specified on FXs with the /M1, /PM1, /PWR1, or /PWR5 option.
MathStrt	Start computation. Can be specified on FXs with the /M1, /PM1, /PWR1, or /PWR5 option.
MathStop	Stop computation. Can be specified on FXs with the /M1, /PM1, /PWR1, or /PWR5 option.
Math rst	Reset computation. Can be specified on FXs with the /M1, /PM1, /PWR1, or /PWR5 option.
SaveDisp	Can be specified when the FX is configured to record display data.
SaveEvt	Can be specified when the FX is configured to record event data.
Message	Set the message number to write the message and the destination. Set the message destination to all groups (All) or a group number.
Snap	Snapshot
Rate1/2	Can be specified when the function for switching between the trend interval and the secondary trend interval is enabled.
M.sample	Manual sampling
TimerRst	Cannot be specified when the event is set to Timer .
Group	Specify the number of the group to be displayed.
Flag	Can be specified on FXs with the /M1, /PM1, /PWR1, or /PWR5 option.
Time adj	Can be specified only when the event is set to Remote .
PnlLoad	Can be specified only when the event is set to Remote .

- **Timer**
Timer used by event action. Used also in the TLOG computation of the computation function.
* The timer cannot be changed while memory sampling or computation is in progress.

- **Timer No.**
Up to four timers (1 to 4) can be set.

When Using an Absolute Timer

- **Mode**
Select **Absolute**.
- **Interval**
Select the interval from the available settings between 1min to 24h.
- **Ref.time**
Set the time in the range of hour 0 to hour 23.

When Using a Relative Timer

- **Mode**
Select **Relative**.
- **Interval**
Set the interval in the range of 00:01 (1 min) to 24:00 (24 hours).
- **Reset at Math Start**
On: Resets the timer when computation is started. The resetting of the timer is not considered to be a timeout. Even if the timer is used as an event, the action is not executed.

- **Match Time Timer**
Set the time match condition used in event action.
* The condition cannot be changed while memory sampling or computation is in progress.

- **Timer number**
You can set up to four match time conditions (1 to 4).

- **Kind**

Setting	Description
Day	The condition is matched once a day.
Week	The condition is matched once a week.
Month	The condition is matched once a month.

Set the items with check marks in the following table depending on the Kind setting.

Setup Item	Kind		
	Day	Week	Month
Day	✓		✓
Day of the week		✓	
Hour:Minute	✓	✓	✓

- **Month**
Specify the month.
- **Day**
Set the day.
- **Day of the week**
Set the day of the week.
- **Hour:Minute**
Set the time in the range of 00:00 to 23:59.

- **Timer action**

Settings	Description
Single	Executes the action once when the condition is met.
Repeat	Executes the action at every specified time.

7.1 Setting the Event Action Function (Including the remote control function of the /R1 and /PM1 options and the USER key)

Procedure

- **Resetting the Relative Timer**
 1. In the operation mode, press **FUNC**.
The Function menu appears.
 2. Press the **Timer reset** soft key.
 3. Press the **soft key** corresponding to timer you want to reset. Select **All** to reset all timers.
The relative timer is reset.

Explanation

- **Resetting the Relative Timer**

Restarts the timer.

 - The resetting of the timer is considered to be a timeout. (If the timer is used as an event, the action is executed.)
 - If you use a timer with the TLOG computation function (/M1, /PM1, /PWR1, and /PWR5 options), and have specified the resetting at each interval for the computed value, the TLOG computed results will be reset.

7.2 Setup Examples of Event Action

Example 1: Starting/Stopping the Memory Sampling through Remote Control (/R1 Option)

Starts/Stops the memory sampling when a signal is applied to remote control input terminal 2. Use logic box number 1.

- **Setup Screen and Setup Items**

Press **MENU** (to switch to setting mode), and select the **Menu** tab > **Timer, Event action** > **Event action**.

Logic box number	1
Event	Remote
Remote number	2
Action	MemoryStart/Stop

<Operation>

If the input to the remote control input terminal 2 is turned ON when memory sampling is stopped, memory sampling starts. If the remote control input is turned OFF when memory sampling is in progress, memory sampling stops.

Example 2: Writing a Message When an Alarm Occurs

Write the message "Channel 1 Alarm" to group 1 when an alarm occurs on channel 1. Use logic box number 2.

- **Setup Screen and Setup Items**

Press **MENU** (to switch to setting mode), and select the **Menu** tab > **Timer, Event action** > **Event action**.

Logic box number	2
Event	Switch
Switch No.	503
Action	Message
Message No.	4
Write to	Select
Group number	1

<Other Settings>

- Set an alarm to channel 1 and output to internal switch 3.
- Register "Channel 1 alarm" in message number 4.

For the procedure to set the alarm, see section 3.7.

For the procedure to set the message, see section 5.4.

Example 3: Saving the Data Every Day at Hour 17

Save the recorded data to the CF card/SD card every day at hour 17. Use logic box number 3. Use match time condition 1.

- **Setup Screen and Setup Items**

Logic box number 3

Press **MENU** (to switch to setting mode), and select the **Menu** tab > **Timer, Event action** > **Event action**.

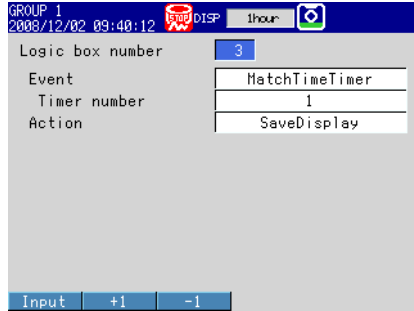

Match Time Condition

Press **MENU** (to switch to setting mode), and select the **Menu** tab > **Timer, Event action** > **Match time timer**.

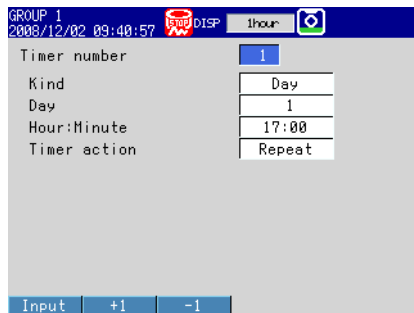

<Other Settings>

Set the display data to be saved automatically. Set the file save interval to **1day** or longer. If a file save interval shorter than **1day** is specified, the data is also saved at the file save interval.

For the procedure to set the recording conditions of the display data, see section 6.1.

Example 4: Releasing the Alarm Output Using the USER Key (Alarm Acknowledge Operation)

Release the activated alarm output by pressing the USER key. Use logic box number 4.

- **Setup Screen and Setup Items**

Press **MENU** (to switch to setting mode), and select the **Menu tab > Timer, Event action > Event action**.

Field	Value
Logic box number	4
Event	UserKey
Action	AlarmACK

<Operation>

Press the USER key to release the activated alarm indication and relay output.

<Related Settings>

Set the alarm indication and alarm output relay operation to **Hold**.

For the procedure to set the alarm indication operation and alarm output relay operation, see section 3.5.

8.1 Disabling the Key Operation (Key Lock Function)

Disable the key operation.

For a description of the function, see section 1.7.

Setup Screen

- **Selecting the Key Lock Function**

Press **MENU** (to switch to setting mode), hold down **FUNC** for 3 s (to switch to basic setting mode), and select the **Environment** tab > **Security, Media save**.

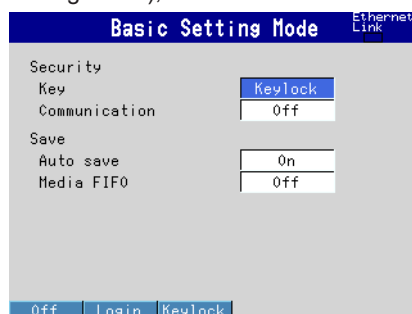

- **Key Operation to Be Disabled**

Press **MENU** (to switch to setting mode), hold down **FUNC** for 3 s (to switch to basic setting mode), and select the **Menu** tab > **Keylock** > **Key action, Media*** or **Action of Function**.

* On FXs that do not have a CF card slot/SD card slot or USB interface (/USB1 option), the sub menu item is “Key action.” In addition, the “Media/USB” group of setup items is not displayed.

- **Key action, Media**

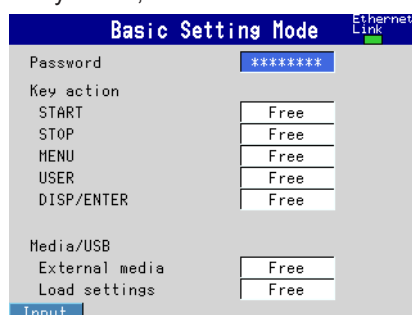

- **Action of Function**

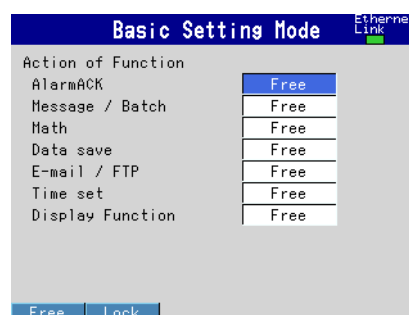

Setup Items

- **Security > Key**

Select **Keylock**.

Settings	Description
Keylock	Enables the key lock function. The Keylock item is displayed in the basic setting mode menu.
Login	Enables the login function. See section 8.2.

- **Keylock > Password**

The password used to release the key lock. (Up to 8 characters, $\overline{Aa\#1}$)
The password is displayed as “*****”.

- **Key action, Media/USB, or Action of Function**

Select whether to lock each item.

Settings	Description
Free	Key lock not applied.
Lock	Disables the operation.

8.1 Disabling the Key Operation (Key Lock Function)

Procedure

- **Locking the Keys**

1. In the operation mode, press **FUNC**.
The Function menu appears.
2. Press the **Keylock** soft key.
The key lock is activated. The key lock icon appears in the status display section.

- **Releasing the Key Lock**

1. In the operation mode, press **FUNC**.
The Function menu appears.
2. Press the **Keylock** soft key.
A window appears for you to enter the password.

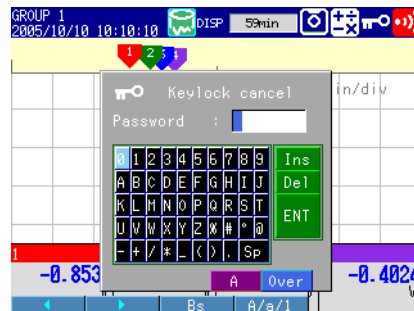

3. Enter the password and press **DISP/ENTER**.
The key lock is released. The key lock icon in the status display section disappears.
* The password that you entered is displayed as "*****."

8.2 Enabling Only Registered Users to Operate the FX (Login Function)

With the login function, only registered users can operate the FX.
For a description of the function, see section 1.7.

Setup Screen

- **Login Function**

Press **MENU** (to switch to setting mode), hold down **FUNC** for 3 s (to switch to basic setting mode), and select the **Environment** tab > **Security, Media save**.*

* On FXs that do not have a CF card slot/SD card slot, the sub menu item is "Security." In addition, the "Save" group of setup items is not displayed.

On FXs that do not have the Ethernet communication interface (/C7 option), the "Communication" setup item in the following figure is not displayed.

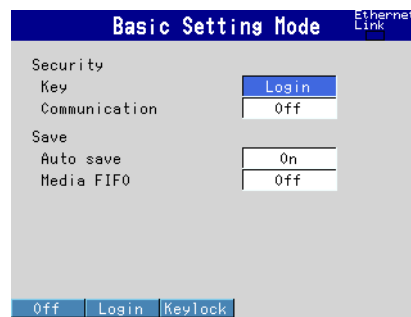

- **Logout Method**

Press **MENU** (to switch to setting mode), hold down **FUNC** for 3 s (to switch to basic setting mode), and select the **Menu** tab > **Login** > **Basic settings**.

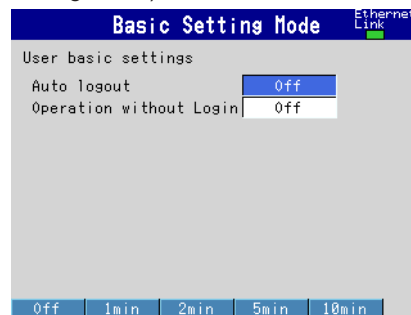

- **Registering Administrators**

Press **MENU** (to switch to setting mode), hold down **FUNC** for 3 s (to switch to basic setting mode), and select the **Menu** tab > **Login** > **Admin settings**.

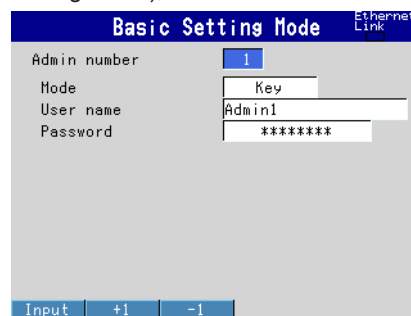

8.2 Enabling Only Registered Users to Operate the FX (Login Function)

- **Registering Users**

Press **MENU** (to switch to setting mode), hold down **FUNC** for 3 s (to switch to basic setting mode), and select the **Menu** tab > **Login** > **User settings**.

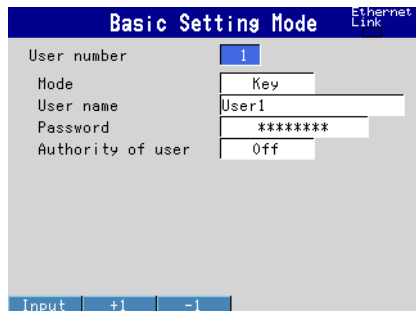

- **User Privileges**

Press **MENU** (to switch to setting mode), hold down **FUNC** for 3 s (to switch to basic setting mode), and select the **Menu** tab > **Login** > **Authority of user** > **Key action**, **Media**^{*} or **Action of Function**.

* On FXs that do not have a CF card slot/SD card slot and USB interface (/USB1 option), the sub menu item is “Key action.” In addition, the “Media/USB” group of setup items in the following figure is not displayed.

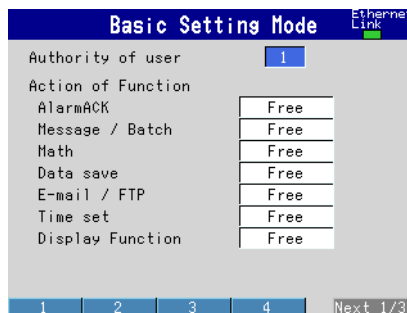
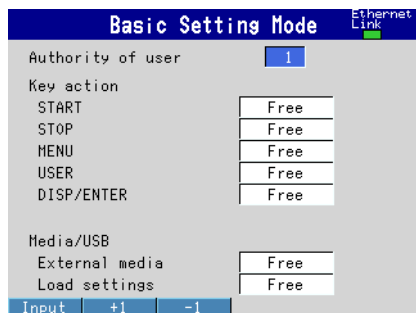

Setup Items

You can configure the login function separately for login through keys and login through communication commands (/C7 option).

- **Security > Key**

Select **Login**.

Settings	Description
Login	Enables only registered users to operate the FX using keys. The Login item is displayed in the basic setting mode menu.
Keylock	Enables the key lock function. See section 8.1.
Off	Disables the security functions.

- **Security > Communication (/C7 option)**

Settings	Description
Login	Enables only registered users to operate the FX via communications. The Login item is displayed in the basic setting mode menu.
Off	Disables the security functions.

- **User basic settings > Auto logout**

Settings	Description
Off	Does not log out until the logout operation is executed.
1min to 10min	Automatically logs out when there is no key operation for a specified time.

- **User basic settings > Operation without login**

Sets the operation that the user can carry out when logged out.

Settings	Description
Off	Only login operation is available.
Display	Allows the user to switch the operation screen in addition to the login operation.

- **Admin number**

Up to five administrators can be registered. Be sure to register at least one administrator. At least one administrator must be registered to use the login function.

- **Admin settings > Mode**

The available settings vary depending on the **Security** setting.

Settings	Description
Off	Not register.
Key	Log into the FX using keys.
Comm*	Log into the FX using communication commands.
Web*	Log into the operator page and monitor page of the FX using a Web browser.
Key+Comm*	Log into the FX using keys and using communication commands.

* Ethernet communication (/C7 option)

- **Admin settings > User name**

Set the user name. (Up to 20 characters, [Aa#1])

- You cannot register user names that are already registered.
- You cannot register “quit” or a user name containing all spaces.

- **Admin settings > Password**

Set the password (up to 8 characters, [Aa#1])

Unregistered password is displayed as “????????”. An entered password is displayed as “*****”.

- You cannot register “quit” or a password containing all spaces.
- Default password is “space (blank).”

- **User number**

Up to 30 users can be registered.

- **User settings > Mode**

The available settings vary depending on the **Security** setting.

Settings	Description
Off	Not register.
Key	Log into the FX using keys.
Comm*	Log into the FX using communication commands.
Web*	Log into the monitor page of the FX using a Web browser.
Key+Comm*	Log into the FX using keys and using communication commands.

* Ethernet communication (/C7 option)

- **User settings > User name, Password**

See the explanation for the administrator user name and password.

- **Authority of user**

Settings	Description
Off	No limitations on the operation.
1 to 10	Registration number of the operation limitation.

- **Authority of user > Key action, Media/USB, Action of Function**

Set “Authority of user” to a number between 1 and 10.

See section 8.1.

8.3 Logging in and Logging Out

This section explains the procedure to log into the FX using keys. For the procedure for using communication commands to log into the FX, see the *Communication Interface User's Manual*, IM 04L21B01-17EN.

Procedure

• Logging In

1. In the operation mode, press **FUNC**.
A list of registered user names appears.

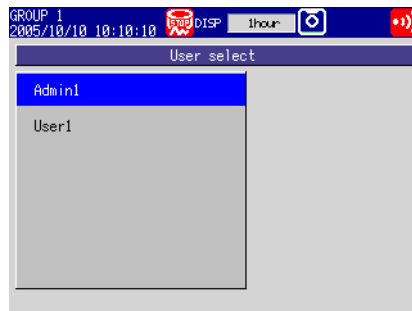

2. Press the **arrow keys** to select a user name, and press **DISP/ENTER**.
A window appears for you to enter the password.

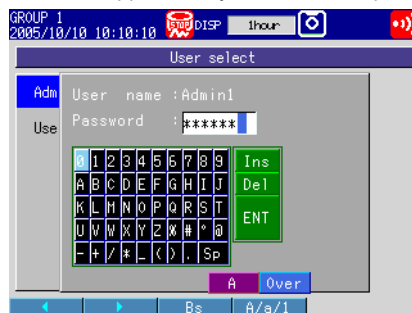

3. Enter the password* and press **DISP/ENTER**.
The FX is ready to be operated using keys. The name of the user that is logged in is displayed in the status display section.
* The password that you enter is displayed as "*****."

• Logging Out Using Keys

1. In the operation mode, press **FUNC**.
The Function menu appears.
2. Press the **Logout** soft key.
You are logged out from the FX. The user name in the status indication section disappears.

Auto Logout

If auto logout is enabled, you are automatically logged out if there is no key operation for a specified time.

- **Changing the Password**

- **Using Keys**

1. In the operation mode, press **FUNC**.
The Function menu appears.
2. Press the **Password change** soft key.
A window appears for you to enter the current password.
3. Enter the current password, select **ENT**, and press **DISP/ENTER**.
A window appears for you to enter the new password.
4. Enter the new password, select **ENT**, and press **DISP/ENTER**.
A window appears for you to enter the new password again.
5. Enter the new password, select **ENT**, and press **DISP/ENTER**.
The window closes, and the new password is activated.

9.1 Setting the Expression, Measurement Range, Alarm, Tag, and Data Storage on Computation Channels

This section explains how to set a computation channel's expression, measurement range, tag, alarm, and recording On/Off. You cannot set expressions or constants while memory sampling or computation is in progress.

For a description of the function, see section 1.8.

For the power measurement (/PWR1 or /PWR5 option) expression, see section 3.12.

Setup Screen

- Expression and Alarm**

Press **MENU** (to switch to setting mode), and select the **Menu** tab > **Math channel** > **Expression, Alarm**.

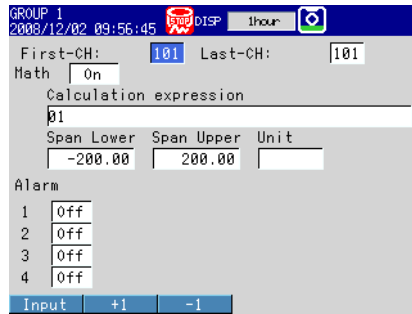

- Constants Used in Expressions**

Press **MENU** (to switch to setting mode), and select the **Menu** tab > **Math channel** > **Constant**.

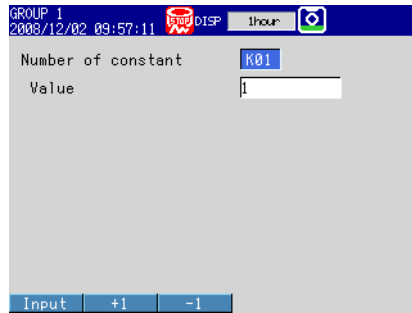

- Tag, Memory Sampling On/Off, and Alarm Delay Time of Computation Channels**

Press **MENU** (to switch to setting mode), and select the **Menu** tab > **Math channel** > **Tag, Memory, Delay**.

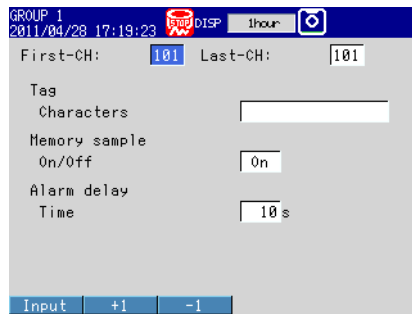

9.1 Setting the Expression, Measurement Range, Alarm, Tag, and Data Storage on Computation Channels

- **Conditions of TLOG Computation and Rolling Average**

Press **MENU** (to switch to setting mode), and select the **Menu** tab > **Math channel** > **TLOG, Rolling average**.

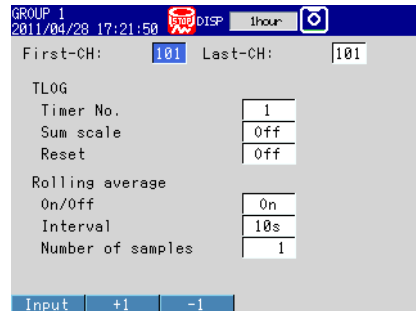

- **Display for Computation Errors and Handling of Overflow Data in Statistical Computation**

Press **MENU** (to switch to setting mode), hold down **FUNC** for 3 s (to switch to basic setting mode), and select the **Environment** tab > **Math**.

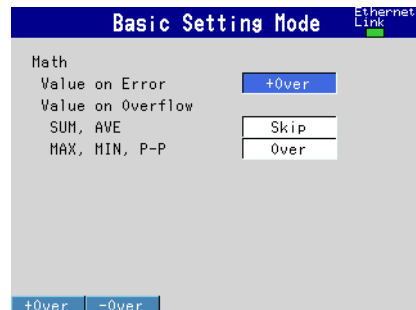

Setup Items

- **First-CH/Last-CH**

Set the target channels.

- **Expression/Span**

- **Math On/Off**

Select **On** for channels to be used.

- **Calculation expression**

Enter the expression using up to 120 characters.

Pressing the **Input** soft key displays a window used to enter the expression.

Press the **M1/M2** soft key* to switch between a screen used to enter values and characters and a screen used to enter operators and functions. Use **soft keys**, **arrow keys**, and **DISP/ENTER** to enter an expression.

* On FXs with the power monitor function (/PWR1 or /PWR5 option), there is also an M3 soft key.

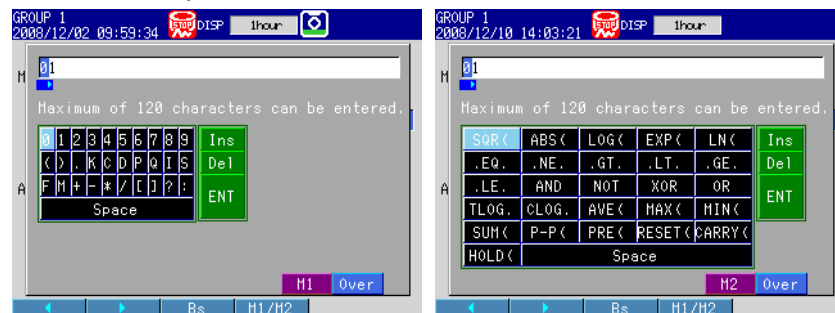

For details on how to write expressions, see section 9.2.

Note

You cannot use both a USB keyboard (/USB1 option) and the FX keys at the same time to enter expressions. If you press a soft key or other FX key while you are using a USB keyboard to enter an expression, the expression that you have entered up to that point will be cleared.

9.1 Setting the Expression, Measurement Range, Alarm, Tag, and Data Storage on Computation Channels

- **Span_L, Span_U**

Set the measurement range.

Selectable range of values: -9999999 to 99999999

Selectable decimal places: X.XXXX, XX.XXX, XXX.XX, XXXX.X

- **Unit**

Set the unit of the computed value (Up to 6 characters, $\boxed{\text{Aa}\#\text{1}}$).

- **Alarm**

The available alarm types are high limit alarm, low limit alarm, delay high limit alarm, and delay low limit alarm.

The range of alarm values is as follows:

Type	Value
H, L, T, t	Within -9999999 to 99999999 excluding the decimal point

For details on setting alarms, see section 3.7.

* If the Math On/Off or calculation expression is changed, the alarms for that channel are turned **Off**.

- **Alarm delay > Time**

Set the alarm delay time using an integer in the range of 1 to 3600 s.

- **Tag > Characters**

Set the tag using up to 16 characters: $\boxed{\text{Aa}\#\text{1}}$

- **Constant**

- **Number of constant**

Select the constant (K01 to K60) to set.

- **Value**

The selectable range is as follows:

-9.9999E+29 to -1.0000E-30, 0, 1.0000E-30 to 9.9999E+29

The number of significant digits of a constant is five. When specifying the constant using exponential notation, set the mantissa less than or equal to 5 digits and the exponent less than or equal to 2 digits.

- **TLOG**

- **Timer No.**

Select the timer number to use.

For details on setting the timer, see section 7.1.

- **Sum scale**

Set the sum scale to **/s** to **/h** to match the unit of the measured value.

Example: If the unit of the measured value is "m³/min," select **/min**.

Off: Sums as-is the measured data per scan interval.

- **Reset**

To reset the TLOG computed value at each interval, select **On**.

9.1 Setting the Expression, Measurement Range, Alarm, Tag, and Data Storage on Computation Channels

- **Rolling average**
 - **On/Off**

To take the rolling average of the measured results, select **On**.
 - **Interval**

Select the sampling interval when taking the rolling average from the following: The sampling interval takes on a value that is an integer multiple of the scan interval. For example, if the sampling interval is set to 5 s when the scan interval is 2 s, the actual sampling interval is 6 s.
 - **Number of samples**

Set the number of samples for the rolling average using an integer between 1 and 1500.

The rolling average time is equal to the sampling interval × the number of samples.

Note

- If the number of data points in the moving average has not reached the specified number of samples immediately after computation is started, the average of the available data is calculated.
- Computation error data is excluded from the rolling average computation.
- If the computed data exceeds the upper or lower limit, the data is clipped at the upper or lower limit, and the rolling average is computed. The upper and lower limit is “±100000000” excluding the decimal point. The decimal place is the same as that of the span lower limit.

- **Memory sample > On/Off**

Select **On** to record the computed data of the target channels.

Settings	Description
On	Computed data is recorded. Waveforms are displayed on the trend display.
Off	Computed data is not recorded. Even when registered in a display group, waveforms are not displayed in the trend display.

- **Math**

- **Value on Error**

Specify whether to set the display for a computation error to **+Over** or **-Over**.

- **Value on Overflow > SUM, AVE**

Specify how to handle overflow data when it is detected in the SUM or AVE computation of TLOG or CLOG. This setting is also applied to report generation.

Settings	Description
Error	Sets the computed result to computation error.
Skip	Discards the overflow data and continues the computation.
Limit	Uses a limit value in place of the overflow data and continues the computation.

- **Value on Overflow > MAX, MIN, P-P**

Specify how to handle overflow data when it is detected in the MAX, MIN, or P-P computation of TLOG or CLOG. This setting is also applied to report generation.

Settings	Description
Over	Uses the overflow data as-is.
Skip	Discards the overflow data and continues the computation.

9.2 Writing Expressions

This section explains the meaning and how to write expressions.

Common Items

Follow the rules below when writing expressions.

- Use up to 120 characters to write expressions.
- The precedence of computing terms can be specified using parentheses.
- Specify the channels in the expression using channel numbers.

Example: 1, 12, and 101

Do not include channels that are set to Log scale (/LG1 option) in a computation channel expression. If you include these channels, an error will be returned as the measured result.

See section 3.13, "Using the Log Scale to Perform Measurements."

- The one-digit number of constants (K), communication input data (C), remote input terminal status (D), pulse input (P, Q), internal switch (S), alarm output relay status (I), and flag (F) in the expression can be denoted as in "01" and "1."

Example: K01, K1, C01, C1, D01, D1, P01, P1, Q01, Q1, S01, S1, I01, I1, F01, and F1.

- The data of the previous scan is used in the computation for its own channel number and channel numbers greater than its own channel number in the expression.
- Write special computations (HOLD, RESET, and CARRY) and conditional expressions at the beginning of expressions.
- You can specify the power measurement elements: active power, regenerative power, reactive power (lead and lag), apparent power, voltage, current, frequency, and power factor (/PWR1 or /PWR5 option)
See section 3.12, "Measuring Power."

9.2 Writing Expressions

Order of Precedence in Computations

The order of precedence of computation in expressions is as follows:

Type	Computing Element
Function	(high order of precedence) ABS(), SQR(), LOG(), LN(), EXP(), TLOG.MAX(), TLOG.MIN(), TLOG.AVE(), TLOG.SUM(), TLOG.P-P(), CLOG.MAX(), CLOG.MIN(), CLOG.AVE(), CLOG.SUM(), CLOG.P-P()
Special computation and conditional expression	PRE, HOLD, RESET, CARRY, [a?b:c]
Power	**
Logical negation	NOT
Multiplication and division	*, /
Addition and subtraction	+, -
Greater than and less than	.GT., .LT., GE., LE.
Equal and not equal	.EQ., .NE.
Logical product	AND
Logical sum and exclusive logical sum	OR, XOR
	(low order of precedence)

Limitations

The following limitations exist in writing expressions.

Type	Limitations
TLOG computation	A computing element cannot be written inside the parentheses. Only one TLOG computation can be specified in a single expression.
CLOG computation	Number of channels that can be written in the parentheses is 30 channels or less. A computing element cannot be written inside the parentheses. Only one CLOG computation can be specified in a single expression.
PRE	A computing element cannot be written inside the parentheses.
HOLD(a):b	Can only be written at the beginning of an expression. Only one HOLD computation can be specified in a single expression.
RESET(a):b	Can only be written at the beginning of an expression. Only one RESET computation can be specified in a single expression.
CARRY(a):b	Can only be written at the beginning of an expression. Only one CARRY computation can be specified in a single expression. Only TLOG.SUM can be written in "b."
Conditional equation [a?b:c]	RESET, CARRY, or HOLD cannot be written to "a," "b," or "c." Other computing elements cannot be combined (example: [a?b:c]+001). However, conditional equations can be specified for a, b, and c.

Four Arithmetic Operation

Expression Example

- Addition 001+002
(Determines the sum of the measured values of channel 1 and channel 2.)
- Subtraction 001-002
(Determines the difference of the measured values of channel 1 and channel 2.)
- Multiplication 001*K03
(Multiplies constant K03 to the measured value of channel 1.)
- Division 001/K02
(Divides the measured value of channel 1 by constant K02.)

Power and Other Computations

Expression Example

- Power 001**002
(Determines the measured value of channel 1 to the power of the measured value of channel 2.)
- Square root SQR(002)
(Determines the square root of the measured value of channel 2.)
- Absolute value ABS(002)
(Determines the absolute value of the measured value of channel 2.)
- Common logarithm LOG(001)
(Determines the common logarithm (\log_{10}) of the measured value of channel 1.)
- Natural logarithm LN(001)
(Determines the natural logarithm of the measured value of channel 1.)
- Exponent EXP(001)
(Determines e to the power of the measured value of channel 1.)

Relational Computation

Expression Example

002.LT.003

If the measured value of channel 2 is less than the measured value of channel 3, the computed result is "1." Otherwise, the result is "0."

002.GT.003

If the measured value of channel 2 is greater than the measured value of channel 3, the computed result is "1." Otherwise, the result is "0."

002.EQ.003

If the measured value of channel 2 is equal to the measured value of channel 3, the computed result is "1." Otherwise, the result is "0."

002.NE.003

If the measured value of channel 2 is not equal to the measured value of channel 3, the computed result is "1." Otherwise, the result is "0."

002.GE.003

If the measured value of channel 2 is greater than or equal to the measured value of channel 3, the computed result is "1." Otherwise, the result is "0."

002.LE.003

If the measured value of channel 2 is less than or equal to the measured value of channel 3, the computed result is "1." Otherwise, the result is "0."

Logical Computation

Checks whether the two data values, e1 and e2 (e1 only for NOT), are zeroes or non-zeroes, and computes according to the conditions.

AND

Logical product

(Syntax) e1ANDe2

(Condition) If the two data values e1 and e2 are both non-zeroes, the computed result is "1." Otherwise, it is "0."

(Explanation) e1 = 0, e2 = 0 → e1ANDe2 = 0
e1 ≠ 0, e2 = 0 → e1ANDe2 = 0
e1 = 0, e2 ≠ 0 → e1ANDe2 = 0
e1 ≠ 0, e2 ≠ 0 → e1ANDe2 = 1

OR

Logical sum

(Syntax) e1ORe2

(Condition) If the two data values e1 and e2 are both zeroes, the computed result is "0." Otherwise, it is "1."

(Explanation) e1 = 0, e2 = 0 → e1ORe2 = 0
e1 ≠ 0, e2 = 0 → e1ORe2 = 1
e1 = 0, e2 ≠ 0 → e1ORe2 = 1
e1 ≠ 0, e2 ≠ 0 → e1ORe2 = 1

XOR

Exclusive OR

(Syntax) e1XORe2

(Condition) If the two data values e1 and e2 are zero and non-zero or non-zero and zero, the computed result is "1." Otherwise, it is "0."

(Explanation) e1 = 0, e2 = 0 → e1XORe2 = 0
e1 ≠ 0, e2 = 0 → e1XORe2 = 1
e1 = 0, e2 ≠ 0 → e1XORe2 = 1
e1 ≠ 0, e2 ≠ 0 → e1XORe2 = 0

NOT

Logical negation

(Syntax) NOTe1

(Condition) The result is the inverse of the status of data e1 (zero or non-zero).

(Explanation) e1 = 0 → NOTe1 = 1
e1 ≠ 0 → NOTe1 = 0

Expression Example

01-02OR03.GT.04

Determines the OR of the computed results of "01-02" and "03.GT.04".

TLOG Computation

In the explanation below, an expression containing a computing element, an internal switch (S), a relay (I), a flag (F), and power measurement elements—voltage, current, frequency, and power factor—cannot be written in e1. In addition, only one TLOG computation can be specified in a single computing equation.

TLOG.MAX()

Maximum value

(Syntax) TLOG.MAX(e1)

(Condition) Determines the maximum value of channel e1.

TLOG.MIN()

Minimum value

(Syntax) TLOG.MIN(e1)

(Condition) Determines the minimum value of channel e1.

TLOG.AVE()

Average value

(Syntax) TLOG.AVE(e1)

(Condition) Determines the average value of channel e1.

TLOG.SUM()

Sum value

(Syntax) TLOG.SUM(e1)

(Condition) Determines the sum of channel e1.

TLOG.P-P()

Maximum - minimum value

(Syntax) TLOG.P-P(e1)

(Condition) Determines the maximum - minimum value of channel e1.

Expression Example

TLOG.MAX(01)+K01*SQR(02)

Examples of Equations That Are Not Allowed

TLOG.AVE(01)+TLOG.AVE(02)

Reason: TLOG appears twice in one equation.

TLOG.AVE(ABS(01))

Reason: A computing element is used inside the parentheses.

CLOG Computation

Only data of measurement channels and computation channels can be used in the CLOG computation. Up to 30 channels can be written in the parentheses.

In the explanation below, an expression containing a computing element cannot be written to e1, etc. In addition, only one CLOG computation can be specified in a single computing equation.

CLOG.SUM()

Sum value

(Syntax) CLOG.SUM(e1.e2.e4-e6)

(Condition) Determines the sum of the data of channels e1, e2, e4, e5, and e6 that are measured at the same time.

CLOG.MAX()

Maximum value

(Syntax) CLOG.MAX(e1.e2.e4-e6)

(Condition) Determines the maximum value among the data of channels e1, e2, e4, e5, and e6 that are measured at the same time.

CLOG.MIN()

Minimum value

(Syntax) CLOG.MIN(e1.e2.e5.e7)

(Condition) Determines the minimum value among the data of channels e1, e2, e5, and e7 that are measured at the same time.

CLOG.AVE()

Average value

(Syntax) CLOG.AVE(e1-e6)

(Condition) Determines the average value among the data of channels e1 to e6 that are measured at the same time.

CLOG.P-P()

Maximum - minimum value

(Syntax) CLOG.P-P(e1.e2.e5.e7)

(Condition) Determines the difference between the maximum and minimum values among the data of channels e1, e2, e5, and e7 that are measured at the same time.

Expression Example

CLOG.MAX(001.002.104-106)+K01*SQR(002)

Examples of Equations That Are Not Allowed

CLOG.AVE(001.003.005)+CLOG.AVE(002.004.006)

Reason: CLOG appears twice in one equation.

CLOG.AVE(001.ABS(001))

Reason: A computing element is used inside the parentheses.

Special Computation

PRE ()

(Syntax) PRE(e1)
(Condition) Determines the previous value of e1.

HOLD(a):b

(Syntax) HOLD(a):b
(Condition) When a is zero, b is carried out to derive the computed value. Otherwise, the previous computed value is held.

RESET(a):b

(Syntax) RESET(a):b
(Condition) When a is zero, b is carried out to derive the computed value. Otherwise, the previous computed value of b is reset, and b is carried out to derive the computed value.

CARRY(a):b

(Syntax) CARRY(a):b
(Condition) Only TLOG.SUM can be specified for b. If the computed value X of b is less than a, the computed result is X. If X is greater than or equal to a, the computed result is the excess (X – a).
(Description) When a value such as the flow rate is summed and the threshold value is reached or exceeded, the sum value is reset while carrying over the amount that exceeded the threshold value.

Expression Example

Expression that sums the values of channel 1 and resets the value when it reaches or exceeds 10000

K01 = 10000
CARRY(K01):TLOG.SUM(001)

Examples of Equations That Are Not Allowed

002+HOLD(K01):TLOG.SUM(001)
Reason: HOLD is not at the beginning of the expression.

RESET(101.GT.K01):TLOG.SUM(001)+RESET(101.GT.K01):002
Reason: RESET appears twice in one equation.

Conditional Expression

[a?b:c]

(Syntax) [001.GT.K01?002:003]
(Condition) If the measured value of channel 1 is greater than constant K01, the computed result is the measured value of channel 2. Otherwise, the computed result is the measured value of channel 3.

Examples of Equations That Are Not Allowed

[001.GT.K01?002:003]*K02
Reason: Used in combination with another computing element.

Nested Conditional Expressions

A conditional expression can be written to Expression₁, Expression₂, and Expression₃ in the equation [Expression₁?Expression₂:Expression₃]. For example, the following expression is allowed:

[Equation₁?[Equation₂₋₁?Equation₂₋₂:Equation₂₋₃]:[Equation₃₋₁?Equation₃₋₂:Equation₃₋₃]]
Expressions can be nested as long as the number of characters of the expression does not exceed 120 characters.

9.3 Displaying the Computation Channels

Computation channels can be assigned to groups and displayed in a similar manner to measurement channels.

For a description of the function, see section 1.8.

Setup Screen

- **Color**

Press **MENU** (to switch to setting mode), and select the **Menu tab > Math channel > Color**.

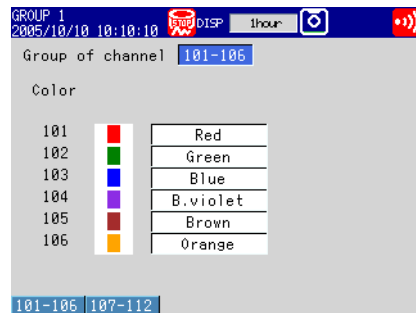

- **Zone Display and Scale Display**

Press **MENU** (to switch to setting mode), and select the **Menu tab > Math channel > Zone, Scale**.

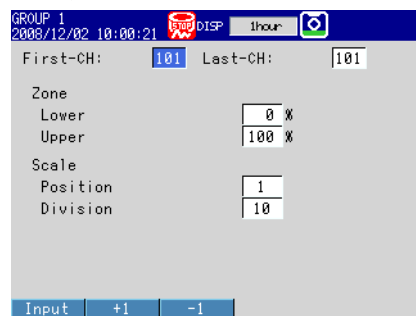

- **Bar Graph Display**

Press **MENU** (to switch to setting mode), and select the **Menu tab > Math channel > Bar**.

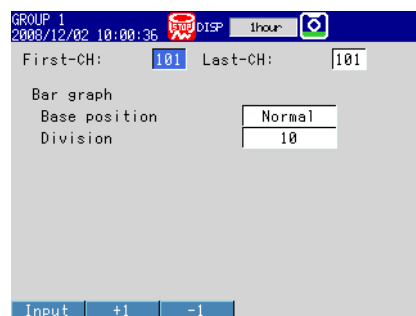

- **Partial Expanded Display**

Press **MENU** (to switch to setting mode), and select the **Menu** tab > **Math channel** > **Partial**.

- * The Partial command appears in the menu if you set Partial to On in basic setting mode under View, Message on the Environment tab.

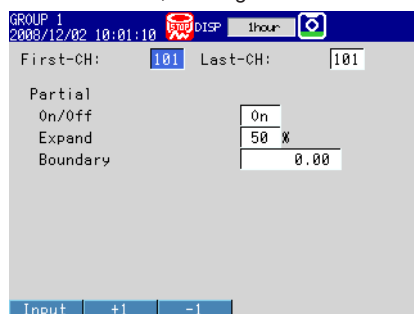

- **Alarm Marks**

Press **MENU** (to switch to setting mode), and select the **Menu** tab > **Math channel** > **Alarm mark**.



- **Color Scale Band**

Press **MENU** (to switch to setting mode), and select the **Menu** tab > **Math channel** > **Color scale band**.

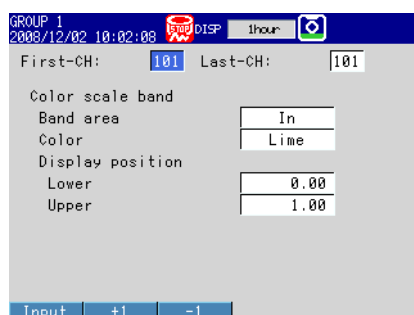

Setup Items

- **Group of channel, First-CH, and Last-CH**
Select the target channel range.
- **Color**
See section 5.5.
- **Zone**
See section 5.6.
- **Partial**
See section 5.9.
- **Bar graph**
See section 5.11.
- **Scale**
See section 5.7.
- **Alarm mark color and Color scale band**
See section 5.8.

9.4 Starting/Stopping Computation, Resetting Computation, and Releasing Computation Data Dropout Display

Setup Screen

- **Action Taken When the START Key Is Pressed**

Press **MENU** (to switch to setting mode), and select the **Menu** tab > **Math channel** > **Math start action**.

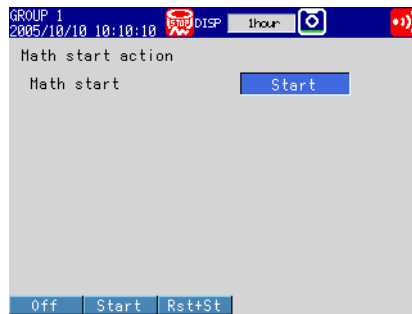

Setup Items

- **Math start action > Math start**

Settings	Description
Off	Does not start the computation even when the START key is pressed.
Start	Starts the computation when the START key is pressed.
Rst+St	Resets the computed result up to then and starts the computation when the START key is pressed.

Procedure

- **Starting the Computation**

- **Starting the Computation Simultaneously with the Memory Sampling**

Press **START**. Computation starts simultaneously with the start of the memory sampling. The computation icon appears in the status display section.

* **Math start** must be set to **Start** or **Rst+St**.

- **Starting Only the Computation**

1. In the operation mode, press **FUNC**.

The Function menu appears.

2. Press the **Math start** soft key.

Computation starts, and the computation icon is displayed in the status display section.

- **Stopping the Computation**
 - **Stopping the Computation Simultaneously with the Memory Sampling**

1. Press **STOP**.

A confirmation dialog box appears.

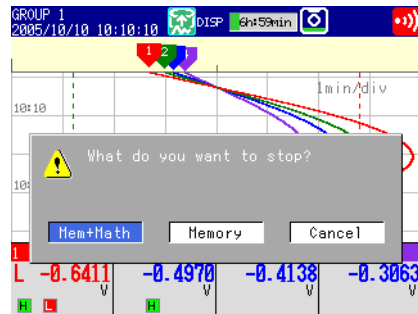

2. Select **Mem+Math** and press **DISP/ENTER**.

The memory sampling and computation stop, and the computation icon in the status display section disappears.

- **Stopping Only the Computation**

1. In the operation mode, press **FUNC**.

The Function menu appears.

2. Press the **Math stop** soft key.

The computation stops, and the computation icon in the status display section disappears.

Note

When the computation is stopped, the computed data of the computation channel is held at the value that existed immediately before the computation is stopped. When memory sampling is in progress, the held value is recorded.

- **Resetting the Computed Results on all Computation Channels**

1. In the operation mode, press **FUNC**.

The Function menu appears.

2. Press the **Math reset** soft key.

The computed results of all computation channels are reset.

- **Releasing the Computation Data Dropout Display**

This operation can be carried out when a computation data dropout occurs. When a computation data dropout occurs, the computation icon turns yellow.

1. In the operation mode, press **FUNC**.

The Function menu appears.

2. Press the **Math ACK** soft key.

The computation icon returns to white.

Math ACK is displayed on the Function menu only when a computation data dropout occurs.

Note

A computation data dropout occurs when the computation process cannot be completed within the scan interval. If computation data dropout occurs frequently, lessen the load on the CPU by reducing the number of computation channels or setting a longer scan interval. If a computation data dropout occurs during memory sampling, the data immediately before the dropout is recorded as the computed data of the scan interval in which the dropout occurred.

9.5 Creating Reports

Set how the reports are created.

For a description of the function, see section 1.8.

Setup Screen

- **Report Computation Type**

Press **MENU** (to switch to setting mode), hold down **FUNC** for 3 s (to switch to basic setting mode), and select the **Environment** tab > **Report**.

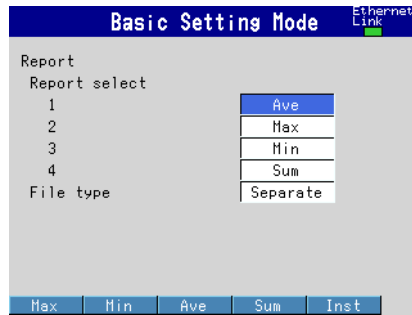

- **Report Type and Time of Creation**

Press **MENU** (to switch to setting mode), hold down **FUNC** for 3 s (to switch to basic setting mode), and select the **Menu** tab > **Report** > **Basic settings**.

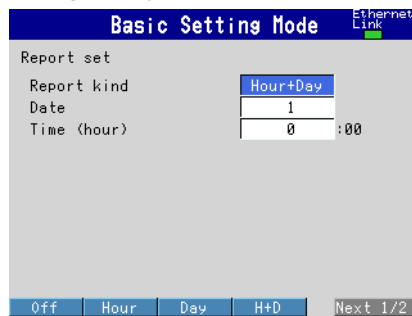

- **Source Channels**

Press **MENU** (to switch to setting mode), hold down **FUNC** for 3 s (to switch to basic setting mode), and select the **Menu** tab > **Report** > **Report settings**.

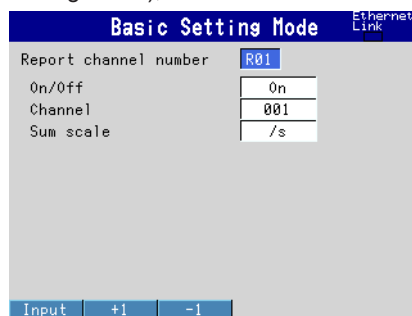

Setup Items

- **Report > Report select > 1, 2, 3, and 4**

Select the type of data to output as reports. The only data type that can be set more than once is Off. You cannot set 1 to Off.

Settings	Description
Off	Does not output reports.
Ave	Outputs the average value.
Max	Outputs the maximum value.
Min	Outputs the minimum value.
Sum	Outputs the sum value.
Inst	Outputs the instantaneous value.

- **Report > File type**

Set this item when creating two types of reports such as daily report and monthly report.

Settings	Description
Separate	Saves each type of report to a separate file. For information about how files are divided, see section 1.4.
Combine	Saves two types of report data in a single file.

- **Report set > Report kind**

Select the type of report to be created.

Settings	Description
Hour	Creates hourly reports.
Day	Creates daily reports.
H+D	Creates hourly and daily reports.
Day+Week	Creates daily and weekly reports.
D+M	Creates daily and monthly reports.

- **Report set > Basic setting > Date/Day of the week, Time (hour)**

Set the date or day of the week and the time when the report is to be created. The specified date/time is when the report file is divided. Set the values in the range indicated below. Items with a dash are invalid.

Report Type	Date	Day of Week	Time
Hour	-	-	0 to 23
Day	1 to 28*	-	0 to 23
H+D	-	-	0 to 23
Day+Week	-	SUN to SAT	0 to 23
D+M	1 to 28*	-	0 to 23

* You cannot specify 29, 30, or 31.

Report Time and Date/Time When the Report File Is Divided

Example: When the Date of a daily report is set to **1** and the **Time (hour)** is set to **18:00**

A daily report is created every day at hour 18.

The file storing the report is divided at 18:00 on day 1 of each month.

- **Report channel number**
The report is output in order by this number.
- **Report channel number > On/Off**
Select **On** for the report channels to be used.
- **Report channel number > Channel**
Set the channel to assign to the report channel. All channels can be assigned, but reports are not created for channels set to **Skip** or **Off** even if they are assigned. Errors are returned for any reports for channels that are set to Log scale (LG1 option). In the stacked bar graph display (see section 4.10 for details), report data is displayed in the following groups. However, only channels that have the same unit as the first channel in the group are displayed.

Report Group	FX1002 and FX1004	FX1006, FX1008, FX1010, and FX1012
1	R01 to R06	R01 to R06
2	R07 to R12	R07 to R12
3	-	R13 to R18
4	-	R19 to R24

- **Report channel number > Sum scale**
Set the sum scale to **/s** to **/day** to match the unit of the measured value.
Example: If the unit of the measured value is "m³/min," select **/min**.
Off: Sums as-is the measured data per scan interval.
- **Handling of Overflow Data**
Overflow data is handled in the same way as it is in statistical computations (TLOG and CLOG).
See section 9.1.

Procedure

- **Starting/Stopping the Report Function**
Starting the memory sampling starts the report function. Likewise, stopping the memory sampling stops the report function.
- **Displaying the Reports**
See section 4.5.
- **Saving the Reports**
See section 1.4.

10.1 A List of Messages

There are cases in which error codes and messages are displayed on the screen during operation. A list of the possible error codes and messages are given in the table below. Communication error codes and messages are also listed.

Error responses to communication commands are output in English.

Errors Related to Parameter Settings

• Setting Errors

Code	Message	Explanation/Countermeasures/Ref. section
1	System error.	Contact your nearest YOKOGAWA dealer.
2	Incorrect date or time setting.	Enter a correct value.
3	A disabled channel is selected.	Specify a channel that is not set to Skip or Off. Specify a channel that is installed.
4	Incorrect function parameter.	See chapter 3 the communication manual.
5	The input numerical value exceeds the set range.	Enter a proper value.
6	Incorrect input character string.	Enter a proper character string.
7	Too many characters.	Enter the correct number of characters.
8	Incorrect input mode.	Specify a correct mode. See section 3.3.
9	Incorrect input range code.	Specify a correct range code. See section 3.3.
11	Range settings are not same within the selected channels.	Specify channels with the same range setting. See section 3.9.
21	Cannot set an alarm for a skipped channel.	Cannot be specified on channels set to Skip. See section 3.7.
22	The upper and lower span limits are equal.	Cannot be set to the same value. See section 3.3.
23	The upper and lower scale limits are equal.	Cannot be set to the same value. See section 3.3.
24	The lower limit of the span band is greater than the upper limit.	Set the lower limit less than the upper limit. See section 3.3.
25	The lower limit of the scale band is greater than the upper limit.	Set the lower limit less than the upper limit. See section 3.3.
26	The scale band is wider than 16 decades of the entire scale.	The Log scale width must be 15 decades or less. See section 3.13.
27	The scale band is less than 1 decade of the entire scale.	The absolute value of the difference between the Log scale upper limit's exponent and the Log scale lower limit's exponent must be at least 1. See section 3.13.
28	Incorrect combination of mantissa and exponent.	Log scale range setting error. See section 3.13.
30	The partial boundary value exceeds the range of the span.	Set the boundary value in the range of "the minimum span value + 1 digit" to "the maximum span value - 1 digit." See section 5.9.
31	Partial-expansion display is set ON for a SKIPPED channel or a LOG channel.	Cannot be specified on channels set to Skip. See sections 3.3 and 5.9
35	The upper and lower limits of the display band are equal.	Set the upper limit greater than the lower limit + 5. See section 5.6.
36	The lower limit of the display band is greater than the upper limit.	Set the upper limit greater than the lower limit + 5. See section 5.6.
37	The display band is narrower than 4% of the entire display.	Set the upper limit greater than the lower limit + 5. See section 5.6.
38	The lower limit of display position is greater than the upper limit.	In the Log scale settings, the channel's color scale band display position has been set so that Scale_L is greater than or equal to Scale_U. See section 3.13.
40	Incorrect group set character string.	Check the syntax. See section 5.1.

10.1 A List of Messages

Code	Message	Explanation/Countermeasures/Ref. section
41	There is no specified input channel.	Specify a channel that is installed. Operation Guide and section 5.1.
42	Exceeded the number of channels which can be set.	Up to 6 channels per group. See section 5.1.
43	A channel number cannot repeat in a group.	Check that a channel is not registered twice. See section 5.1.
45	There is no character string saved in the clipboard.	Copy a character string to the clipboard.
46	The character string saved in the clipboard is too long.	Paste a character string with the specified number of characters.
47	Start and end time cannot match.	Check the starting and ending times. See section 2.1.
48	Invalid or missing DST time settings.	Check the starting and ending times. See section 2.1.
49	"Secondary rated power * 1.2 * VT ratio * CT ratio" is greater than 10GW.	Configure the settings so that "Secondary rated power * 1.2 * VT ratio * CT ratio" is less than 10 GW. See section 3.12.
50	Can't be set correctly due to a power measurement section problem.	An error has occurred in the power measurement section, so the setting cannot be made. Contact your nearest YOKOGAWA dealer to have your FX serviced. See section 3.12.
61	There is no channel specified by the MATH expression.	Check the channel number specified by the expression. See sections 1.8 and 9.1.
62	MATH expression grammar is incorrect.	Check that the expression grammar is correct. See section 9.2.
63	MATH expression sequence is incorrect.	Check that the operator used in the expression in relation to the applicable operands meets the grammar requirements. See section 9.2.
64	MATH upper and lower span values are equal.	Set the upper limit not equal to the lower limit. See section 9.1.
65	Too many operators for MATH expression.	The maximum number of operators in an expression has been exceeded. Reduce the number of operators, such as by splitting up the expression into multiple computation channels. See section 9.2.
70	Nonexistent constant specified in MATH expression.	Check the constant number specified by the expression. See section 9.1.
71	Set range of the MATH constant is exceeded.	Check the selectable range. See section 9.1.
80	This username is already registered.	Register another user name. See section 8.2.
81	All space or 'quit' string cannot be specified.	Change the character string. See section 8.2.
84	The login password has not been set up.	Set a password. See section 8.2.
85	The login password is incorrect.	Check the password. If you lost the password, ask your administrator to reset it. See sections 8.2 and 8.3.
86	The key-lock release password is incorrect.	Check the password. If you lost the password, it must be reset. See section 8.1.
87	This key is locked.	Release the key lock. See section 8.1.
88	This function is locked.	Release the key lock. See section 8.1.
89	Press [FUNC] key to login.	Log in. See section 8.3.
90	No permission to enter to the SETUP mode.	Check the keylock or login settings. See sections 8.2 and 8.3.

Code	Message	Explanation/Countermeasures/Ref. section
91	Password is incorrect.	Enter the correct password. If you lost the password, it must be reset. See sections 8.2 and 8.3.
92	Press [ESC] key to change to the operation mode.	Press the ESC key.
93	String including space or all space cannot be specified.	Spaces are not allowed in the Web browser user name and password. See section 1.5 in the communication manual.
94	More than one address cannot be specified.	Only a single sender is allowed. See section 1.4 in the communication manual.
95	Number entered exceeds channel number range. Use another command.	Check the syntax of the Modbus command. See sections 1.10 and 2.6 in the communication manual.
96	This menu is locked.	Check the key lock setting. Release the key lock. See section 8.1.
100	IP address doesn't belong to class A, B, or C.	Check the IP address. See section 1.3 in the communication manual.
101	The result of the masked IP address is all 0s or 1s.	Check the subnet mask. See section 1.3 in the communication manual.
102	SUBNET mask is incorrect.	Check the subnet mask. See section 1.3 in the communication manual.
103	The net part of default gateway is not equal to that of IP address.	Check the IP address. See section 1.3 in the communication manual.
105	This port number is already in use. Please enter a different number.	Enter a different port number for each function. See section 6.1 in the communication manual.
110	This user name is not registered.	Log in as a registered user. See section 8.3.
113	Password entered is incorrect.	Enter the correct password. See section 8.3.
116	This user name cannot be specified.	The user name is reserved. See section 8.2.
119	This user name is unable to use this mode.	A user-level user cannot enter the Basic Setting mode See section 8.2.
120	Measured value is incorrect. (in ascending order)	Set the calibration correction value to a value greater than the previous value. See section 3.9.
122	Measured value exceeds the range setting.	Check the channel input or the channel range setting. See sections 3.3 and 3.9.
124	Password entry cannot be performed.	You cannot enter a password.
125	Character entry cannot be performed.	A display used to enter character screens is not being shown on the FX. See section 2.10.
126	You cannot use the same password.	Specify a different password. See section 8.3.
127	Report kind overlaps and cannot be set up.	Change the overlapped report data type. See section 9.5.
128	"Logout" cannot be set to "Hide".	See sections 5.16 and 8.3.

10.1 A List of Messages

• Execution Errors

Code	Message	Explanation/Countermeasures/Ref. section
150	This action is not possible because sampling is in progress.	Stop the memory sampling and then execute. See section 6.4.
151	This action is not possible during sampling or calculating.	Stop the memory sampling and then execute. See sections 6.4 and 9.4.
152	This action is not possible because saving is in progress.	Wait until the saving is complete.
153	This action is not possible because formatting is in progress.	Wait until the formatting is complete.
154	Message not accepted because message limit was reached.	The limit is 50 messages. See section 5.4.
155	The message is not written while sampling is stopped.	Start the memory sampling and then execute. See section 6.4.
156	There are no channels to be saved to the memory.	Set the channels to be saved. See sections 6.1 and 9.1.
157	This function is not possible at this time.	Check the FX status.
158	Exceeds time deviation setting.	When synchronizing the clock through remote control.
159	It is outside the postscript message write-in range.	Add message can be written to the past section of the data being memory sampled. See section 5.4.

Operation Errors

Code	Message	Explanation/Countermeasures/Ref. section
200	Operation aborted because an error was found in media.	Use another storage medium or format it. See section 6.7.
201	Not enough free space on media.	There is not enough free space on media or the number of directories exceeded the limit. Use another storage medium. See section 1.4.
202	Media is read-only.	Make it writable.
210	Media has not been inserted.	Insert a storage medium into the drive.
211	Media is damaged or not formatted.	Remove the medium and set it again. If an error still occurs, replace or format the medium. See section 6.7. Remove the write protection if it is enabled.
212	Format error.	Try formatting again. See section 6.7.
213	The file is read-only.	Access another file or make the file writable.
214	There is no file or directory.	Specified a file in which data is being added. Tried to save a file which does not exist in the internal memory.
215	Exceeded the allowable number of directories or files.	Replace a storage medium. Delete unneeded files and directories. See section 6.7.
216	The file or directory name is incorrect.	Use alphanumeric characters and symbols. See section 6.2.
217	Unknown file type.	Check the extension. See section Appendix 2.
218	This directory or file now exists. Delete it or change the name.	See section 6.2.
219	Invalid file or directory operation.	Tried to delete multiple directory levels. Or, tried to delete a directory containing files. Delete the files and directories in the directory first before executing the operation. See section 6.7.
220	The file is already in use. Try again later.	Wait until the file is accessible.
221	This action is not possible because FTP transmission is in progress.	Execute after FTP data transfer is complete.
222	Media is not recognized.	Remove and reset the storage medium.
231	Abnormal setting exists in file.	Specify another file.
232	There is no available data.	Appears when displaying historical trends. Specify another file.
233	The specified historical data do not exist.	Appears when switching to historical trend from information display. See section 4.5.
234	The specified channel is not assigned to the display group.	Appears when switching to trend, digital, or bar graph from overview. See sections 4.4 and 5.1.

Communication Application Errors

• Errors Related to E-mail and Web Server

260	IP address is not set or ethernet function is not available.	The IP address is not specified. Check the IP address. See section 1.3 in the communication manual.
261	SMTP server is not found.	Occurs when the SMTP server is specified by name. <ul style="list-style-type: none">• Check the DNS setting.• Check the SMTP server name. See sections 1.3 and 1.4 in the communication manual.
262	Cannot initiate E-mail transmission.	<ul style="list-style-type: none">• The host name of the FX is not correct. Check the host name.• The port number of the SMTP server is not correct. Check the port number. See sections 1.3 and 1.4 in the communication manual.
263	Sender's address rejected by the server.	Check the sender's address. Section 1.4 in the communication manual
264	Some recipients' addresses are invalid.	Check the recipients' addresses. See section 1.4 in the communication manual. Check whether "Authentication" in the transmission settings is set correctly.
265	SMTP protocol error.	May occur if a network failure (cable problems, duplicate addresses, network device failure, and so on) occurs in the middle of the e-mail transmission.
266	Ethernet cable is not connected.	Check the cable connection. See section 1.3 in the communication manual.
267	Could not connect to SMTP server.	<ul style="list-style-type: none">• Check to see that the SMTP server is connected to the network.• If the SMTP server name is specified using an IP address, check to see that the IP address is correct. See section 1.4 in the communication manual.
268	E-mail transmission request failed.	Contact your nearest YOKOGAWA dealer.
269	E-mail transfer error.	May occur if a network failure (cable problems, duplicate addresses, network device failure, and so on) occurs in the middle of the e-mail transmission.
270	Could not connect to POP3 server	Check the connection settings. See section 1.4 in the communication manual.
271	Not able to login to the POP3 server.	Check the login name and the password. See section 1.4 in the communication manual.
272	SMTP authentication failed.	Make sure that the user name and password that you are using for authentication are recognized by the server. See section 1.4 in the communication manual.
273	The server requested an unsupported authentication method.	Change the server configuration. See section 1.4 in the communication manual.
275	The current image cannot be output to the Web.	The setup display cannot be output to the Web browser. This message is displayed on the Web browser.
276	Image data currently being created. Unable to perform key operation.	Try again a little later. This message is displayed on the Web browser.
277	Could not output screen to Web.	Failed to create the image. This message is displayed on the Web browser.

- **Errors Related to the FTP Client, SNTP, and DHCP**

For a description of the FTP client function of the FX, see the *Communication Interface User's Manual*, IM 04L41B01-17EN. The detail code does not appear in the error message on the screen. You can view the code on the FTP log display of the FX or using the FTP log output via communications.

Code	Message
280	<p>IP address is not set or FTP function is not available.</p> <p>Further details are provided by the character string that appears after error code 280.</p> <p>Character String and Details</p> <p>HOSTADDR An IP address has not been assigned to the FX. Check the IP address.</p> <p>DORMANT Internal processing error.¹</p> <p>LINK Data link is disconnected. Check the cable connection.</p>
281	<p>FTP mail box operation error.</p> <p>Further details are provided by the character string that appears after error code 281.</p> <p>Character String and Details</p> <p>MAIL Internal processing error.¹</p> <p>STATUS Internal processing error.¹</p> <p>TIMEOUT Internal processing error.¹</p> <p>PRIORITY Internal processing error.¹</p> <p>NVRAM Internal processing error.¹</p>
282	<p>FTP control connection error.</p> <p>Further details are provided by the character string that appears after error code 282.</p> <p>Character String and Details</p> <p>HOSTNAME Failed the DNS lookup (search the IP address corresponding to the host name). Check the DNS setting and the destination host name.</p> <p>TCPIP Internal processing error.¹</p> <p>UNREACH Failed to connect to a control connection server. Check the address setting and that the server is running.</p> <p>OOBINLINE Internal processing error.¹</p> <p>NAME Internal processing error.¹</p> <p>CTRL The control connection does not exist. Check that the server does not drop the connection and that it responds within the proper time period.</p> <p>IAC Failed to respond in the TELNET sequence. Check that the server does not drop the connection and that it responds within the proper time period.</p> <p>ECHO Failed to transmit data on the control connection. Check that the server does not drop the connection and that it responds within the proper time period.</p> <p>REPLY Failed to receive data on the control connection. Check that the server does not drop the connection and that it responds within the proper time period.</p> <p>SERVER The server is not in a condition to provide the service. Check that the server is in a condition in which service can be provided.</p>

10.1 A List of Messages

Code	Message
283	<p>FTP command was not accepted.</p> <p>Further details are provided by the character string that appears after error code 283.</p> <hr/> <p>Character String and Details</p> <hr/> <p>USER</p> <p>Failed to verify the user name. Check the user name setting.</p> <p>PASS</p> <p>Failed to verify the password. Check the password setting.</p> <p>ACCT</p> <p>Failed to verify the account. Check the account setting.</p> <p>TYPE</p> <p>Failed to change the transfer type. Check that the server supports the binary transfer mode.</p> <p>CWD</p> <p>Failed to change the directory. Check the initial path setting.</p> <p>PORT</p> <p>Failed to set the transfer connection. Check that the security function is disabled.</p> <p>PASV</p> <p>Failed to set the transfer connection. Check that the server supports PASV commands.</p> <p>SCAN</p> <p>Failed to read the transfer connection settings. Check that proper response to the PASV command is received from the server.</p> <hr/>
284	<p>FTP transfer setting error.</p> <p>Further details are provided by the character string that appears after error code 284.</p> <hr/> <p>Character String and Details</p> <hr/> <p>MODE</p> <p>Internal processing error.¹</p> <p>LOCAL</p> <p>Internal processing error.¹</p> <p>REMOTE</p> <p>The destination file name is not correct. Check that you have the authority to create or overwrite files.</p> <p>ABORT</p> <p>File transfer abort was requested by the server. Check the server for the reason for the abort request.</p> <hr/>

Code	Message
285	<p>FTP data connection error.</p> <p>Further details are provided by the character string that appears after error code 285.</p> <hr/> <p>Character String and Details</p> <hr/> <p>SOCKET Failed to create a socket for the transfer connection.²</p> <p>BIND Failed the transfer connection command.²</p> <p>CONNECT Failed the transfer connection.²</p> <p>LISTEN Failed the transfer connection reception.²</p> <p>ACCEPT Failed to accept the transfer connection.²</p> <p>SOCKNAME Internal processing error.¹</p> <p>RECV Failed to receive data over the transfer connection.²</p> <p>SEND Failed to send data over the transfer connection.²</p>
286	FTP file transfer error.
290	<p>SNTP access failure.</p> <p>Further details are provided by the character string that appears after error code 290.</p> <hr/> <p>Character String and Details</p> <hr/> <p>DORMANT Internal processing error.¹</p> <p>LINK Data link is disconnected. Check the cable connection.</p>
291	<p>SNTP server does not respond.</p> <p>Further details are provided by the character string that appears after error code 291.</p> <hr/> <p>Character String and Details</p> <hr/> <p>TIMEOUT Check that the server is running.²</p>
292	<p>Incorrect SNTP server setting.</p> <p>Further details are provided by the character string that appears after error code 292.</p> <hr/> <p>Character String and Details</p> <hr/> <p>HOSTNAME Failed the DNS lookup (search the IP address corresponding to the host name). Check the DNS setting and the SNTP server name.</p> <p>TCPIP Internal processing error.¹</p>
293	<p>Invalid SNTP server reply.</p> <p>Further details are provided by the character string that appears after error code 293.</p> <hr/> <p>Character String and Details</p> <hr/> <p>SEND A correct IP address has not been assigned to the FX. Check the IP address.</p> <p>BROKEN There is a problem with the SNTP server. If this error occurs even after executing SNTP manually several times, check the SNTP server.</p>

10.1 A List of Messages

Code	Message
294	No time correction because excess time deviation with SNTP server. Further details are provided by the character string that appears after error code 294. Character String and Details OVER This error occurs when periodic SNTP is executed by the auto setting of the clock and the clock is not adjusted because the time difference between the FX and the SNTP server is greater than or equal to 10 minutes. Check the time on the FX and the SNTP server.
295	IP address was released because DHCP setting is invalid. Further details are provided by the character string that appears after error code 295. Character String and Details REJECT Address obtained by DHCP is inappropriate.
296	DHCP access failure. Further details are provided by the character string that appears after error code 296. Character String and Details ESEND Failed to transmit to the DHCP. ESERVER DHCP server not found. ESERVFAIL No response from the DHCP server. ERENEWED Address renewal rejected. EEXTENDED Address lease extension rejected. EEXPIRED Address lease period expired.
297	Registration of the hostname to the DNS server failed. Further details are provided by the character string that appears after error code 297. Character String and Details INTERNAL Failed to register the host name (transmission error, reception timeout, etc.). FORMERR Failed to register the host name (format error: DNS message syntax error). SERVFAIL Failed to register the host name (server failure: DNS server processing error). NXDOMAIN Failed to register the host name (non existent domain). NOTIMP Failed to register the host name (not implemented). REFUSED Failed to register the host name (operation refused). YXDOMAIN Failed to register the host name (name exists). YXRRSET Failed to register the host name (RR set exists). NXRRSET Failed to register the host name (RR set does not exist). NOTAUTH Failed to register the host name (not authoritative for zone). NOTZONE Failed to register the host name (different from zone section). NONAME Host name not entered on the FX.

Code	Message
298	<p>Deletion of the hostname to the DNS server failed.</p> <p>Further details are provided by the character string that appears after error code 298.</p> <hr/> <p>Character String and Details</p> <hr/> <p>INTERNAL Failed to delete the host name (transmission error, reception timeout, etc.).</p> <p>FORMERR Failed to delete the host name (format error: DNS message syntax error).</p> <p>SERVFAIL Failed to delete the host name (server failure: DNS server processing error).</p> <p>NXDOMAIN Failed to delete the host name (non existent domain).</p> <p>NOTIMP Failed to delete the host name (not implemented).</p> <p>REFUSED Failed to delete the host name (operation refused).</p> <p>YXDOMAIN Failed to delete the host name (name exists).</p> <p>YXRRSET Failed to delete the host name (RR set exists).</p> <p>NXRRSET Failed to delete the host name (RR set does not exist).</p> <p>NOTAUTH Failed to delete the host name (not authoritative for zone).</p> <p>NOTZONE Failed to delete the host name (different from zone section).</p> <p>NOTLINKED 4Physical layer was disconnected when removing the host name.</p>

- 1 Contact your nearest YOKOGAWA dealer.
- 2 These errors may occur if the network experiences trouble during the data transmission (bad cable connection, duplicate addresses, network equipment failure).

Note

- The FTP client function on the FX has a timer function that drops the connection if there is no data transfer for two minutes. If the server does not respond within this time period, the transfer fails.
- The FTP client function on the FX overwrites files without a warning if files with the same name exist at the transfer destination unless the server returns a negative response.

Communication Errors

For information about the FX communication functions, see the *Communication Interface User's Manual*, IM 04L41B01-17EN.

- **Errors during Setting and Basic Setting Modes, Output Communication Command Execution, and Setup Data Loading**

Code	Message
300	Command is too long.
301	Too many number of commands delimited with ';'.
302	This command has not been defined.
303	Data request command can not be enumerated with sub-delimiter.
350	Command is not permitted to the current user level.
351	This command cannot be specified in the current mode.
352	The option is not installed.
353	This command cannot be specified in the current setting.
354	This command is not available during sampling or calculating.

- **Memory Access Errors during Setting and Basic Setting Modes and Output Communication Command Execution**

An English error message is returned via the communication interface. These messages are not displayed on the FX.

Code	Message
362	There are no data to send 'NEXT' or 'RESEND'.
363	All data have already been transferred.

- **Maintenance and Test Communication Command Errors**

An English error message is returned via the communication interface. These messages are not displayed on the FX.

Code	Message
390	Command error.
391	Delimiter error.
392	Parameter error.
393	No permission.
394	No such connection.
395	Use 'quit' to close this connection.
396	Failed to disconnect.
397	No TCP control block.
398	Format error.

- **Other Communication Errors**

An English error message is returned via the communication interface. These messages are not displayed on the FX.

Code	Message
400	Input username. Enter the name of a user that is registered on the FX and that is allowed to log into the FX through communication commands.
401	Input password. Enter the password.
402	Select username from 'admin' or 'user'. Select "admin" or "user" to specify the user level to connect to.
403	Login incorrect, try again! The login failed. Enter the information again, starting with the user name.
404	No more login at the specified level is acceptable. Connecting would cause the maximum number of simultaneous connections (administrator: 1, normal user: 2) to be exceeded. Connect to a different level, or exit by entering "quit."
420	Connection has been lost. The connection has been lost.
421	The number of simultaneous connection has been exceeded. The maximum number of simultaneous connections has been reached, so no further connections can be made.
422	Communication has timed-out. Communication timed out so the connection was closed.

10.1 A List of Messages

Status Messages

Code	Message
500	Execution is complete.
501	Please wait a moment...
503	Data are being saved to media...
504	File is being loaded from media...
505	Formatting...
506	Memory save to media was interrupted.
508	There is no file or directory.
509	Press [DISP/ENTER] key to display file name.
510	Range cannot be changed during sampling or calculating.
511	MATH expression cannot be changed during sampling or calculating.
513	Post process in progress.
514	Now loading historical data.
515	Data save is completed.
516	Files are now being sorted.
520	Connecting to the line...
521	The data file is being transferred.
530	Media can be removed safely.
531	Media was removed compulsorily.
532	USB device has been connected.
533	USB device cannot be recognized.
534	There was no data which is not saved to media.
535	Media was recognized.
542	Media read error.
543	Flash write error.
550	The A/D calibration is being executed...
551	FTP test is being executed...
552	E-mail test is being executed...

Code	Message
560	Now connecting to SNTP server.
561	Now adjusting the time.
562	Ethernet cable is disconnected. Further details are provided by the character string that appears after error code 562. Character String and Details ON Detected that an Ethernet cable was connected. OFF Detected that an Ethernet cable was disconnected.
563	The command is sent to DHCP. Further details are provided by the character string that appears after error code 563. Character String and Details RENEW Requesting address renewal to the DHCP server.
564	The response was received from DHCP. Further details are provided by the character string that appears after error code 564. Character String and Details RENEWED Address renewal complete. EXTENDED Address release extension request complete. RELEASED Address release complete.
565	IP address was set. Further details are provided by the character string that appears after error code 565. Character String and Details IPCONFIG Assigned the IP address.
566	It is a setting that doesn't register hostname to the DNS server. Further details are provided by the character string that appears after error code 566. Character String and Details NOREQUEST Configured not to register the host name.
567	The hostname was registered to DNS server. Further details are provided by the character string that appears after error code 567. Character String and Details UPDATE Registered the host name to the DNS server.
568	The hostname was deleted from DNS server. Further details are provided by the character string that appears after error code 568. Character String and Details REMOVE Assigned the IP address. OFF Deleted the host name from the DNS server.

10.1 A List of Messages

Warning Messages

Code	Message	Ref. Section
600	Measured data and Settings have been initialized.	–
601	Measured data have been initialized.	–
610	This username is already registered.	See section 8.2.
614	Calibration settings are reset because of range setting change.	See section 3.9.

System Errors

Servicing is required when a system error occurs. If this happens, contact your nearest YOKOGAWA dealer.

Code	Message	Description
901	ROM failure.	–
902	RAM failure.	–
910	A/D memory failure for all input channels.	–
915	Failed to measure power.	The FX temporarily failed to measure one of the elements used to calculate the power.
916	The power measurement function failed.	This is displayed when a malfunction is detected in the power measurement section. The computation icon is displayed in red.
921	Channel 1 A/D calibration value error.	–
925	A/D calibration error.	–
930	Memory acquisition failure.	–
940	The Ethernet module is down.	–
950	Incorrect number for the A/D calibration.	–
951	Failed to write A/D calibration value.	–

This error appears on the startup screen.

Servicing is required. Contact your nearest YOKOGAWA dealer for repairs.

Code	Message	Explanation
–	Code Flash Sum Error	Firmware error.

10.2 Troubleshooting

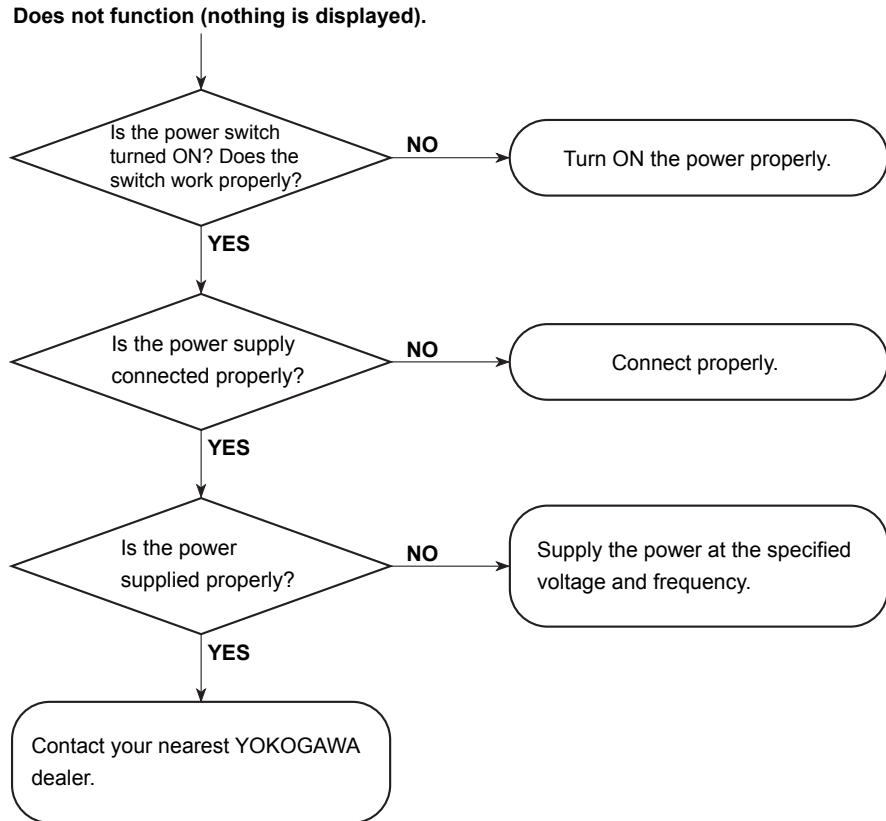

10.2 Troubleshooting

- Large measurement errors
- Trend or digital wave value fluctuation
- Trend going off the scale beyond either 0% or 100%

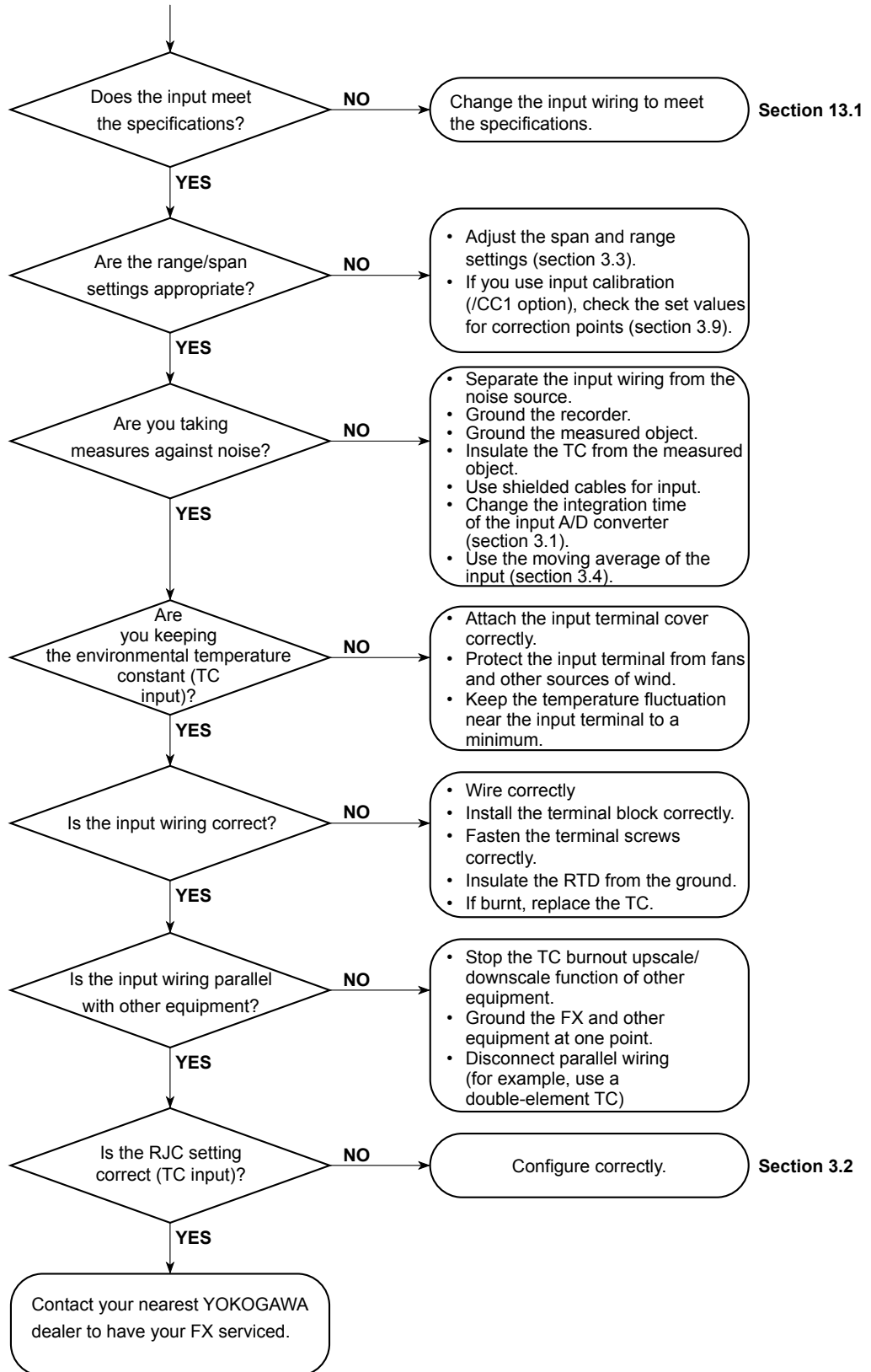

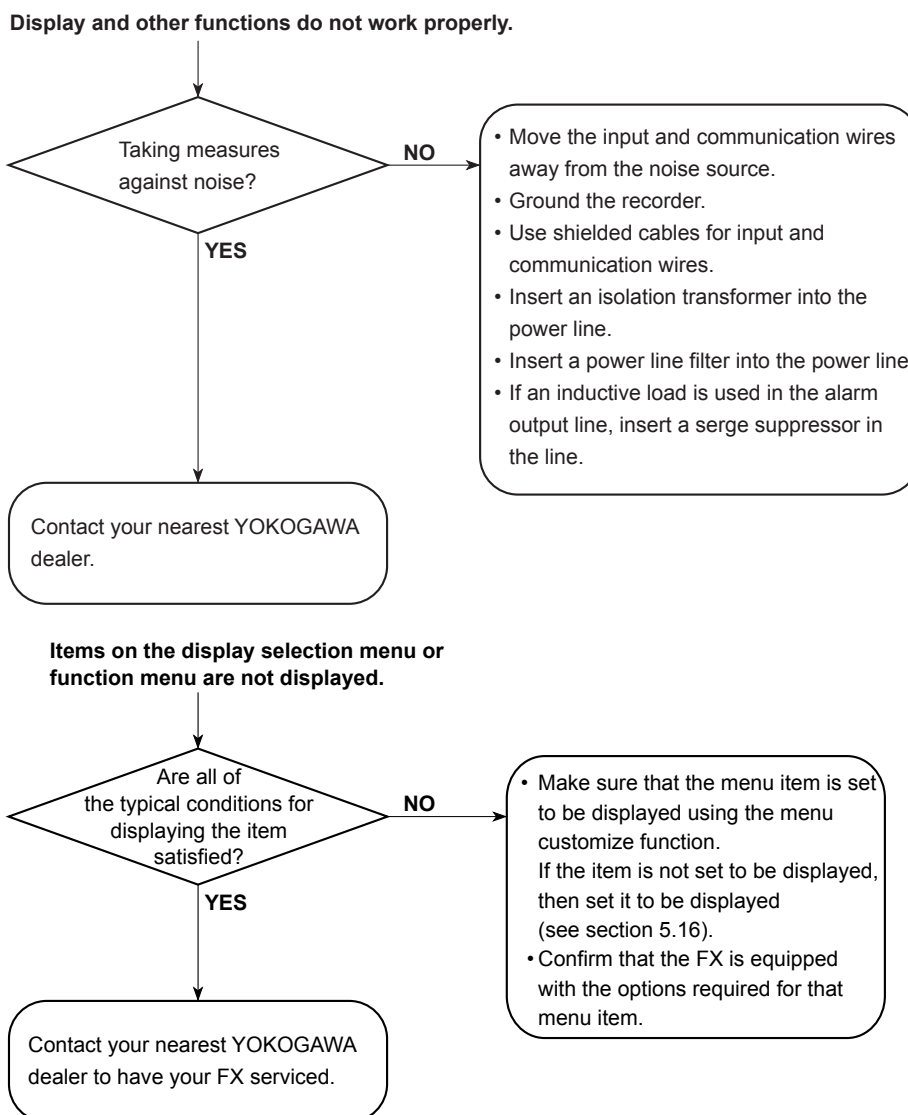

11.1 Periodic Inspection

Check the operation periodically to keep the FX in good working order. Perform the following inspections, and then contact your YOKOGAWA dealer if necessary.

- Is the display and storage functioning properly?
If not, see chapter 10, "Troubleshooting."
- Has the brightness of the LCD backlight deteriorated?

Service Life of Consumable Parts

The service lives for parts that wear down are shown in the following table. These service lives are estimated values that have been calculated assuming that the product is used under standard operating conditions. These values are not guaranteed.

Item	Replacement Period	Part Name
LCD	8 years	LCD
Battery	10 years	Sub board
Rubber packing for dust and water protection	5 years	Packing
Aluminum electrolytic capacitor	5 years*	Power supply assembly
	5 years*	AD assembly

* The replacement period when the FX is used at the upper limit of the normal operating temperature (50°C) varies depending on the usage environment temperature and the FX specifications. When the usage environment temperature is 30°C, the replacement period may be 10 years or more.

Note

- The service life of the LCD indicates the point in time when the LCD brightness is half of its initial value. The brighter that you set the LCD, the shorter its replacement period becomes. The decrease in the LCD brightness varies depending on the usage conditions, and the judgment of the LCD's brightness is subjective.
- With the passage of time, the LCD may be tinged yellow. The brighter that you set the LCD, the faster it will discolor.
- If the rubber packing has come loose, attach it so that the protrusions are on the bottom as shown in the figure below. Attaching it upside down will hamper the dust proofing and waterproofing. Attach it firmly, depressing the rib lightly with a finger.

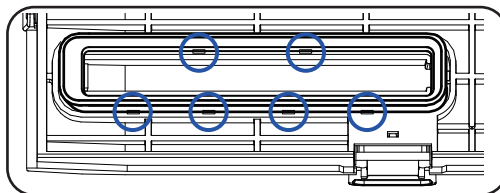

11.2 Calibrating the FX

It is recommended that the FX be calibrated once a year to assure its measurement accuracy.

Calibration service is also provided by YOKOGAWA dealers.

For details, contact your nearest YOKOGAWA dealer.

Required Instruments

Calibration instruments with the following resolution are required for calibrating the FX.

Recommended Instruments

- DC voltage standard: Fluke 9100 or equivalent
Main specifications
Output accuracy: $\pm(0.005\% + 1 \mu\text{V})$
- Decade resistance box: Yokogawa Meters & Instruments Model 2793-01 or equivalent
Main specifications
Accuracy of output range 0.1 to 500 Ω :
 $\pm(0.01\% + 2 \text{ m}\Omega)$
Resolution: 0.001 Ω
- 0°C standard temperature device: ZC-114/ZA-10 by Coper Electronics or equivalent
Main specifications
Standard temperature stability accuracy: $\pm 0.05^\circ\text{C}$

For information on purchasing the calibration instruments, contact your nearest YOKOGAWA dealer.

Calibration Procedure

1. Wire the FX and the calibration instrument as shown in the following figure, and adequately warm up the instruments (the warm-up time of the FX is at least 30 minutes).
2. Check that the operating environment such as ambient temperature and humidity is within the standard operating conditions (see section 13.6).
3. Apply appropriate input signals corresponding to 0, 50, and 100% of the input range and calculate the errors from the readings.
If the error does not fall within the accuracy range of the specifications, contact your nearest YOKOGAWA dealer.

Note

For thermocouple inputs, you must measure the temperature of the input terminal and apply a voltage taking into account the reference junction temperature.

DC Voltage Measurement (Example for the FX1012)

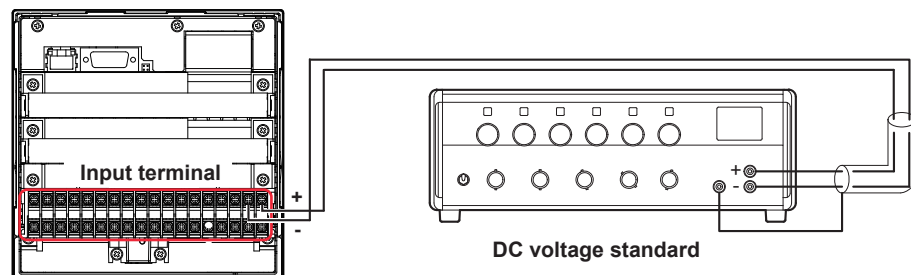

Temperature Measurement Using an RTD (Example for the FX1012)

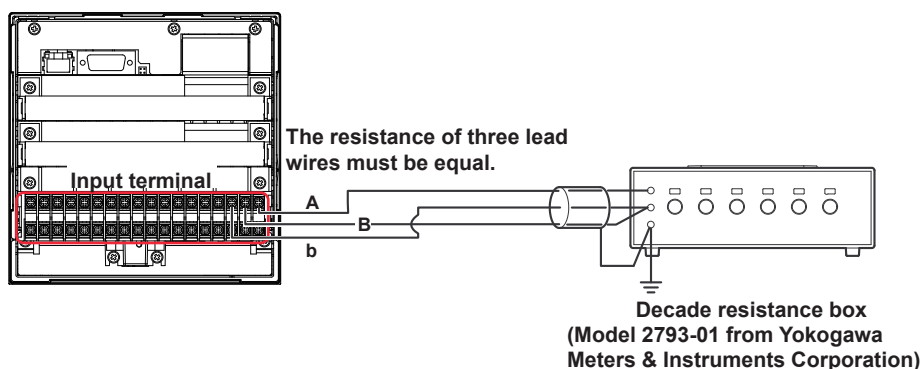

Temperature Measurement Using a Thermocouple (Example for the FX1012)

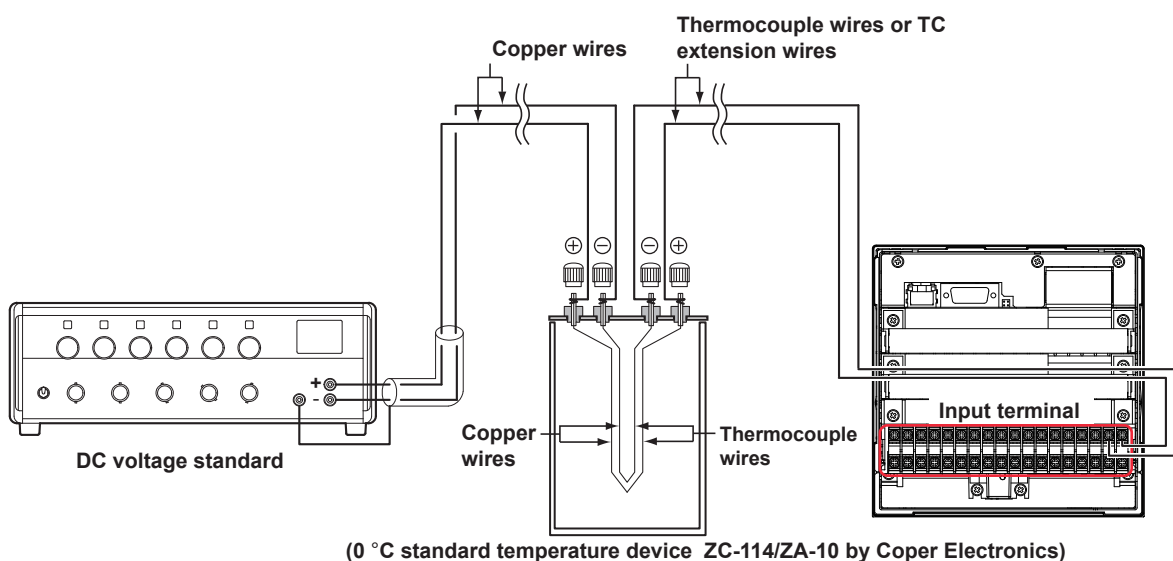

RJC of TC Input

As the measurement terminal of the FX is generally at room temperature, the actual output of the thermocouple is different from the values given on the thermoelectromotive force table based on 0°C. The FX performs compensation by measuring the temperature at the input terminal and adding the corresponding thermoelectromotive force to the actual output of the thermocouple. Therefore, when the measurement terminal is shorted (equivalent to the case when the detector tip is 0°C), the measured value indicates the temperature of the input terminal.

When calibrating the FX, this compensation voltage (thermoelectromotive force of 0°C reference corresponding to the input terminal temperature) must be subtracted from the output of the standard generator before application. As shown in the figure, by using the 0°C standard temperature device to compensate the reference junction at 0°C, you can input the thermoelectromotive force of 0°C reference from the DC voltage standard and perform the calibration.

12.1 Installation Location

Install the FX indoors in an environment that meets the following conditions:

- **Instrumentation Panel**
The FX is designed to be installed in an instrumentation panel.
- **Well-Ventilated Location**
To prevent overheating, install the FX in a well-ventilated location. For the panel cut dimensions when arranging multiple FXs, see section 12.3. When other instruments are installed next to the FX, follow the panel cut dimensions to provide adequate space around the FX.
- **Minimal Mechanical Vibrations**
Install the FX in a location that has minimal mechanical vibrations. Installing the FX in a location that is subject to large levels of mechanical vibration will not only put added stress on its components, it may also impede ordinary measurement.
- **Level Location**
Install the FX in a level location so that it is not slanted to the left or the right (however, the FX can be inclined up to 30 degrees backward for panel mounting).
- **Ambient temperature range between 0 to 50°C**
- **Ambient humidity between 20 to 80%RH (However, less than moisture content of 40°C 80% RH at 40°C or more), No condensation should be present.**
- **Altitude 2000 m or less**

Note

Condensation may form when moving the FX from an environment whose temperature or humidity is low to an environment whose temperature or humidity is high, or when there is a sudden change in temperature. Temperature or humidity changes may also result in thermocouple measurement errors. In these kinds of circumstances, let the FX adjust to the new environment for at least an hour before using it.

Do not install the FX in the following places.

- **Outdoors**
- **In Direct Sunlight or Near Heat Sources**
Install the FX in a place that is near room temperature (23°C) and that is not subject to large temperature fluctuations. Placing the FX in direct sunlight or near heat sources can cause adverse effects on the internal circuitry.
- **Where an Excessive Amount of Soot, Steam, Moisture, Dust, or Corrosive Gases Are Present**
Soot, steam, moisture, dust, and corrosive gases will adversely affect the FX. Avoid installing the FX in such locations.
- **Near Strong Magnetic Field Sources**
Do not bring magnets or instruments that produce electromagnetic fields close to the FX. Operating the FX near strong magnetic fields can cause measurement errors.
- **Where the Display Is Difficult to See**
The FX uses an LCD screen, so it is difficult to view the display from an extreme angle. Install the FX so that the user can view the display directly from the front.

12.2 Installation Procedure

Use a steel panel that is 2 mm to 26 mm thick.

1. Insert the FX through the front of the panel.
2. Mount the FX to the panel using the included mounting brackets as shown in the figure below.
 - Use two mounting brackets to support the top and bottom or the left and right sides of the case (remove the stickers that are covering the holes before you attach the brackets).
 - Follow the procedure below to mount the FX to the panel.
 - First, attach the two mounting brackets and temporarily tighten the mounting screws.
 - Next, fix the FX in place by tightening the mounting screws with the appropriate torque. When the FX is approximately perpendicular to the panel, press the mounting brackets so that they are in contact with the case, and fully tighten the mounting screws.
 - Tighten the mounting bracket screws until you hear clicks.

CAUTION

- Using more than the appropriate torque to tighten the screws can deform the case or damage the brackets.
- Be sure not to insert foreign objects or tools into the case through the mounting bracket holes.
- Do not touch the screw at the top of the mounting bracket (A). Loosening or tightening this screw may cause the FX to malfunction.

Panel Mounting Diagram

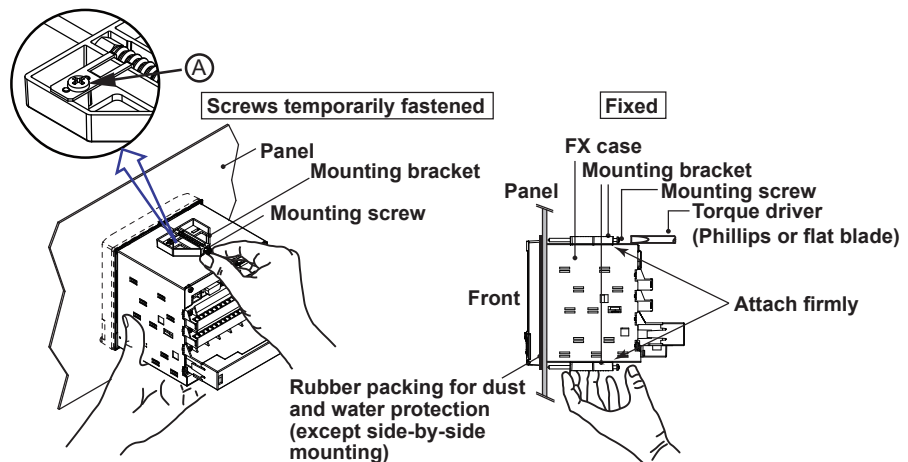

(In the figure, the mounting brackets are used on the top and bottom of the case.)

Note

To achieve sufficient dust proofing and waterproofing, attach the included rubber packing to the FX, and then mount the FX in the middle of the panel cut out.

However, do not use the rubber packing if you are mounting two instruments side by side or one on top of the other.

12.3 External Dimensions and Panel Cut Dimensions

External dimensions

Unit: mm (approx. inch)

If not specified, the tolerance is $\pm 3\%$.

However, in cases of less than 10mm, the tolerance is ± 0.3 mm.

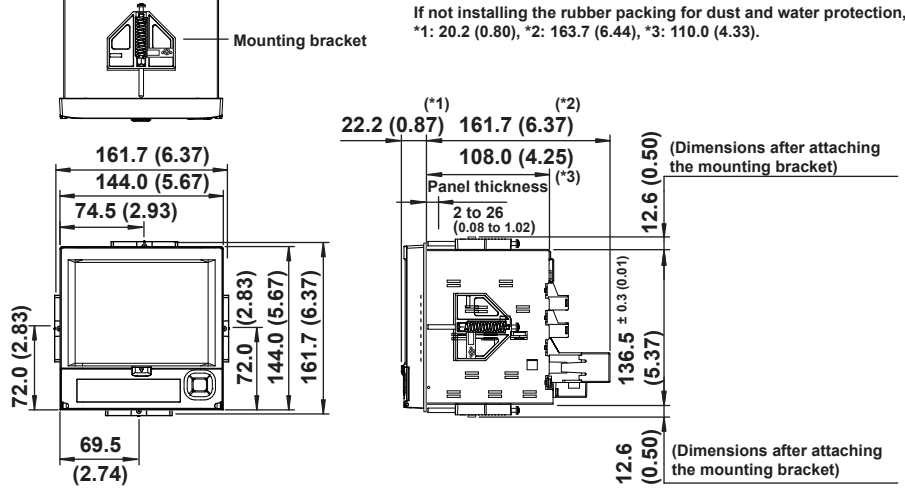

Panel cut dimensions

Single-unit mounting

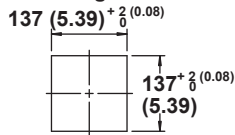

Side-by-side mounting (horizontally)

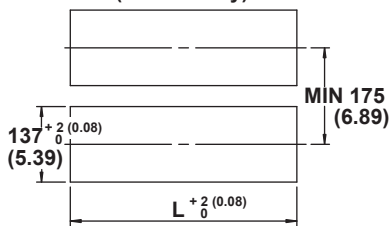

Side-by-side mounting (vertically; max. 3 units)

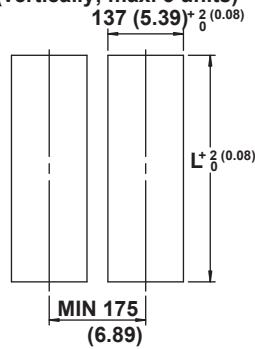

Units	$L \pm \frac{2}{0} (0.08)$ in mm (approx. inches)
2	282 (11.10)
3	426 (16.77)
4	570 (22.44)
5	714 (28.11)
6	858 (33.78)
7	1002 (39.45)
8	1146 (45.12)
9	1290 (50.79)
10	1434 (56.46)
n	$(144 \times n) - 6 [(5.67 \times n) - 0.24]$

12.4 Input Signal Wiring



WARNING

- To prevent electric shock while wiring, make sure that the power supply is turned off.

CAUTION

- Applying a strong tension to the input and output signal cables connected to the FX may damage the cables or the FX terminals. To avoid applying tension directly to the terminals, fix all cables to the rear of the mounting panel.
- To prevent fire, use signal cables with a temperature rating of 70°C or more.
- Do not apply voltages that exceed the following values to the input terminals. Doing so may damage the FX.
 - Maximum input voltage: ± 60 VDC
 - Maximum common mode voltage: ± 60 VDC (under measurement category II conditions)

Precautions to Be Taken While Wiring

Take the following precautions when wiring the input signal cables.

When using a screw terminal, we recommend that you use a crimp-on lug with an insulation sleeve (designed for 3 mm screws).



Crimp-on lug (designed for 3 mm screws) with an insulation sleeve

Take measures to prevent noise from entering the measurement circuit.

- Move the measurement circuit away from the power cable (power circuit) and ground circuit.
- Ideally, the object being measured should not generate noise. However, if this is unavoidable, isolate the measurement circuit from the object. Also, ground the object being measured.
- Shielded wires should be used to minimize the noise caused by electrostatic induction. Connect the shield to the ground terminal of the FX as necessary (make sure you are not grounding at two points).
- To minimize noise caused by electromagnetic induction, twist the measurement circuit wires at short, equal intervals.
- Make sure to earth ground the protective ground terminal through minimum resistance (less than 100 Ω).

Do not allow static electricity to be applied to the terminals.

- When wiring the terminals, remove static electricity so that static electricity is not applied.
- If static electricity or similar high-voltage transient noise is applied to the signal line, the system may break.

When using internal reference junction compensation on the thermocouple input, take measures to stabilize the temperature at the input terminal.

- Always use the terminal cover.
- Do not use thick wires which may cause large heat dissipation (we recommend a cross sectional area of 0.5 mm² or less).
- Make sure that the ambient temperature remains reasonably stable. Large temperature fluctuations can occur if a nearby fan turns on or off.

Connecting the input wires in parallel with other devices can cause signal degradation, affecting all connected devices. If you need to make a parallel connection, then

- Turn the burnout detection function off.
- Ground the instruments to the same point.
- Do not turn other instruments on or off during operation. This can have adverse effects on the other instruments.
- RTDs cannot be wired in parallel.

Wiring Procedure

A terminal cover is attached to the measuring input terminal block on the rear panel. A label indicating the terminal arrangement is affixed to the cover.

1. Turn the recorder off, and remove the terminal cover. To remove the cover, pull the right-and-left pawls.
2. Connect the signal cables to the terminals.

Recommended torque for tightening the screws	0.5 N•m
--	---------

3. Replace the terminal cover.

Arrangement of the Input Terminals

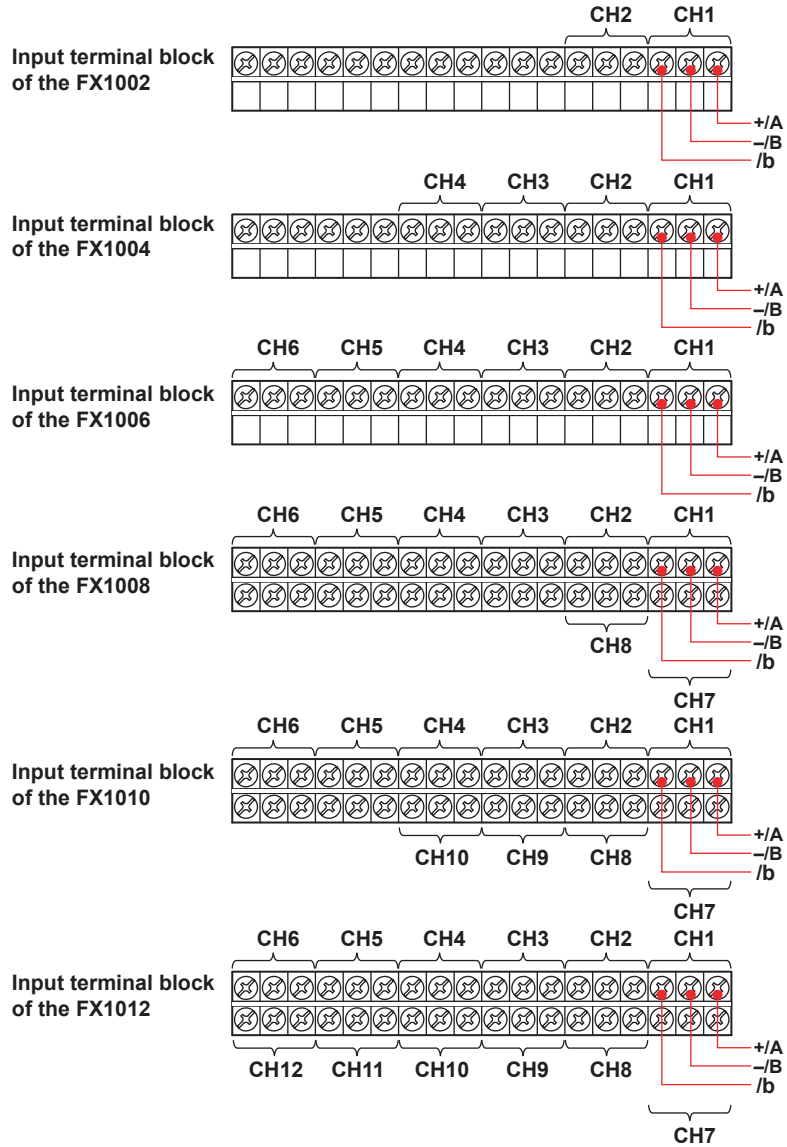
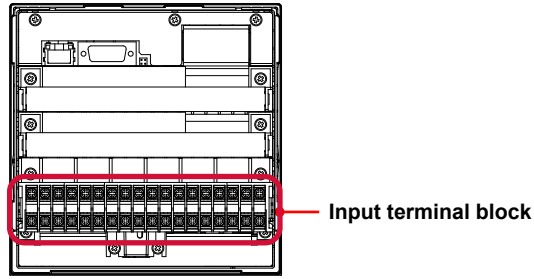

For TC input, use shielded compensating lead wires for wiring.
 For RTD input, lead wire resistance per wire of 10 Ω or less. Make the resistances of the three wires equal.
 For DCA input, example: for 4 to 20 mA input, use a shunt resistor of 250 Ω ± 0.1%.

DC voltage input or DI (on/off) input

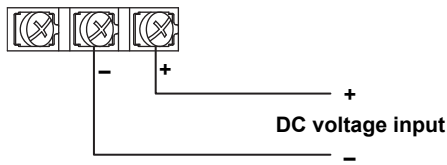

TC input

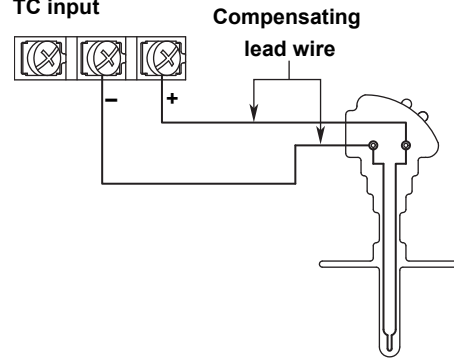

RTD input

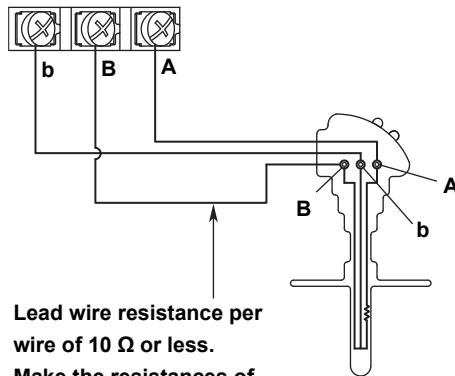

Lead wire resistance per wire of 10 Ω or less.
Make the resistances of the three wires equal.

DC current input

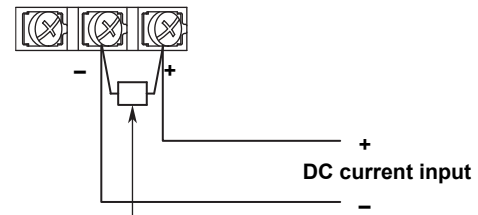

Shunt resistor
Example: For 4 to 20 mA input, use a shunt resistor of 250 $\Omega \pm 0.1\%$.

Note

RTD input terminals A and B are isolated on each channel. Terminal b is shorted internally across all channels. However, terminal b is also isolated on each channel on models with the /N2 option (3 leg isolated RTD).

12.5 Optional Terminal Wiring



WARNING

- To prevent electric shock while wiring, make sure that the power supply is turned off.
- If a voltage of more than 30 VAC or 60 VDC is to be applied to the output terminals, use ring-tongue crimp-on lugs with insulation sleeves on all terminals to prevent the signal cables from slipping out when the screws become loose. Furthermore, use double-insulated cables (dielectric strength of 3000 VAC or more) for the signal cables on which a voltage of 30 VAC or 60 VDC or more is to be applied. For all other signal cables, use basic insulated cables (dielectric strength of 1500 VAC). To prevent electric shock, attach the terminal cover after wiring and make sure not to touch the terminals.

CAUTION

- Use the following circuit voltages for the connection to the alarm/FAIL/status output terminal.
 - When the connection is to Mains Circuits (primary power supply circuits): 150 V or less
 - When the connection is to circuits derived from Mains Circuits (secondary power supply circuits): 250 V or less (Keep the Mains Circuit voltage at 300 V or less, and use an isolation transformer.)
- To prevent fire, use signal cables with a temperature rating of 70°C or more.
- Applying a strong tension to the input and output signal cables connected to the FX may damage the cables or the FX terminals. To avoid applying tension directly to the terminals, fix all cables to the rear of the mounting panel.
- Do not short the transmitter power supply output terminal or apply external voltage to it. Doing so may damage the instrument.
- When using the transmitter power supply output terminal, do not use current that is equal to or greater than the maximum output current (25 mADC). Doing so may damage the instrument.

Note

For remote control wiring, use shielded wires to reduce noise. Connect the shield to the functional ground terminal or the ground terminal of the FX.

Precautions to Be Taken While Wiring

We recommend that you use crimp-on lugs (designed for 3 mm screws) with insulation sleeves to connect to the optional terminals.



Crimp-on lug (designed for 3 mm screws) with an insulation sleeve

Wiring Procedure

As shown in the figure on the next page, the optional terminal block is located on the rear panel. The optional terminal block is only available when one of the following options, which require I/O, is installed in the FX.

Alarm output relay (/A[] or /A4A), FAIL/status output relay (/F1), remote control function (/R1), 24 V transmitter power supply output (/TPS[]), pulse input (/PM1), power monitor (/PWR1, /PWR5), or communication interface (/C3)

Dedicated cover is attached to the optional terminal block.

1. Turn off the recorder and remove the terminal cover.
2. Connect the signal cables to the terminals. The recommended torque for tightening the screws is 0.5 N•m.
3. Replace the terminal cover.

Arrangement of the Optional Terminals

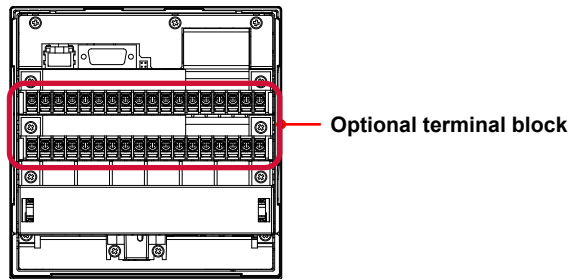

12.5 Optional Terminal Wiring

The following figures show the terminal positions for each option when only that option is installed. Even if you have installed a number of options, the individual terminal positions of the options do not change (except for the case where you have installed both the /TPS2 and /A1 options; in this case, the /A1 terminal positions are different).

NC Symbols such as “NC” indicate the terminal functions.

Alarm output, FAIL, Status

NC: Normally closed
C: Common
NO: Normally opened

Remote control input

1 to 8: Remote control terminal number
C: Common

Pulse input
H and L

Transmitter power supply output
+ and -

A terminal that is not used.

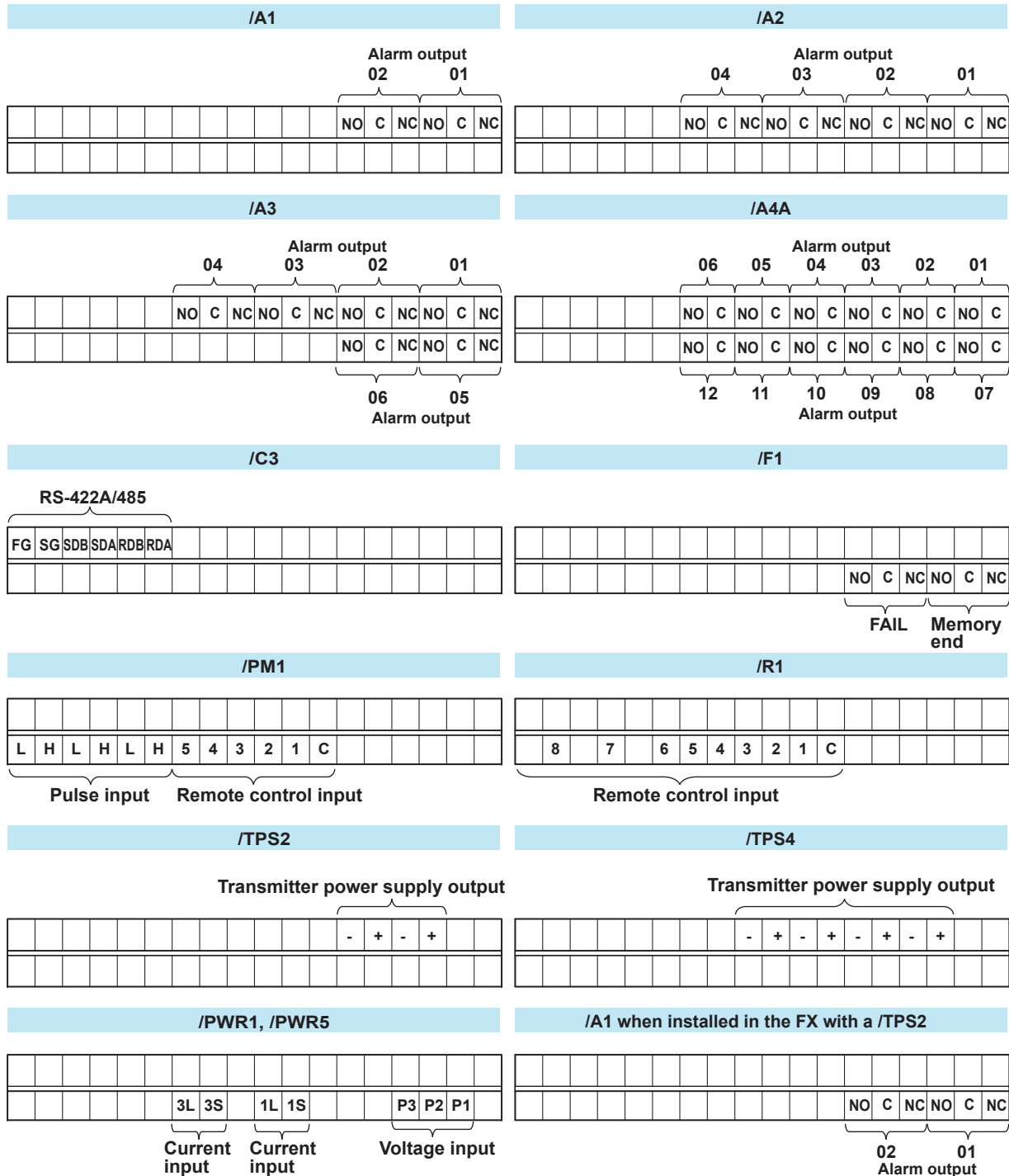

Alarm Output Terminal (/A1, /A2, and /A3), FAIL Output Terminal and Memory End Output Terminal (/F1)

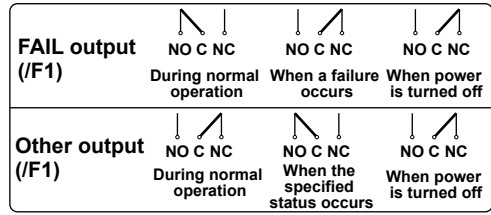
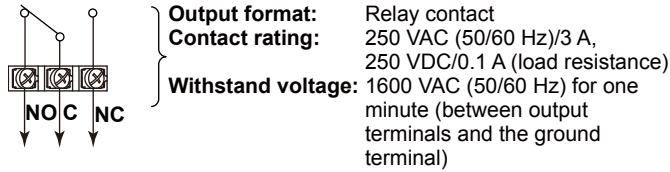

Alarm Output Terminal (/A4A)

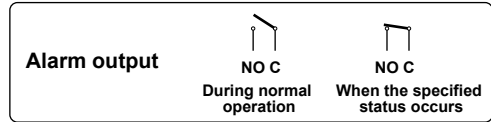
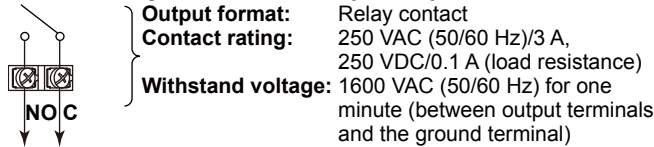

Remote Control Input Terminal (/R1)

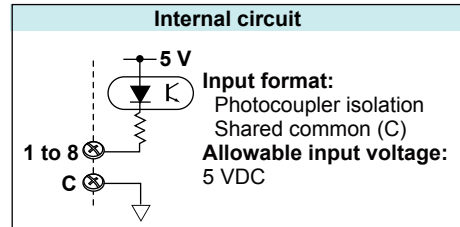
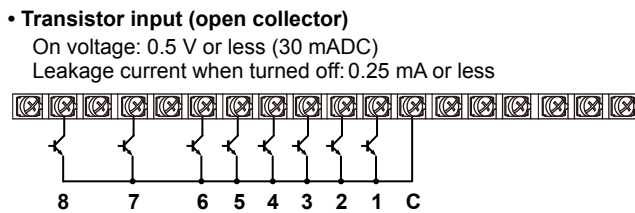
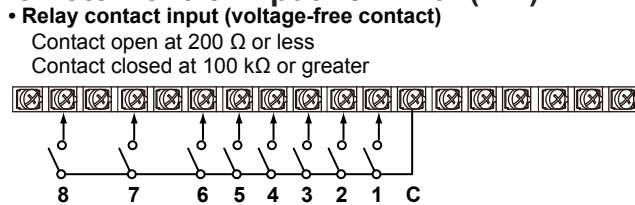

Withstand voltage: 1000 VDC for one minute between input terminals and the ground terminal

Pulse Input Terminal (/PM1)

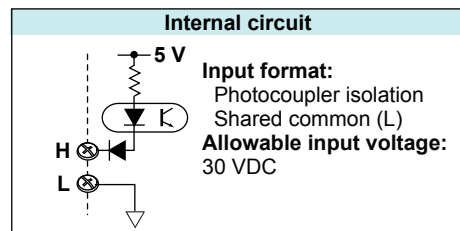
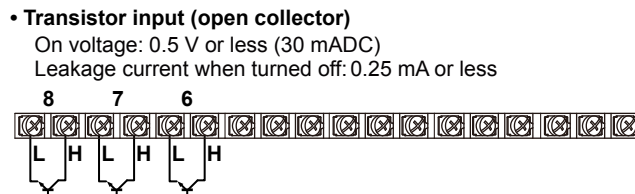
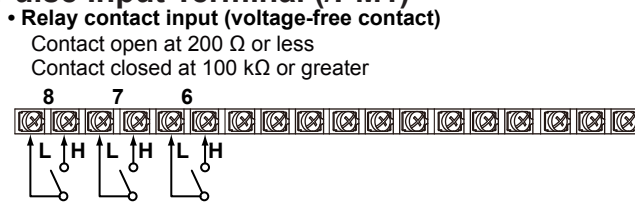

Withstand voltage: 1000 VDC for one minute between input terminals and the ground terminal

24 VDC Transmitter Power Supply Output Terminal (/TPS2, /TPS4)

Connect the FX to the transmitter as shown below.

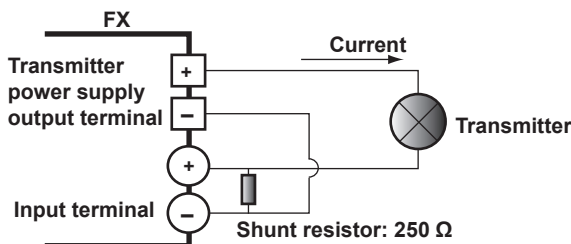

Note _____
 To reduce noise, use a shielded cable for wiring. Connect the shield to the ground terminal of the FX.

12.5 Optional Terminal Wiring

Serial Communication Interface (/C2 and /C3)

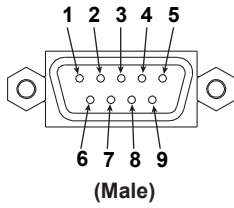

Connecting to the RS-232 Connector (/C2)

2	RD (Received Data)	Data received from the PC. Input signal to the FX.
3	SD (Send Data)	Data transmitted to the PC. Output signal from the FX.
5	SG (Signal Ground)	Signal ground.
7	RS (Request to Send)	Handshaking signal when receiving data from the PC. Output signal from the FX.
8	CS (Clear to Send)	Handshaking signal when transmitting data to the PC. Input signal to the FX.

* Pins 1, 4, 6, and 9 are not used.

Connecting to the RS-422A/485 Connector (/C3)

Four-wire system

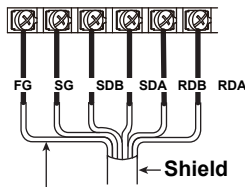

Electric potential of the shield

Two-wire system

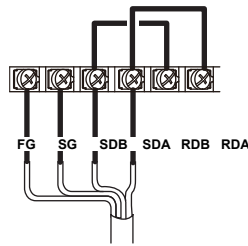

FG (Frame Ground)	Case ground of the FX
SG (Signal Ground)	Signal ground
SDB (Send Data B)	Send data B (+)
SDA (Send Data A)	Send data A (-)
RDB (Received Data B)	Receive data B (+)
RDA (Received Data A)	Receive data A (-)

Recommended length of stripped wire: 9 mm. Recommended tightening torque: 0.4 to 0.5 N·m

Cable

There are two types of cables available: the four-wire cable and the two-wire cable, which is used only for the Modbus protocol.

The cable must meet the following specifications.

- Type: Shielded twisted pair cable. 3 pairs, 24 AWG or more (four wire); 2 pairs, 24 AWG or more (two wires).
- Characteristic impedance: 100Ω
- Capacitance: 50 pF/m
- Total cable length: Up to 1.2 km

Connecting to the USB Port (/USB1)

The USB port complies with USB revision 1.1.

The USB port is installed on the FX's front panel.

Connecting to the Ethernet Port (/C7)

CAUTION

Do not connect an Ethernet cable whose plug does not comply with FCC specifications. If you do, the FX may malfunction.

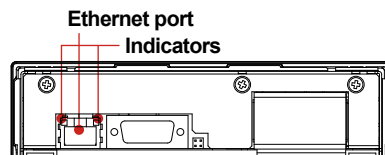

Checking the Connection and Communication Status

You can use the indicators that are located above the Ethernet port to check the connection status of the Ethernet interface.

Indicator	Connection Status of the Ethernet Interface
Illuminated (green)	The Ethernet interface is electrically connected.
Blinking (red)	Data is being transmitted.
Off	The Ethernet interface is not electrically connected.

Checking the Connection Status on the FX Display

- Checking the Connection Status in the Status Indication Section of the FX Display
You can use the Ethernet Link indicator that is located on the right side of the status indication display section of the basic setting mode display to check the connection status of the Ethernet interface. To display the basic setting mode display, press MENU to display the setting menu, and then hold down FUNC for 3 seconds or more.
- Checking the Connection Status in the Upper Right Corner of the Communication Log Display of the FX
You can use the Link indicator that is located in the upper right of the communication log display to check the connection status of the Ethernet interface.

Indicator	Connection Status of the Ethernet Interface
Illuminated (green)	The Ethernet interface is electrically connected.
Off	The Ethernet interface is not electrically connected.

Connecting to the Power Measurement Terminal (/PWR1, /PWR5)



WARNING

- To prevent electric shock while wiring, make sure that the power supply is turned off.

CAUTION

- If you are not using a VT and a CT, do not ground the input circuit.
- If you are wiring through conduits (metal tubes designed for wiring), install the CT (current transformer) inside a panel.
- Wire the voltage input and the current input within the same circuit.

Single-phase two-wire system

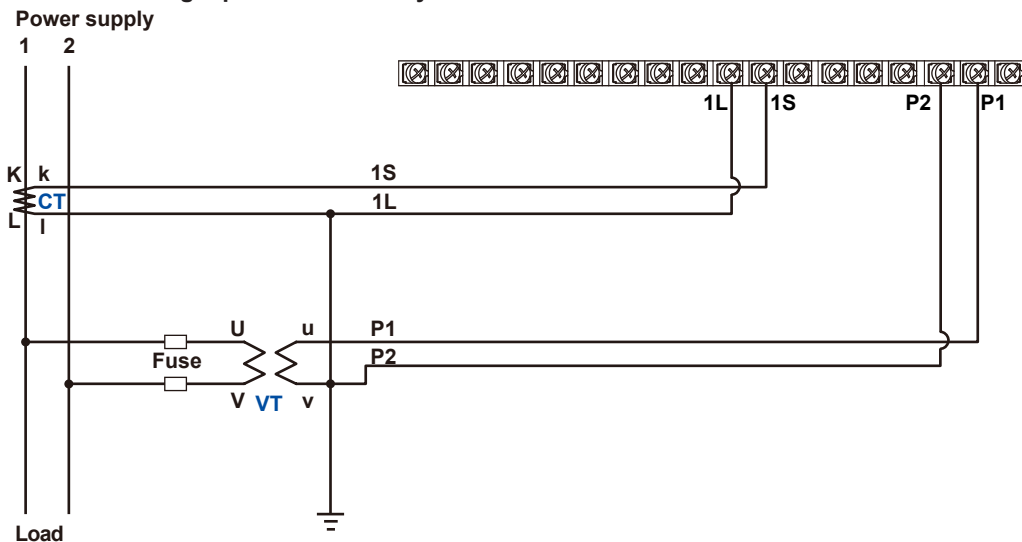

12.5 Optional Terminal Wiring

Single-phase three-wire system

For a single-phase three-wire system, connect wires to the terminal block as follows.

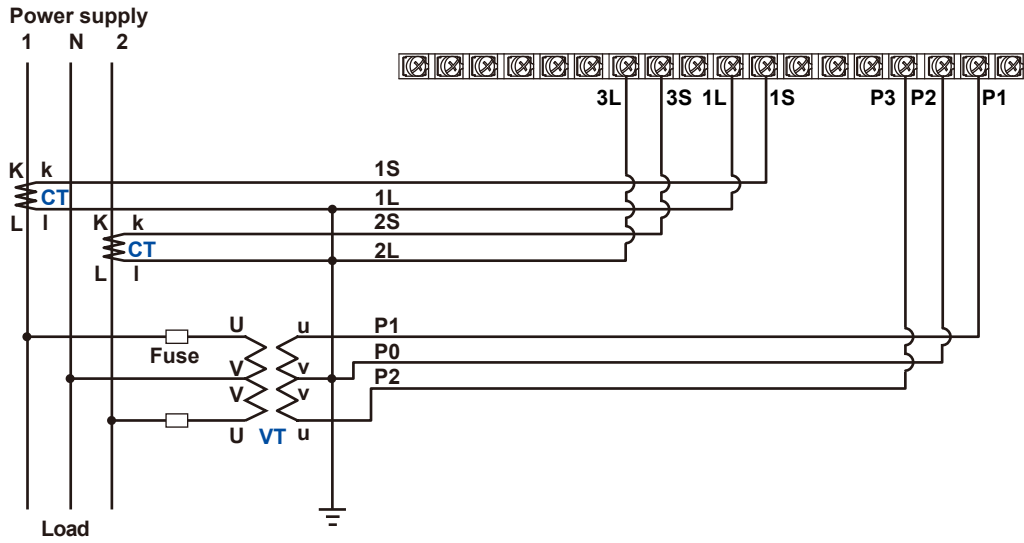

Three-phase three-wire system

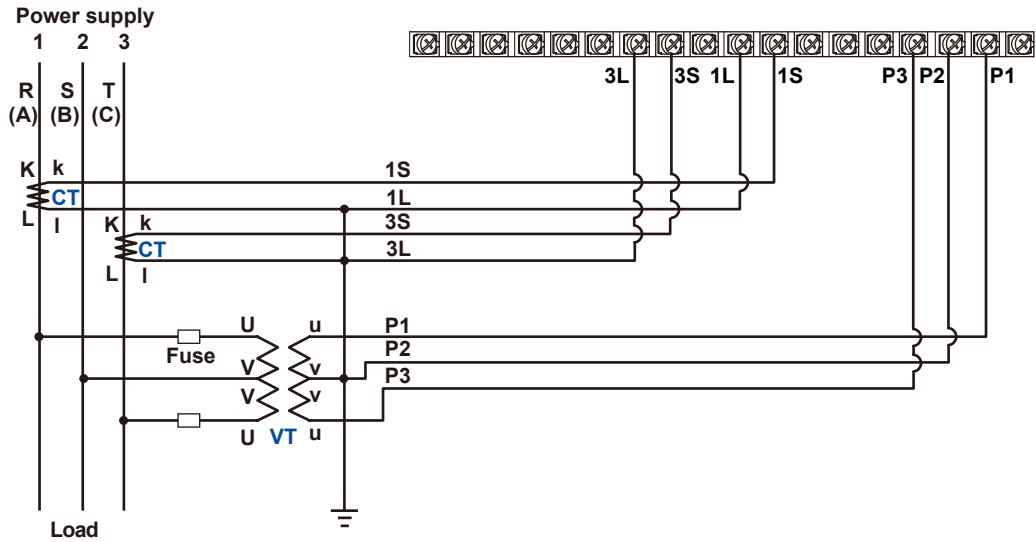

12.6 Wiring the Power Supply

Precautions to Be Taken While Wiring the Power Supply

Make sure to follow the warnings below when wiring the power supply. Failure to do so may cause electric shock or damage to the instrument.



WARNING

- To prevent electric shock, ensure that the power supply is turned off.
- To prevent fire, use 600 V PVC insulated wires (AWG20 to AWG16; JISC3307) or wires or cables with equivalent or better performance.
- Make sure to earth ground the protective earth terminal through a grounding resistance of 100 Ω or less before you turn on the power.
- Use crimp-on lugs (designed for 4 mm screws) with insulation sleeves to connect both the power cord and the protective ground.



Crimp-on lug (designed for 4 mm screws) with an insulation sleeve

- To prevent electric shock, be sure to close the transparent cover for the power supply wires.
- Provide a power switch (double-pole type) on the power supply line to separate the FX from the main power supply. Use labels to indicate that this switch is for cutting off the power supply to the FX and to indicate ON and OFF.

Switch specifications

Steady-state current rating: 1 A or more (other than /P1); 3 A or more (/P1)

Inrush current rating: 60 A or more (other than /P1); 70 A or more (/P1)

Use a switch that complies with IEC60947-1 and IEC60947-3.

- Connect a fuse (between 2 A and 15 A) to the power supply line.
- Do not add a switch or fuse to the ground line.

Use a power supply that meets the following conditions:

Item	Condition (Other than /P1)	Condition (/P1)
Rated supply voltage	100 to 240 VAC	24 VDC/AC
Allowable power supply voltage range	90 to 264 VAC	21.6 to 26.4 VDC/AC
Rated power supply frequency	50/60 Hz	50/60 Hz (for AC)
Allowable power supply frequency range	50/60 Hz \pm 2%	50/60 Hz \pm 2% (for AC)
Maximum power consumption	35 VA (100 V), 45 VA (240 V)	18 VA (for DC), 30 VA (for AC)

Note

Do not use a supply voltage of 132 to 180 VAC, as this may have adverse effects on the measurement accuracy.

12.6 Wiring the Power Supply

Wiring Procedure

1. Turn off the FX power supply, and then remove the transparent power supply terminal cover.
2. Connect the power cord and the protective ground cord to the power supply terminal. Use ring-tongue crimp-on lugs (designed for 4 mm screws) with insulation sleeves. The appropriate tightening torque for the screws is 1.4 to 1.5 N•m.

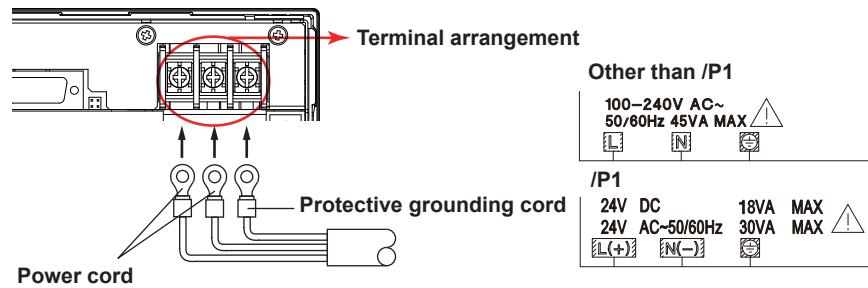

3. Attach the transparent power supply terminal cover.

13.1 Signal Input and Alarms

Measurement Input

Item Specifications

Number of inputs, scan interval, and A/D integration time

Model	No. of Measurement Channels	Scan Interval	A/D converter integration time
FX1002	2	125 ms, 250 ms	AUTO ¹ , 50 Hz, 60 Hz
FX1004	4		
FX1006	6		
FX1008	8	1 s, 2 s, 5 s	AUTO ¹ , 50 Hz, 60 Hz, 100 ms ²
FX1010	10		
FX1012	12		

- 1 AUTO: The FX automatically switches between 50 Hz and 60 Hz depending on the power supply frequency.
- 2 You can only set the integration time to 100 ms on models FX1006 through FX1012. If you set the integration time to 100 ms, you can only set the scan interval to 2 or 5 seconds.

Input Type DC voltage, 1-5V, thermocouple (TC), resistance temperature detector (RTD), ON/OFF input (DI), and DC current (by adding an external shut resistor)

Measurement range and measurable range

Input Type	Range	Measurable Range	
DC voltage	20 mV	-20.000 to 20.000 mV	
	60 mV	-60.00 to 60.00 mV	
	200 mV	-200.00 to 200.00 mV	
	1 V	-1.0000 to 1.0000 V	
	2 V	-2.0000 to 2.0000 V	
	6 V	-6.000 to 6.000 V	
	20 V	-20.000 to 20.000 V	
	50 V	-50.00 to 50.00 V	
1-5V	1 to 5 V ⁶	0.800 to 5.200 V	
Thermocouple	R ¹	0.0 to 1760.0°C	32.0 to 3200.0°F
	S ¹	0.0 to 1760.0°C	32.0 to 3200.0°F
	B ¹	0.0 to 1820.0°C	32.0 to 3308.0°F
	K ¹	-200.0 to 1370.0°C	-328.0 to 2498.0°F
	E ¹	-200.0 to 800.0°C	-328.0 to 1472.0°F
	J ¹	-200.0 to 1100.0°C	-328.0 to 2012.0°F
	T ¹	-200.0 to 400.0°C	-328.0 to 752.0°F
	N ¹	-270.0 to 1300.0°C	-454.0 to 2372.0°F
	W ²	0.0 to 2315.0°C	32.0 to 4199.0°F
	L ³	-200.0 to 900.0°C	-328.0 to 1652.0°F
	U ³	-200.0 to 400.0°C	-328.0 to 752.0°F
	WRe ⁴	0.0 to 2400.0°C	32.0 to 4352.0°F
RTD	Pt (Pt100) ⁵	-200.0 to 600.0°C	-328.0 to 1112.0°F
	JPt(JPt100) ⁵	-200.0 to 550.0°C	-328.0 to 1022.0°F
DI	Level	0: Less than 2.4 V. 1: 2.4 V or higher (judged at the 6 V range)	
	Contact ⁷	0: Open. 1: Closed (parallel capacitance of 0.01 μF or less)	

1 R, S, B, K, E, J, T, N: IEC 60584-1, DIN EN 60584-1, JIS C1602

2 W: W-5%Re/W-26%Re (Hoskins Mfg. Co.), ASTM E988

3 L: Fe-CuNi, DIN 43710, U: Cu-CuNi, DIN 43710

4 WRe: W-3%Re/W-25%Re (Hoskins Mfg. Co.)

5 Pt100: JIS C 1604, IEC 60751, DIN EN 60751

JPt100: JIS C1604, JIS C1606. Measuring current $i = 1$ mA (Pt100, JPt100).

6 The range for linear scaling of 1-5V inputs. Burnout detection and low-cut functions are available.

7 The detected current value is approximately 10 μA.

13.1 Signal Input and Alarms

Item	Specifications
Thermocouple burnout	Burnout upscale/downscale selectable (for each channel). Normal: 2 k Ω or less, Burnout: 100 k Ω or more (parallel capacitance of 0.01 μ F or less) Detection current: Approx. 10 μ A
1-5 range burnout	Burnout upscale/downscale selectable (for each channel). Burnout detection: Greater than "scale upper limit + 10% of scale width" (upscale), or "scale lower limit – less than 5% of scale width" (downscale)
TC reference junction compensation	Internal reference junction compensation or external reference junction compensation
Filter function	Takes the moving average of the input values (for each channel). Moving average data points: 2 to 400
Computation	
Difference computation	Computable range: DC voltage, TC, RTD, and DI
Linear scaling	Computable range: DC voltage, TC, RTD, and DI Scalable range: –30000 to 30000. The decimal place is within 4 digits to the right of the decimal point. Unit: Up to 6 characters in length Over value detection: The value can be set to over value when \pm 5% of the scale range is exceeded.
Square root computation	Takes the square root of the input and apply linear scaling Computable type: DC voltage Scalable range and unit: Same as linear scaling Low-cut: Set the low-cut value in the range of 0.0% to 5.0% of the span. Over value detection: Same as linear scaling
1-5V	Computable range: 1 to 5 V Scalable range and unit: Same as linear scaling Low-cut: The low-cut point is fixed to the span lower limit. Over value detection: Same as linear scaling

Alarms

Item	Specifications
Number of alarms	Up to 4 alarms (levels) per measurement channel
Alarm type	High limit, low limit, difference high limit, difference low limit, high limit on rate-of-change alarm, low limit on rate-of-change alarm, delay high limit, and delay low limit
Alarm delay time	1 to 3600 s (for each channel)
Rate-of-change calculation interval of rate-of-change alarms	1 to 32 times the scan interval (common to all channels)
Alarm output	Output to the internal switch Number of internal switches: 30 Internal switch operation: AND/OR operation selectable
Hysteresis	High and low limit alarm: 0.0 to 5.0% of the span (common to all channels) Difference high and low limit alarms: 0.0 to 5.0% of the span (common to all channels)
Display	Displays the status on the respective operation screen and an alarm icon on the status display section when an alarm occurs. Display operation: Hold or not hold the display until the alarm acknowledge operation.
Alarm hide function (alarm no logging function)	Not display alarms nor record to the alarm summary (for each channel)
Alarm information	Displays a log of alarm occurrences on the alarm summary.

13.2 Display

Display

Item	Specifications
Display*	5.7-inch TFT color LCD (240 × 320 dots)
Brightness	8 levels
Backlight saver function	Dim or turn off the LCD backlight if there is no key operation for a specified time.

* A section of the LCD monitor may contain pixels that are always on or off. The brightness of the LCD may also not be uniform due to the characteristics of the LCD. This is not a malfunction.

Displayed Information

Item	Specifications
Display groups	Assign channels to groups on the trend display, digital display, and bar graph display and display.
Number of groups	10
Number of channels that can be assigned to each group	Up to six
Display color	Channel: Select from 24 colors Background: White or black (excludes the Overview display). See the item on the Historical trend display for information on that display.)
Trend display	
Waveform line width	Select from 1, 2, and 3 dots
Display method	Orthogonal axis display with time axis (T) and measured value axis (Y) Layout: Vertical, horizontal, or wide Trend intervals: 15 s, 30 s, 1 min, 2 min, 5 min, 10 min, 15 min, 20 min, 30 min, 1 h, 2 h, 4 h, or 10 h/div for the FX1002 and FX1004. 30 s, 1 min, 2 min, 5 min, 10 min, 15 min, 20 min, 30 min, 1 h, 2 h, 4 h, or 10 h/div for the FX1006, FX1008, FX1010, and FX1012. Switchable to the secondary trend interval.
Scale	Display a scale for each channel. Current value bar graph, color scale band, and alarm point marks can be displayed on the scale.
Others	Grid (divisions: 4 to 12), trip line (line width: 1, 2, or 3 dots), message, zone display, and partial expanded display
Digital Display	Displays measured values numerically
Update rate	1 s (scan interval if the scan interval is greater than 1 s)
Bar graph display	Displays the measured value on a bar graph
Direction	Vertical or horizontal
Base position	End or center
Update rate	1 s (scan interval if the scan interval is greater than 1 s)
Scale	Display a scale for each channel Color scale band, and alarm point marks can be displayed on the scale.
Historical trend display	Redisplays the display data or event data in the internal memory or external storage medium ¹
Display formats	All screen or half screen (only when the display data is being redisplayed)
Time axis operation	The time axis can be reduced or expanded, and data can be displayed continuously.
Add message	Messages can be added.
Background color	Select from white, cream, black, or light gray.
Overview Display	Displays the measured values of all channels and the alarm statuses.

1 On FXs that have a CF card slot/SD card slot or USB interface (/USB1 option)

13.2 Display

Item	Specifications
Information display	
Alarm summary display	Displays a log of up to 1000 alarms. Specify an alarm with the cursor and jump to the corresponding section on the historical trend display.
Message summary display	Time and content of up to 450 messages (including 50 add messages) Specify a message with the cursor and jump to the corresponding section on the historical trend display.
Memory summary display	Displays the information of the data in the memory. Specify a file with the cursor and jump to the corresponding section on the historical trend display. Save the data in the internal memory to the external storage medium* using keys. * On FXs that have a CF card slot/SD card slot or USB interface (/USB1 option)
Report (/M1, /PM1, /PWR1, and /PWR5)	Displays report data from the internal memory
Stacked bar graph (/M1, /PM1, /PWR1, and /PWR5)	Displays the report data of each report group in a stacked bar graph. However, only channels that have the same unit of measurement as the first channel in the group are displayed. Display formats: H+D (hourly data is used for the display), Day+Week (daily data is used for the display), D+M (daily data is used for the display) Report groups: Report channels are arranged in groups of six starting with the first report channel (R01). The group arrangements are fixed. Scale/grid: Fixed at four divisions Update interval: 1 s
Status Display	Relay status display: Displays the ON/OFF status of the alarm output relay and internal switch. Modbus client status (/C7): Displays the communication status on the Modbus client Modbus master status (/C2, /C3): Displays the communication status on the Modbus master
Log display	Displays the login log, error log, communication log (/C2, /C3, and /C7), FTP log (/C7), Web log (/C7), e-mail log (/C7), SNMP log (/C7), and DHCP log (/C7)
System information display	Displays the number of measurement and computation channels, options, MAC address, firmware version, and internal memory capacity.
Network information display (/C7)	Displays the FX network setup information

Other Displayed Information

Item	Specifications
Tag display	Tag Up to 16 characters Displayable characters: Alphanumeric, katakana, hiragana, Hangul, Cyrillic, kanji, and Simplified Chinese characters.
Message	Write messages to the trend display.
Number of messages	100
Maximum number of saved messages	400
Character	Up to 32 characters (alphanumeric, katakana, hiragana, Hangul, kanji, and Simplified Chinese characters)
Write method	Write a preset message or write an arbitrary message on the spot.
Write destination	Select only the displayed group or all groups.
Auto message	Write a message when the FX recovers from a power failure while memory sampling is in progress. Write a message when the trend interval is switched during memory sampling.
Add message	Write messages to the past data positions.
Message	The same as the "Message" item above
Maximum number of saved messages	50
Status display section	Displays the FX status in the upper part of the display
Displayed contents	Year, month, day, time, displayed group name/display name, user name (when the login function is in use), batch name (when the batch function is in use), internal memory status, external storage medium status (on FXs with a CF card slot/SD card slot), alarm status, and function usage status (key lock, computation function (/M1, /PM1, /PWR1, /PWR5), and e-mail (/C7))
Auto switching of displayed groups	Switches the display group at a given interval. Interval: Select from the available settings between 5 s and 1 min.
Default display	Specify the display to be shown automatically when keys are not operated. Time until the display switches: Select from the available settings between 1 min and 1 h.
Display language	Selectable from English, Japanese, German, French, Chinese, Italian, Spanish, Portuguese, Russian, and Korean.
Display selection menu customization	Show/hide and change the positions of each item in the display menus and sub menus Insert/delete separators.
Function menu customization	Show/hide and change the display positions of each item.

13.3 Data Saving Function

Configuration

Item	Specifications
Internal memory	Temporarily saves various types of data.
Medium	Flash memory
External storage medium (on FXs with a CF card slot)	
Medium	CF card (32 GB Max.)
Format	FAT32 or FAT16
External storage medium (on FXs with a SD card slot)	
Medium	SD card (SD/SDHC, 32 GB Max.)
Format	FAT32 or FAT16

Data Type

Item	Specifications	
FX data types and file name extensions		
Data Type	Extension	Notes
Display data	.DAD	
Event data	.DAE	
Manual sampled data	.DAM	
Screen image data	.PNG	
Setup data	.PDL	
Report data	.DAR	/M1, /PM1, /PWR1, and /PWR5

Display Data and Event Data

Item	Specifications
Internal memory	
File storage capacity	400 MB
Number of files	Up to 400
Operation	FIFO (First In First Out)
Display data	
Target	Measurement/computation channel
Sampling intervals	Synchronized to the trend interval.
Content	Maximum or minimum value per sampling interval
Data size	Measurement channel data: 4 bytes/data value. Computation channel data: 8 bytes/data value.
File size	Up to 8 MB
Data format	Binary
Recording	Records data at all times.
Event data	
Target	Measurement/computation channel.
Sampling interval	Determined by the sample rate. 125 ms, 250 ms, 500 ms, (FX1002 and FX1004 only) 1 s, 2 s, 5 s, 10 s, 30 s, 1 min, 2 min, 5 min, or 10 min The sampling interval cannot be shorter than the scan interval.
Content	Data per sampling interval
Data size	Measurement channel data: 2 bytes/data value. Computation channel data: 4 bytes/data value.
File size	Up to 8 MB
Data format	Binary
Mode	Free: Records data at all times. Trigger: Starts recording data when a certain event occurs and records for the specified interval.
Combinations of saved data	Display data only, event data only, or display data and event data.
File size	See appendix 1.

Manual Sampled Data

Item	Specifications
Contents	Measured value at an arbitrary time
Maximum number of data values that the internal memory can store	400
Data format	Text

Report Data (/M1, /PM1, /PWR1, and /PWR5)

Item	Specifications
Contents	Report at each scheduled time of report
Maximum number of reports that the internal memory can store	100
Data format	Text

Snapshot Data

Item	Specifications
Contents	Displayed screen image data
Data format	PNG
Output destination	CF card/SD card or communication output

Saving Data to the External Storage Medium (On FXs with a CF card slot/SD card slot or the /USB1 option)

Item	Specifications
Data Saving	Saves the data in the internal memory to the external storage medium.
Manual save	Saves when the external storage medium is inserted with a key operation.
Auto save*	Display data: Every file save interval Event data: Every data length Manual sampled data: When manual sampling is executed. Report data: When report is created. Snapshot data: When a snapshot is taken
Auto save operation*	Select "save data only if there is sufficient free space on the CF card/SD card" or "constantly retain the most recent data files in the CF card/SD card (media FIFO)." * This is only valid on FXs that have a CF card slot/SD card slot.
File name	Select from "sequence number+user-assigned string+date," "sequence number+user-assigned string," or "sequence number+batch name."
Save destination	Auto save: CF card/SD card (only valid on FXs that have a CF card slot/SD card slot) Manual save: CF card/SD card or USB flash memory (/USB1) Directory name: Specify using up to 20 characters.

Setup Data (On FXs with a CF card slot/SD card slot or the /USB1 option)

Item	Specifications
Contents	FX setup data
Data format	Binary
File name	Specify using up to 32 characters.
Output/read destination (for saving/loading):	CF card/SD card or USB flash memory (/USB1)

Data File Loading (On FXs with a CF card slot/SD card slot or the /USB1 option)

Item	Specifications
Function	Load and show the display data or event data in a CF card/SD card or USB flash memory (/USB1).

Miscellaneous

Item	Specifications
Header comment	Add up to 50 characters of comment to display data, event data, manual sampled data, or report data file.

13.4 Other Standard Functions

Event Action Function

Item	Specifications
Event action	Execute a specified operation when a given event occurs.
Number of settings	40
Events	Remote control input, etc.
Timer	Number of timers: 4
Match time timer	Number of timers: 4
Action	Specify memory start/stop, alarm ACK, etc. There are limitations on the combinations of events and actions.

Security Function

Item	Specifications
Key lock function	Limitations to key operation, access to the external storage medium (on FXs with a CF card slot/SD card slot or the /USB1 option), and various operations
Login function	Only registered users can operate the FX.
System administrators	5 administrators (with total operation access)
Users	30 users (with access to operations based on their user access rights)
User access rights setting	Limitations to key operation, access to the external storage medium (on FXs with a CF card slot/SD card slot or the /USB1 option), and various operations
Automatic logout function	Users are logged out automatically if there are no key operations for the specified period of time.

Time Related Functions

Item	Specifications
Clock	With a calendar function
Accuracy	±50 ppm (0 to 50°C); does not include the delay (1 second or less) that occurs when the power is turned on
Time setting	Set by way of key operations, communication commands (/C2, /C3, and /C7), the event action function, or the SNTP client function (/C7)
Time adjustment method	
While memory sampling	Corrects the time by 40 ms for each second. Limit in which the time is gradually adjusted: Select from the available settings between 10 s and 5 min. If the time is outside the limit, the time is immediately corrected. Cannot be used after hour 0 on January 1st, 2038.
While memory is stopped	Immediately change the time.
DST	The date/time for switching between standard time and DST can be specified.
Time zone	Sets the time difference from GMT.
Date format	Select YYYY/MM/DD, MM/DD/YYYY, DD/MM/YYYY, or DD.MM.YYYY.

Types of Characters That Can Be Handled

Item	Specifications
Characters	Alphabet characters, numbers, and symbols (limitation exists)

Miscellaneous

Item	Specifications
Decimal point type	Period or comma

Batch Function

Item	Specifications
Function	Data management using batch names. Enter text fields and batch comments in the data file.
Batch name Structure	Added to the file name of the display data and event data. Batch number (up to 32 characters) + lot number (up to 8 digits)
Text field	Adds text to the display data and event data. There are 8 available text fields. Up to 20 title characters and 30 other characters can be entered per field.
Batch comment	Adds text to the display data and event data. Up to 3 comments with 50 characters or less.

13.5 Options

Alarm Output Relay (/A1, /A2, /A3, and /A4A)

Item	Specifications
Action	Outputs relay contact signals from the terminals on the rear panel when alarms occur.
Number of outputs	2 (/A1), 4 (/A2), 6 (/A3), and 12 (/A4A)
Relay contact rating	250 VAC (50/60 Hz)/3 A, 250 VDC/0.1 A (for resistance load)
Output format	2 (/A1), 4 (/A2), 6 (/A3): NO-C-NC, and 12 (/A4A): NO-C
Relay operation	Energized/deenergized, AND/OR, hold/non-hold, and reflash settings are selectable.

RS-232 Interface (/C2) and RS-422A/485 Interface (/C3)

Item	Specifications
Connection	EIA RS-232(/C2) or EIA RS-422/485(/C3)
Protocol	Dedicated protocol or Modbus protocol
Synchronization	Start-stop synchronization
Transmission mode (RS-422A/485)	Four-wire half-duplex multi-drop connection (1:N (N = 1 to 32))
Data rate	1200, 2400, 4800, 9600, 19200, or 38400 bps
Data length	7 or 8 bits
Stop bit	1 bit
Parity	Odd, even, or none
Handshaking	Off:Off, XON:XON, XON:RS, and CS:RS
Communication distance (RS-422A/485)	1200 m
Modbus master	Reading information such as measured data from other instruments and writing this information to registers
Modbus slave	Reading data from measurement and computation channels (/M1, /PM1, /PWR1, and /PWR5) Reading and writing communication input data (/M1, /PM1, /PWR1, and /PWR5) Some control commands such as memory start

Ethernet Communication Interface (/C7)

Item	Specifications
Electrical and mechanical specifications	Conforms to IEEE 802.3 (Ethernet frames conform to the DIX specification).
Medium	Ethernet (10BASE-T)
Protocol	Dedicated protocol as well as the TCP, IP, UDP, ICMP, ARP, DHCP, HTTP, FTP, SMTP, SNMP, and Modbus protocols
E-mail client	Automatically send e-mail at specified times.
FTP client	Automatically transfer the following types of data files to the FTP server: Display data, event data, snapshot data, and report data (/M1, /PM1, /PWR1, and /PWR5)
FTP Server	Moving and deleting files on the FX, managing directories, and generating file lists
Web server	Displaying the FX screen on a Web browser
SNTP client	Setting the FX time to the results of an SNTP server query Cannot be used after hour 0 on January 1st, 2036.
SNTP server	Generating the FX's time. Time resolution: 5 ms Cannot be used after hour 0 on January 1st, 2036.
DHCP client	Automatically obtain the network address settings from the DHCP server.
Modbus client	Reads data from another device and writes to the registers.
Modbus server	Reading data from measurement and computation channels (/M1, /PM1, /PWR1, and /PWR5) Reading and writing communication input data (/M1, /PM1, /PWR1, and /PWR5) Some control commands such as memory start. Modbus client access limitations.
Setting/Measurement server	Using the dedicated protocol, control and configure the FX, and generate data from the FX
Maintenance/test server	Outputs connection information and network information.
Instrument information server	Generating the information (such as the serial number and model name) of the connected FX

FAIL/Status Output Relay (/F1)

Item	Specifications
FAIL output	Relay contact output on CPU error
Relay operation	Energized during normal operation and de-energized on system error.
Status output	Output a relay contact signal when a selected condition occurs. A combination of the following conditions can be selected: Low memory, memory failure, media error, A/D hardware error, burnout detection, communication error (Modbus master or client communication error), memory sampling stop.
Relay operation	Relay is energized when a condition occurs.
Relay contact rating	250 VAC (50/60 Hz)/3 A, 250 VDC/0.1 A (for resistance load)

Computation Function (including the report function) (/M1)

Item	Specifications
Number of computation channels	FX1002 and FX1004: 12 channels (101 to 112) FX1006, FX1008, FX1010, and FX1012: 24 channels (101 to 124)
Operation	General arithmetic operations: Four arithmetic operations, square root, absolute, common logarithm, natural logarithm, exponential, and power Relational operations: <, ≤, >, ≥, =, and ≠ Logic operations: AND, OR, NOT, and XOR Statistical operations: TLOG and CLOG Special operations: PRE, HOLD, RESET, and CARRY Conditional operation: [a?b:c]
Computation accuracy	Double-precision floating point
Data that can be used	
Channel data	Measurement and computation channels
Constants	60 constants
Communication input data	24
Remote control input status	0/1 (/R1)
Pulse input	Counts the number of pulses (/PM1)
Status input	Internal switch, alarm output relay (/A[] and /A4A), flags
Rolling average	Performs moving average on the computed results.
Measurement range	–9999999 to 99999999 Decimal place: 0 to 4 digits to the right of the decimal point
Unit	Up to 6 characters in length Sum scales: Off, /s, /min, /h, /day
Alarms	High limit, low limit, delay high limit, and delay low limit Hysteresis: High and low limit alarm: 0.0% to 5.0% of the span.
Display	Same as the measurement channels
Data saving	Same as the measurement channels
Report function	Number of report channels: 12 or 24 (same as the number of computation channels) Computation types: Average, maximum, minimum, sum, or instantaneous value Report types: Hourly, daily, hourly + daily, daily + weekly, daily + monthly

3-Wire Isolated RTD Input (/N2)

Item	Specifications
Input terminal	All the RTD input terminals (A, B, and b) are isolated on each channel. Applies to the FX1006, FX1008, FX1010, and FX1012 Note: On the FX1002 and FX1004 standard models, the A, B, and b terminals are already isolated on each channel.

13.5 Options

Extended Input (/N3F)

Item	Specifications
------	----------------

Measurement/display accuracy
Under standard operating conditions

Input Type		Measuring Range	Measurement Accuracy		Max. Resolution
Thermocouple	Kp vs Au7Fe	0.0 to 300.0 K	0 to 20 K	Within ± 4.5 K	0.1 K
			20 to 300 K	Within ± 2.5 K	
	PLATINEL	0.0 to 1400.0°C	$\pm(0.25\%$ of rdg + 2.3°C)		0.1°C
	PR40-20	0.0 to 1900.0°C	0 to 450°C	Accuracy not guaranteed	
			450 to 750°C	$\pm(0.9\%$ of rdg + 3.2°C)	
			750 to 1100°C	$\pm(0.9\%$ of rdg + 1.3°C)	
			1100 to 1900°C	$\pm(0.9\%$ of rdg + 0.4°C)	
	NiNiMo	0.0 to 1310.0°C	$\pm(0.25\%$ of rdg + 0.7°C)		
	W/WRe26 ²	0.0 to 2400.0°C	0 to 400°C	± 15.0 °C	
			400 to 2400°C	$\pm(0.2\%$ of rdg + 2.0°C)	
Type N (AWG14) ³	0.0 to 1300.0°C	$\pm(0.2\%$ of rdg + 1.3°C)			
XK GOST	-200.0 to 600.0	-200 to -100°C	$\pm(0.25\%$ of rdg + 1.0°C)		
		-100 to 600°C	$\pm(0.25\%$ of rdg + 0.8°C)		
RTD ¹	Ni100 (SAMA)	-200.0 to 250.0°C	$\pm(0.15\%$ of rdg + 0.4°C)		
	Ni100 (DIN) ⁴	-60.0 to 180.0°C	$\pm(0.15\%$ of rdg + 0.4°C)		
	Ni120 ⁵	-70.0 to 200.0°C	$\pm(0.15\%$ of rdg + 0.4°C)		
	Pt100 GOST ⁶	-200.0 to 600.0°C	$\pm(0.15\%$ of rdg + 0.3°C)		
	Cu100 GOST ⁶	-200.0 to 200.0°C	$\pm(0.15\%$ of rdg + 0.3°C)		
	Cu50 GOST ⁷	-200.0 to 200.0°C	$\pm(0.4\%$ of rdg + 0.5°C)		
	Pt200 (WEED) ⁸	-100.0 to 450.0°C	$\pm(0.3\%$ of rdg + 0.6°C)		

1 Measuring current $i = 1$ mA

2 W/WRe26: W/W-26%Re(Hoskins Mfg.Co.) ASTM E1751

3 N(AWG14): NBS

4 Ni100 (DIN): DIN 43760

5 Ni120: McGRAW EDISON COMPANY

6 Cu100 GOST, Pt100 GOST: GOST 6651-2009

7 Cu50 GOST, Pt46 GOST: GOST 6651-94

8 Double the resistance of a 100 ohm Platinum (TCR = .003902 ohms/ohm/°C) Curve A resistor made by Weed Instrument.

Input source resistance Thermocouple input: 2 k Ω or less
RTD input: 1 Ω or less per wire (The resistance of all three wires must be equal).

Ambient temperature influence (with temperature variation of 10°C)

TC input $\pm(0.1\%$ of rdg + 0.05% of range) or less, excluding the error of reference junction compensation

RTD input $\pm(0.2\%$ of range + 2 digits) or less

Input source resistance

TC input With variation of +1 k Ω : ± 10 μ V or less

RTD input With variation of 1 Ω per wire (resistance of all three wires must be equal): $\pm(0.1\%$ of rdg + 1 digit) or less

With maximum difference of 100 m Ω between wires: Approx. 1 °C

Remote Control (/R1)

Item	Specifications
------	----------------

Number of input terminals 8

Input type Isolated from the main circuitry through a photocoupler, built-in isolated power supply for the input terminals, and shared common.

Input type and signal level

Voltage-free contact Contact closed at 200 Ω or less and contact open at 100 k Ω or greater.

Open collector ON voltage: 0.5 V or less (sink current 30 mA or more), leakage current when OFF: 0.25 mA or less

Allowable input voltage 5 VDC

Signal type Level or edge (250 ms or more)

Action Executes a specified action by applying a given signal to the remote signal input terminal.

Action assignment: Set using the event action function

24 VDC Transmitter Power Supply (/TPS2 and /TPS4)

Item	Specifications
Number of loops	2 (/TPS2) or 4 (/TPS4)
Output voltage	22.8 to 25.2 VDC (under rated load current)
Rated output current	4 to 20 mADC
Max. output current	25 mADC (overcurrent protection operation current: approx. 68 mADC)
Allowable conductor resistance	$RL \leq (17.8 - \text{minimum transmitter operation voltage})/0.02 \text{ A}$ where 17.8 V is the result obtained by subtracting the maximum drop voltage of 5 V when the load shunt resistance is 250 Ω from the minimum output voltage of 22.8 V
Max. length of wiring	2 km (when using the CEV cable)
Insulation resistance	20 M Ω or more at 500 VDC between output terminal and ground
Dielectric strength	500 VAC (50/60 Hz, I = 10mA) for one minute between output terminal and ground 500 VAC (50/60 Hz, I = 10mA) for one minute between output terminals

USB Interface (/USB1)

Item	Specifications
USB port	Complies with Rev. 1.1 and host function
Number of ports	1 (front panel)
Power supply	5 V, 500 mA
Connectable devices	Only connect the devices listed below to prevent damage to the devices.
Keyboard	Complies with HID Class Ver. 1.1 104 keyboard/89 keyboard (US) and 109 keyboard/89 keyboard (Japanese) Number connectable units: 1
External medium	USB flash memory Does not guarantee the operation of all USB flash memories. External medium such as a hard disk, ZIP, MO, and optical discs are not supported. Number connectable units: 1

Pulse Input (/PM1)

Item	Specifications
Pulse input	
Number of inputs	3 (8 when using the remote control input terminals)
Input type	Isolated from the main circuitry through a photocoupler and built-in isolated power supply for the input terminals. Shared common for pulse inputs.
Input type and signal level	Voltage-free contact Contact closed at 200 Ω or less and contact open at 100 k Ω or greater Open collector ON voltage: 0.5 V or less (sink current 30 mA or more), leakage current when OFF: 0.25 mA or less
Counting	Counts the rising edges of pulses. For voltage-free contact input: Contact open to contact close For open collector: Voltage level of the terminal H from high to low
Allowable input voltage	30 VDC
Max. sampling pulse period	100 Hz
Minimum detected pulse width	5 ms or more for both low (closed) and high (open)
Pulse detection period	Approx. 3.9 ms (256 Hz)
Pulse measuring accuracy	± 1 pulse
Pulse count interval	Scan interval or 1 s
Miscellaneous	Pulse input terminals can be used as remote control input terminals, isolated from remote control input terminals
Remote control	Number of inputs: 5. Same as remote control (/R1) for the other specifications
Computation function	Same as the computation function (/M1)

Calibration Correction (/CC1)

Item	Specifications
Calibration correction method	Corrects the measured value of each channel using segment linearizer approximation. Number of segment points: 2 to 16 (including the start and end points)

13.5 Options

DC/AC 24 V power supply (/P1)

Item	Specifications												
Rated supply voltage	24 VDC and 24 VAC (50/60Hz)												
Allowable power supply voltage range	21.6V to 26.4 VDC/AC												
Insulation resistance	Between power terminal and earth: 20 MΩ or greater at 500 VDC.												
Withstand voltage	Between power terminal and earth: 500 VAC at 50/60 Hz for one minute												
Rated power supply frequency (for AC)	50/60 Hz												
Allowable power supply frequency range (for AC)	50 Hz ±2%, 60 Hz ±2%												
Power supply fluctuation:	With variation within 21.6 to 26.4 VDC/AC: ±1 digit or less												
Power supply frequency fluctuation (for AC):	With variation of ±2 Hz from rated power supply frequency: ±(0.1% of rdg+1 digit) or less												
Rated power consumption	18 VA (for DC), 30 VA (for AC)												
Power consumption													
	<table border="1"> <thead> <tr> <th>Supply voltage</th> <th>LCD backlight off</th> <th>Normal</th> <th>Maximum</th> </tr> </thead> <tbody> <tr> <td>24 VDC</td> <td>5 VA</td> <td>7 VA</td> <td>18 VA</td> </tr> <tr> <td>24 VAC (50/60Hz)</td> <td>8 VA</td> <td>12 VA</td> <td>30 VA</td> </tr> </tbody> </table>	Supply voltage	LCD backlight off	Normal	Maximum	24 VDC	5 VA	7 VA	18 VA	24 VAC (50/60Hz)	8 VA	12 VA	30 VA
Supply voltage	LCD backlight off	Normal	Maximum										
24 VDC	5 VA	7 VA	18 VA										
24 VAC (50/60Hz)	8 VA	12 VA	30 VA										

Log Scale (/LG1)

Item	Specifications
Function	A logarithmic voltage that has been converted from a physical value is applied to the FX, and then the FX's Log scale (logarithmic scale) is used to display and record the physical value.
Input type	Log input: Logarithmic input (LogType1) Log linear input: Input that is linear on a logarithmic scale (LogType2) Pseudo log input: An input that supports pseudo logs. (LogType2) Nonlinear log input: An input that supports nonlinear logs on which calibration correction (/CC1 option) is applied. Calibration correction is performed using voltage values. (LogType1)
Range	20 mV, 60 mV, 200 mV, 2 V, 6 V, 20 V, 50 V, and 1 V
Unit	Up to 6 characters
Scalable range	<p>Log input (LogType1)</p> <p>1.00E-15 to 1.00E+15 (15 decades maximum) Lower limit mantissa range: 1.00 to 9.99. Upper limit mantissa range: 1.00 to 9.99. Scale_L < Scale_U If the lower limit mantissa is 1.00, the difference between the exponents must be 1 or more. If the lower limit mantissa is a value other than 1.00, the difference between the exponents must be 2 or more.</p> <p>Log linear input/Pseudo Log Input (LogType2)</p> <p>Lower limit mantissa range: 1.00 to 9.99. Upper limit mantissa range: N/A (the value is the same as the lower limit mantissa). If the lower limit mantissa is 1.00, the value must be between 1.00E-15 and 1.00E+15, the difference between the exponents must be 1 or more, and the maximum decades is 15. If the lower limit mantissa is a value other than 1.00, the value must be between 1.01E-15 and 9.99E+14, the difference between the exponents must be 1 or more and the maximum decades is 14.</p>
Alarm	
Kind	High limit, low limit, delay high limit, and delay low limit
Range	1.00E-16 to 1.00E+16, mantissa: 1.00 to 9.99
Hysteresis	0% (fixed)
Color scale band range	1.00E-16 to 1.00E+16, mantissa: 1.00 to 9.99 The display position lower limit must be less than the display position upper limit.
Number of mantissa display digits	2 or 3

Power Monitor (/PWR1, /PWR5)

Unless otherwise specified, the performance values listed here were recorded under the following standard operating conditions: 23 ± 2°C, 55 ± 10%RH; power supply frequency: 50/60 Hz ± 1% or less; rated input: ±1% or less, power factor: 1 ± 1% or less; warm-up time: 30 minutes or more; and a location in which oscillations and other factors do not affect the operation of the instrument.

Item	Specifications																																																																																		
Measurement element	By including power measurement elements in an expression, you can measure a variety of power values. Active power, regenerative electric power, reactive power, apparent power, voltage, current, frequency, power factor (LEAD: -, LAG: +), and electric energy (active energy, regenerative energy, reactive energy—LAG: +, reactive energy—LEAD: -, and apparent energy) * The LEAD/LAG sign is calculated from the phase difference between P1 (voltage) and I1 (current).																																																																																		
Phase and wiring system	Single-phase two-wire system, single-phase three-wire system, and three-phase three-wire system																																																																																		
Frequency	45 to 65 Hz																																																																																		
Rated input voltage	<table border="1"> <thead> <tr> <th>Rated Voltage</th> <th>Voltage Range (Variable)</th> <th>Allowable Input Voltage</th> <th>Crest Factor</th> </tr> </thead> <tbody> <tr> <td>120 V</td> <td>120 V</td> <td>150 V</td> <td>2</td> </tr> <tr> <td>240 V</td> <td>240 V</td> <td>300 V</td> <td>2</td> </tr> </tbody> </table>	Rated Voltage	Voltage Range (Variable)	Allowable Input Voltage	Crest Factor	120 V	120 V	150 V	2	240 V	240 V	300 V	2																																																																						
Rated Voltage	Voltage Range (Variable)	Allowable Input Voltage	Crest Factor																																																																																
120 V	120 V	150 V	2																																																																																
240 V	240 V	300 V	2																																																																																
Rated input current	<table border="1"> <thead> <tr> <th>Option</th> <th>Rated Current</th> <th>Current Range (Fixed)</th> <th>Allowable Input Current</th> <th>Crest Factor</th> </tr> </thead> <tbody> <tr> <td>/PWR1</td> <td>1 A</td> <td>1 A</td> <td>1.2 A</td> <td>2</td> </tr> <tr> <td>/PWR5</td> <td>5 A</td> <td>5 A</td> <td>6 A</td> <td>2</td> </tr> </tbody> </table>	Option	Rated Current	Current Range (Fixed)	Allowable Input Current	Crest Factor	/PWR1	1 A	1 A	1.2 A	2	/PWR5	5 A	5 A	6 A	2																																																																			
Option	Rated Current	Current Range (Fixed)	Allowable Input Current	Crest Factor																																																																															
/PWR1	1 A	1 A	1.2 A	2																																																																															
/PWR5	5 A	5 A	6 A	2																																																																															
Allowable input range	150 Vrms (when the voltage range is set to 120 V), 300 Vrms (when the voltage range is set to 240 V), and 1.2 A (when using current input)																																																																																		
Rated input power and measuring range	<p>Single-phase two-wire system</p> <table border="1"> <thead> <tr> <th rowspan="2">Option</th> <th colspan="2">Input (AC)</th> <th rowspan="2">Input Measuring Range¹</th> <th colspan="2">Approximate Consumed VA</th> </tr> <tr> <th></th> <th>Rated Power</th> <th>Voltage</th> <th>Current</th> </tr> </thead> <tbody> <tr> <td rowspan="2">/PWR1</td> <td>120 V/1 A</td> <td>100 W</td> <td>-120 to 120 W</td> <td>0.2 VA</td> <td rowspan="2">0.2 VA</td> </tr> <tr> <td>240 V/1 A</td> <td>200 W</td> <td>-240 to 240 W</td> <td>0.4 VA</td> </tr> <tr> <td rowspan="2">/PWR5</td> <td>120 V/5 A</td> <td>500 W</td> <td>-600 to 600 W</td> <td>0.2 VA</td> <td rowspan="2">0.2 VA</td> </tr> <tr> <td>240 V/5 A</td> <td>1000 W</td> <td>-1200 to 1200 W</td> <td>0.4 VA</td> </tr> </tbody> </table> <p>Single-phase three-wire system</p> <table border="1"> <thead> <tr> <th rowspan="2">Option</th> <th colspan="2">Input (AC)</th> <th rowspan="2">Input Measuring Range</th> <th colspan="2">Approximate Consumed VA</th> </tr> <tr> <th></th> <th>Rated Power</th> <th>Voltage</th> <th>Current</th> </tr> </thead> <tbody> <tr> <td>/PWR1</td> <td>200 V/1 A</td> <td>200 W</td> <td>-240 to 240 W</td> <td>0.2 VA/phase</td> <td>0.2 VA/phase</td> </tr> <tr> <td>/PWR5</td> <td>200 V/5 A</td> <td>1000 W</td> <td>-1200 to 1200 W</td> <td>0.2 VA/phase</td> <td>0.2 VA/phase</td> </tr> </tbody> </table> <p>Three-phase three-wire system</p> <table border="1"> <thead> <tr> <th rowspan="2">Option</th> <th colspan="2">Input (AC)</th> <th rowspan="2">Input Measuring Range</th> <th colspan="2">Approximate Consumed VA</th> </tr> <tr> <th></th> <th>Rated Power</th> <th>Voltage</th> <th>Current</th> </tr> </thead> <tbody> <tr> <td rowspan="2">/PWR1</td> <td>120 V/1 A</td> <td>200 W</td> <td>-240 to 240 W</td> <td>0.2 VA/phase</td> <td rowspan="2">0.2 VA/phase</td> </tr> <tr> <td>240 V/1 A</td> <td>400 W</td> <td>-480 to 480 W</td> <td>0.4 VA/phase</td> </tr> <tr> <td rowspan="2">/PWR5</td> <td>120 V/5 A</td> <td>1000 W</td> <td>-1200 to 1200 W</td> <td>0.2 VA/phase</td> <td rowspan="2">0.2 VA/phase</td> </tr> <tr> <td>240 V/5 A</td> <td>2000 W</td> <td>-2400 to 2400 W</td> <td>0.4 VA/phase</td> </tr> </tbody> </table> <p>The input measuring range when you are using a VT and CT is calculated using the following equation. The measuring range must be within the input measuring ranges listed above, and the primary side input power² must be less than 10 GW.</p> <ol style="list-style-type: none"> Input measuring range (W) = Primary side input power² in W/(VT ratio × CT ratio). Primary side input power = Secondary side rated power in W × 1.2 × VT ratio × CT ratio. <p>Power factor: (LEAD) 0.5 to 1 to (LAG) 0.5 Frequency: 45 to 65 Hz</p>	Option	Input (AC)		Input Measuring Range ¹	Approximate Consumed VA			Rated Power	Voltage	Current	/PWR1	120 V/1 A	100 W	-120 to 120 W	0.2 VA	0.2 VA	240 V/1 A	200 W	-240 to 240 W	0.4 VA	/PWR5	120 V/5 A	500 W	-600 to 600 W	0.2 VA	0.2 VA	240 V/5 A	1000 W	-1200 to 1200 W	0.4 VA	Option	Input (AC)		Input Measuring Range	Approximate Consumed VA			Rated Power	Voltage	Current	/PWR1	200 V/1 A	200 W	-240 to 240 W	0.2 VA/phase	0.2 VA/phase	/PWR5	200 V/5 A	1000 W	-1200 to 1200 W	0.2 VA/phase	0.2 VA/phase	Option	Input (AC)		Input Measuring Range	Approximate Consumed VA			Rated Power	Voltage	Current	/PWR1	120 V/1 A	200 W	-240 to 240 W	0.2 VA/phase	0.2 VA/phase	240 V/1 A	400 W	-480 to 480 W	0.4 VA/phase	/PWR5	120 V/5 A	1000 W	-1200 to 1200 W	0.2 VA/phase	0.2 VA/phase	240 V/5 A	2000 W	-2400 to 2400 W	0.4 VA/phase
Option	Input (AC)		Input Measuring Range ¹	Approximate Consumed VA																																																																															
		Rated Power		Voltage	Current																																																																														
/PWR1	120 V/1 A	100 W	-120 to 120 W	0.2 VA	0.2 VA																																																																														
	240 V/1 A	200 W	-240 to 240 W	0.4 VA																																																																															
/PWR5	120 V/5 A	500 W	-600 to 600 W	0.2 VA	0.2 VA																																																																														
	240 V/5 A	1000 W	-1200 to 1200 W	0.4 VA																																																																															
Option	Input (AC)		Input Measuring Range	Approximate Consumed VA																																																																															
		Rated Power		Voltage	Current																																																																														
/PWR1	200 V/1 A	200 W	-240 to 240 W	0.2 VA/phase	0.2 VA/phase																																																																														
/PWR5	200 V/5 A	1000 W	-1200 to 1200 W	0.2 VA/phase	0.2 VA/phase																																																																														
Option	Input (AC)		Input Measuring Range	Approximate Consumed VA																																																																															
		Rated Power		Voltage	Current																																																																														
/PWR1	120 V/1 A	200 W	-240 to 240 W	0.2 VA/phase	0.2 VA/phase																																																																														
	240 V/1 A	400 W	-480 to 480 W	0.4 VA/phase																																																																															
/PWR5	120 V/5 A	1000 W	-1200 to 1200 W	0.2 VA/phase	0.2 VA/phase																																																																														
	240 V/5 A	2000 W	-2400 to 2400 W	0.4 VA/phase																																																																															
Measuring range																																																																																			

13.5 Options

Item	Specifications														
Measurement accuracy	<p>The performance values listed here were recorded under the following standard operating conditions: 23 ± 2°C, 55 ± 10%RH; power supply frequency: 50/60 Hz ± 1% or less; rated input: ± 1% or less, power factor: 1 ± 1% or less; warm-up time: 30 minutes or more; and a location in which vibrations and other factors do not affect the operation of the instrument.</p> <p>Active power (W): ±1.0% of range (/PWR1), ±0.5% of range (/PWR5) Voltage (V): ±1.0% of range (/PWR1), ±0.5% of range (/PWR5) Current (A): ±1.0% of range (/PWR1), ±0.5% of range (/PWR5) Apparent power, reactive power, and power factor: Value calculated from the measured values ± 1 digit</p> <p>Expressions (V and A are rms values)</p> <table border="1"> <thead> <tr> <th></th> <th>Apparent Power (VA)</th> <th>Reactive Power (Q) (Without using the reactive power measurement method)</th> <th>Power Factor(PF)</th> </tr> </thead> <tbody> <tr> <td>Single-phase two-wire system</td> <td>$VA = V \times A$</td> <td>$Q = \sqrt{((VA)^2 - P^2)}$</td> <td rowspan="3">$\Sigma P / \Sigma VA$ (Without using the reactive power measurement method)</td> </tr> <tr> <td>Single-phase, three-wire system</td> <td>$VA_i = V_i \times A_i$ $i = 1, 2$ $\Sigma VA = VA_1 + VA_2$</td> <td>$Q_i = \sqrt{((VA_i)^2 - P_i^2)}$ $i = 1, 2$ $\Sigma Q = Q_1 + Q_2$</td> </tr> <tr> <td>Three-phase three-wire system</td> <td>$VA_i = V_i \times A_i$ $i = 1, 3$ $\Sigma VA = \sqrt{3}/2(VA_1 + VA_3)$</td> <td>$Q_i = \sqrt{((VA_i)^2 - P_i^2)}$ $i = 1, 3$ $\Sigma Q = Q_1 + Q_3$</td> </tr> </tbody> </table> <p>* The FX's apparent power (VA), reactive power (Q), power factor (PF), and phase (deg) are determined from the voltage(V), current(A), and active power(P) by means of digital computations. Therefore, for distorted signal input, the value obtained on the FX may differ from that obtained on other instruments that use a different method.</p> <p>* Make sure that the voltage input is at least 10% of the rated value and the current input is at least 5% of the rated value.</p> <p>* In the ΣQ computation, each phase's Q value is computed as negative (-) if the current input is leading the voltage input and as positive (+) if the current input is lagging the voltage input.</p> <p>Frequency: ±1.0 Hz * The frequency of the voltage line input to voltage P1 is output in units of Hz.</p>		Apparent Power (VA)	Reactive Power (Q) (Without using the reactive power measurement method)	Power Factor(PF)	Single-phase two-wire system	$VA = V \times A$	$Q = \sqrt{((VA)^2 - P^2)}$	$\Sigma P / \Sigma VA$ (Without using the reactive power measurement method)	Single-phase, three-wire system	$VA_i = V_i \times A_i$ $i = 1, 2$ $\Sigma VA = VA_1 + VA_2$	$Q_i = \sqrt{((VA_i)^2 - P_i^2)}$ $i = 1, 2$ $\Sigma Q = Q_1 + Q_2$	Three-phase three-wire system	$VA_i = V_i \times A_i$ $i = 1, 3$ $\Sigma VA = \sqrt{3}/2(VA_1 + VA_3)$	$Q_i = \sqrt{((VA_i)^2 - P_i^2)}$ $i = 1, 3$ $\Sigma Q = Q_1 + Q_3$
	Apparent Power (VA)	Reactive Power (Q) (Without using the reactive power measurement method)	Power Factor(PF)												
Single-phase two-wire system	$VA = V \times A$	$Q = \sqrt{((VA)^2 - P^2)}$	$\Sigma P / \Sigma VA$ (Without using the reactive power measurement method)												
Single-phase, three-wire system	$VA_i = V_i \times A_i$ $i = 1, 2$ $\Sigma VA = VA_1 + VA_2$	$Q_i = \sqrt{((VA_i)^2 - P_i^2)}$ $i = 1, 2$ $\Sigma Q = Q_1 + Q_2$													
Three-phase three-wire system	$VA_i = V_i \times A_i$ $i = 1, 3$ $\Sigma VA = \sqrt{3}/2(VA_1 + VA_3)$	$Q_i = \sqrt{((VA_i)^2 - P_i^2)}$ $i = 1, 3$ $\Sigma Q = Q_1 + Q_3$													
Response time	2 seconds														
Continuous overload	Within the degree of accuracy (rated voltage and rated current × 1.2 applied for 2 hours)														
Instantaneous overload	Within the degree of accuracy (rated voltage × 1.5 applied for 10 seconds, rated current × 2 applied for 10 seconds, rated current × 10 applied for 3 seconds)														
Dielectric strength	2500 VAC (50/60 Hz) for 1 minute (between the current input, voltage input, and earth)														
Insulation resistance	100 MΩ (500 VDC between the current input, voltage input, and earth)														
Computation functions	The same as the computation function (/M1)														
Effects of the operating conditions	<p>Ambient temperature ±0.05%/°C (under the following conditions: 0 to 50°C, 0.05 In ≤ I ≤ I_{max}, power factor = 1) ±0.07%/°C (under the following conditions: 0 to 50°C, 0.1 In ≤ I ≤ I_{max}, power factor = 0.5) In: Rated current</p> <p>Voltage variation Within the degree of accuracy (90 to 132 VAC or 180 to 250 VAC; frequency is 50 or 60 Hz)</p> <p>External magnetic fields 400 A/m or less Active power and voltage: ±1.0% of range</p> <p>Effect of the input frequency For a change within 45 to 65 Hz, the effect on the active power, voltage, and current is within the accuracies.</p>														

13.6 General Specifications

Construction

Item	Specifications
Mounting	Flush panel mounting (on a vertical plane)
Mounting angle	Inclined backward up to 30 degrees from a horizontal plane.
Allowable panel thickness	2 to 26 mm
Material	Case: Metal plate Bezel and display cover: Polycarbonate
Color	Case: Grayish blue green (Munsell 2.0B5.0/1.7 or equivalent) Bezel: Charcoal gray light (Munsell 10B3.6/0.3 or equivalent)
Front panel	Water and dust proof: Complies with IEC529-IP65, except side-by-side mounting
External dimensions	144 (W) × 144 (H) × 161.7 (D) mm (D: depth from the panel mounting plane)
Weight	FX1002, FX1004, FX1006: 1.3 kg FX1008, FX1010, FX1012: 1.4 kg (Not including options)

Normal Operating Conditions

Item	Specifications
Supply voltage	90 to 132, 180 to 250 VAC
Power supply frequency	50 Hz ± 2%, 60 Hz ± 2%
Ambient temperature	0 to 50°C
Ambient humidity	20 to 80%RH (However, less than moisture content of 40°C 80%RH at 40°C or more), No condensation.
or more), (no condensation)	
Vibration	10 to 60 Hz, 0.2 m/s ²
Shock	Not allowed
Magnetic field	400 A/m or less (DC and 50/60 Hz)
Noise	Normal mode (50/60 Hz)
DC voltage	The peak value including the signal must be less than 1.2 times the measuring range.
Thermocouple	The peak value including the signal must be less than 1.2 times the measuring thermal electromotive force.
RTD	50 mV or less
Common mode voltage	30 VACrms, ±60 VDC, or less for all ranges (Maximum common mode noise voltage: 250 VACrms (50 or 60 Hz))
Maximum noise voltage between channels	FX1xxx-x-x-H: 250 VACrms (50 or 60 Hz) or less FX1xxx-x-x-L: 60 VACrms (50 or 60 Hz) or less
Mounting position	Can be inclined up to 30 degrees backward. Left and right horizontal.
Warm-up time	At least 30 minutes after power on
Installation location	Indoors
Operating altitude	2000 m or less

Power Supply

Item	Specifications												
Rated supply voltage	100 to 240 VAC												
Allowable power supply voltage range	90 to 264 VAC												
Rated power supply frequency	50 Hz, 60 Hz												
Power consumption	<table border="1"> <thead> <tr> <th>Supply voltage</th> <th>LCD backlight off</th> <th>Normal</th> <th>Maximum</th> </tr> </thead> <tbody> <tr> <td>100 VAC</td> <td>10 VA</td> <td>13 VA</td> <td>35 VA</td> </tr> <tr> <td>240 VAC</td> <td>14 VA</td> <td>18 VA</td> <td>45 VA</td> </tr> </tbody> </table>	Supply voltage	LCD backlight off	Normal	Maximum	100 VAC	10 VA	13 VA	35 VA	240 VAC	14 VA	18 VA	45 VA
	Supply voltage	LCD backlight off	Normal	Maximum									
	100 VAC	10 VA	13 VA	35 VA									
240 VAC	14 VA	18 VA	45 VA										
Allowable interruption time	Less than 1 cycle of the power supply frequency												

13.6 General Specifications

Isolation

Item	Specifications
Insulation resistance	Between the Ethernet, RS-422A/485, and insulation terminals and earth: 20 M Ω or greater at 500 VDC
Withstand voltage	Between the power terminal and earth: 2300 VAC at 50/60 Hz for one minute
	Between the contact output terminal and earth: 1600 VAC at 50/60 Hz for one minute
	Between the measurement input terminal and earth: 1500 VAC at 50/60 Hz for one minute
	Between the measurement input terminals (excluding the RTD input terminal of the FX1006, FX1008, FX1010, FX1012):
	FX1xxx-x-x-H: 1000 VAC (50 or 60 Hz) for 1 minute
	FX1xxx-x-x-L: 400 VAC (50 or 60 Hz) for 1 minute
	Between the remote input terminal and earth: 1000 VDC for one minute
Between the pulse input terminal and earth: 1000 VDC for one minute	
Between the power monitor input terminals (current input, voltage input, and earth): 2500 VAC (50 or 60 Hz) for 1 minute	
Ground	Grounding resistance: 100 Ω or less

Transport and Storage Conditions

Item	Specifications
Ambient temperature	-25 to 60°C
Ambient humidity	5 to 95%RH (no condensation)
Vibration	10 to 60 Hz, 4.9 m/s ² maximum
Shock	392 m/s ² maximum (in packaged condition)

Supported Standards

Item	Specifications
CSA	CAN/CSA-C22.2 No.61010-1, CAN/CSA-C22.2 No.61010-2-030, Overvoltage Category II or I ¹ , Pollution Degree 2 ² , Measurement Category II ³
UL	UL61010-1, UL61010-2-030 (CSA NRTL/C), Overvoltage Category II or I ¹ , Pollution Degree 2 ² , Measurement Category II ³
CE	
EMC directive	EN61326-1 Class A, Table 2 (For use in industrial locations) compliant EN61000-3-2 compliant EN61000-3-3 compliant EN55011 Class A, Group 1 compliant
Low voltage directive	EN61010-1, EN 61010-2-030 compliance, Overvoltage Category II or I ¹ , Pollution Degree 2 ² , Measurement Category II ³
RoHS directive	"2011/65/EU+(EU)2015/863" (10-Substances) compliant
WEEE directive	Compliant
EMC regulatory arrangement in Australia and New Zealand (RCM)	EN55011 Class A, Group 1 compliant
KC marking	KN11, KN61000-6-2 compliant

1 Overvoltage Category: Describes a number which defines a transient overvoltage condition. Implies the regulation for impulse withstand voltage. "II" applies to electrical equipment which is supplied from the fixed installation like a distribution board.

II: Applied to standard power supply (100-240 VAC)

I: Applied to /P1 option (24 VDC/AC)

2 Pollution Degree 2: Describes the degree to which a solid, liquid, or gas which deteriorates dielectric strength or surface resistivity is adhering. "2" applies to normal indoor atmosphere. Normally, only non-conductive pollution occurs.

3 Measurement Category II: Applies to measuring circuits connected to low voltage installation, and electrical instruments supplied with power from fixed equipment such as electric switchboards.

Standard Performance

Item	Specifications		
Measurement/display accuracy	Standard operating conditions: Temperature: 23 ± 2°C Humidity: 55 ± 10%RH Power supply voltage: 90 to 132 or 180 to 250 VAC Power supply frequency: 50/60 Hz ± 1% Warm-up time: At least 30 minutes. Other ambient conditions such as vibration should not adversely affect the operation.		
Input Type	Range	Measurement Accuracy (Digital display)	Digital Display Max. Resolution
DC voltage	20 mV	±(0.05% of rdg + 12 digits)	1 μV
	60 mV	±(0.05% of rdg + 3 digits)	10 μV
	200 mV		10 μV
	1 V	±(0.05% of rdg + 12 digits)	100 μV
	2 V		100 μV
	1 to 5 V	±(0.05% of rdg + 3 digits)	1 mV
	6 V		1 mV
	20 V		1 mV
50 V	10 mV		
Thermocouple (Not including the accuracy of reference junction compensation; when the burnout detection function is off.)	R	±(0.15% of rdg + 1°C) R, S 0 to 100°C: ±3.7°C, 100 to 300°C: ±1.5°C B 400 to 600°C: ±2°C; accuracy not guaranteed for temperatures less than 400°C	0.1°C
	S		
	B		
	K	±(0.15% of rdg + 0.7°C) –200 to –100°C: ±(0.15% of rdg + 1°C)	
	E	±(0.15% of rdg + 0.5°C) –200 to –100°C: ±(0.15% of rdg + 0.7°C)	
	J		
	T		
	N	±(0.15% of rdg + 0.7°C) –200 to 0°C: ±(0.35% of rdg + 0.7°C) Accuracy not guaranteed for temperatures less than –200°C.	
	W	±(0.15% of rdg + 1°C)	
	L	±(0.15% of rdg + 0.5°C)	
	U	–200 to –100°C: ±(0.15% of rdg + 0.7°C)	
WRe	±(0.2% of rdg + 2.5°C) 0 to 200°C: ±4.0°C		
RTD	Pt100	±(0.15% of rdg + 0.3°C)	
	JPt100		
DI	Voltage	Threshold level (Vth=2.4 V) accuracy ± 0.1 V	
	Contact	With parallel capacitance of 0.01 μF or less, 1 kΩ or less: 1 (ON). 100 kΩ or more: 0 (OFF)	

Measuring accuracy in case of scaling

Accuracy during scaling (digits) = measurement accuracy (digits) × multiplier + 2 digits (rounded up)

* Fractions rounded up

where the multiplier = scaling span (digits)/measuring span (digits).

Example For 1-5 V range (A/D integration time is 16.7 ms or more), measurement span of 1.000 to 5.000 V, and scaling span of 0.000 to 2.000

The measuring accuracy for 5 V input is as follows.

Measuring accuracy (1-5 V range) = ±(0.05% × 5 V + 3 digits) = ±(0.0025 V [3 digits] + 3 digits) = ±6 digits

Multiplier = {2000 digits (0.000 to 2.000)}/4000 digits (1.000 to 5.000) = 0.5

Thus, accuracy during scaling = ±(6 × 0.5 + 2) digits = 5 digits (rounded up)

Reference junction compensation accuracy

When measuring temperature greater than or equal to 0 °C and when input terminal temperature is balanced

Type R, S, W, WRe: ±1.0°C

Type K, J, E, T, N, L, and U: ±0.5°C

Type B: Internal reference compensation is fixed to 0°C

13.6 General Specifications

Item	Specifications
Maximum input voltage	±60 VDC (continuous)
Input resistance	1 V range or less and TC: 10 MΩ or more 2 V range or higher: Approx. 1 MΩ
Input source resistance	
Volt, TC	2 kΩ or less
RTD input	10 Ω or less per wire (The resistance of all three wires must be equal).
Bias current	10 nA or less (except when burnout detection function is enabled)
Maximum common mode noise voltage	250 VACrms (50 Hz/60 Hz)
Maximum noise voltage between channels	FX1xxx-x-x-H 250VACrms (50/60Hz) FX1xxx-x-x-L 60VACrms (50/60Hz)
Interference across channels	120 dB (when the input source resistance is 500 Ω and the input to other channels is 60 VDC)
Common mode rejection ratio	
When the A/D integration time is 20 ms	120 dB (50 Hz ± 0.1%, 500 Ω unbalanced, between the minus terminal and ground)
When the A/D integration time is 16.7 ms	120 dB (60 Hz ± 0.1%, 500 Ω unbalanced, between the minus terminal and ground)
Normal mode rejection ratio	
When the A/D integration time is 20 ms	40 dB or more (50 Hz ± 0.1%)
When the A/D integration time is 16.7 ms	40 dB or more (60 Hz ± 0.1%)

Effects of Operating Conditions

Item	Specifications
Ambient temperature (with temperature variation of 10°C)	
DC voltage, TC range	±(0.1% of rdg + 0.05% of range) or less * Excluding the error of reference junction compensation
RTD range	±(0.1% of rdg + 2 digits) or less
Power supply fluctuation	With variation within 90 to 132 V and 180 to 250 VAC (50/60 Hz): Accuracy specifications are satisfied. With variation of ±2 Hz from rated power frequency (power supply voltage 100 VAC): Accuracy specifications are satisfied.
Magnetic field	AC (50/60 Hz) and DC 400 A/m fields: ±(0.1% of rdg + 10 digits) or less
Input source resistance	
DC voltage range	With variation of +1 kΩ: 1 V range or less: ±10 μV or less 2 V range or higher: ±0.15% of rdg or less
TC range	With variation of +1 kΩ: ±10 μV or less
RTD range (Pt100)	With variation of 10 Ω per wire (resistance of all three wires must be equal): ±(0.1% of rdg + 1 digits) or less With maximum difference of 40 mΩ between wires: Approx. 0.1 °C
Effects of vibration	Effects from a sinusoidal vibration along all three axis at a frequency between 10 to 60 Hz and an acceleration of 0.2 m/s ² : ±(0.1% of rdg + 1 digit) or less

Miscellaneous

Item	Specifications
Memory backup	A built-in lithium battery backs up the settings and runs the clock Battery life: Approximately 10 years (at room temperature)

13.7 External Dimensions

See section 12.3.

14.1 Setting Mode Menu Map and Setup Items

Run Modes

Mode Transition Diagram

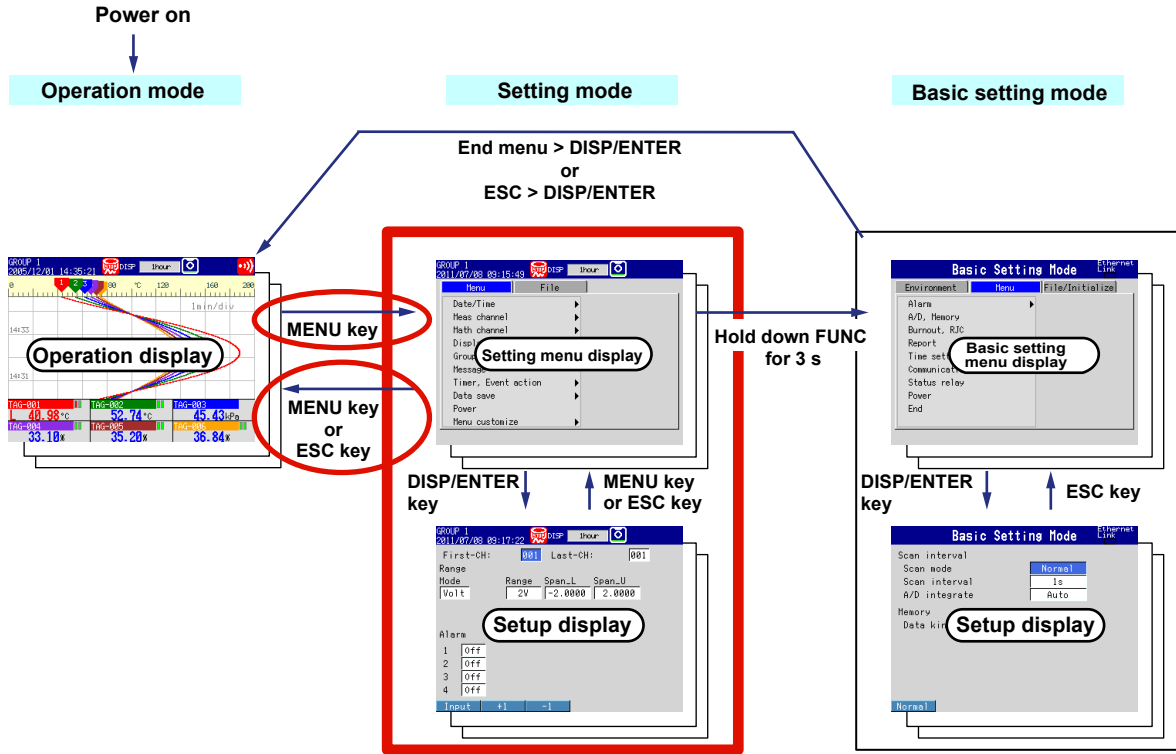

The FX has three modes.

Mode	Description
Operation mode	A mode for performing measurements.
Setting mode	A mode for configuring settings, such as the input range and the measurement method. Most settings can be changed when memory sampling is in progress.
Basic setting mode	A mode for configuring basic settings, such as the scan interval and the measured data save method. You cannot switch to this mode when memory sampling is in progress.

Setting Mode Menu

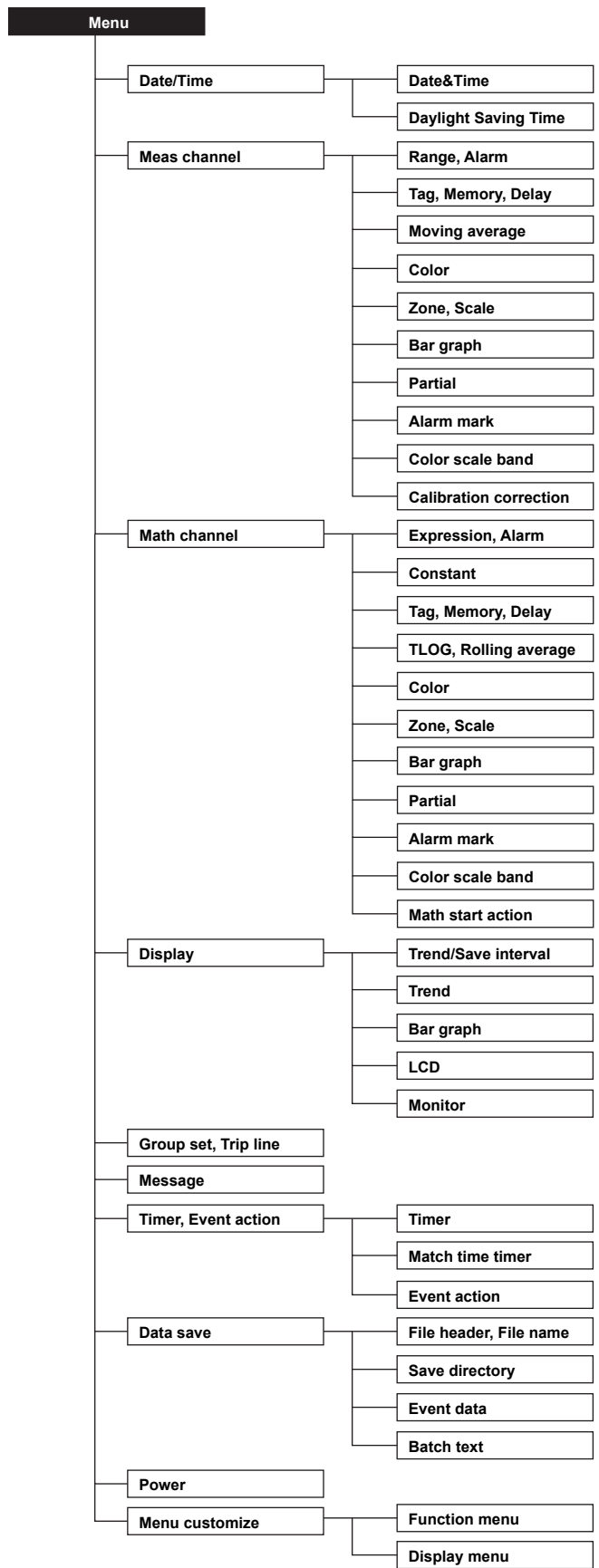

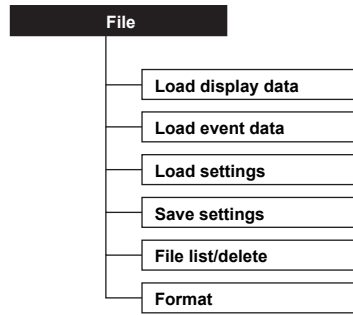

14.1 Setting Mode Menu Map and Setup Items

Setup Items in Setting Mode

Menu tab

Date/Time > Date&Time

Setup Item	Selectable Range or Selections	Default Value	Setting
Date&Time > Time set	-	2011/01/01 00:00:00	

Date/Time > Daylight Saving Time

Setup Item	Selectable Range or Selections	Default Value	Setting
Use/Not	Use/Not	Not	
Start time > Month	JAN/FEB/MAR/APR/MAY/JUN/JUL/AUG/SEP/OCT/NOV/DEC	MAR	
Start time > Day order	1st/2nd/3rd/4th/Last	2nd	
Start time > Day of the week	SUN/MON/TUE/WED/THU/FRI/SAT	SUN	
Start time > Hour of the day	Numerical value (0 to 23)	2	
End time > Month	JAN/FEB/MAR/APR/MAY/JUN/JUL/AUG/SEP/OCT/NOV/DEC	NOV	
End time > Day order	1st/2nd/3rd/4th/Last	1st	
End time > Day of the week	SUN/MON/TUE/WED/THU/FRI/SAT	SUN	
End time > Hour of the day	Numerical value (0 to 23)	1	

Meas channel > Range, Alarm

Setup Item	Selectable Range or Selections	Default Value	Setting
First-CH, Last-CH	Channel number	001	
Range > Mode	Skip/Volt/TC/RTD/Scale/Delta/DI/ 1-5V/LogType1/LogType2/Sqrt	Volt	
Mode = Volt			
Range	20mV/60mV/200mV/2V/6V/20V/50V/1V	2V	
Span Lower	Numerical value (depends on the range)	-	
Span Upper	Numerical value (depends on the range)	-	
Mode = TC			
Range	R/S/B/K/E/J/T/N/W/L/U/WRe (Options may add additional settings.)	R	
Span Lower	Numerical value (depends on the range)	-	
Span Upper	Numerical value (depends on the range)	-	
Mode = RTD			
Range	Pt/JPt (Options may add additional settings.)	Pt	
Span Lower	Numerical value (depends on the range)	-	
Span Upper	Numerical value (depends on the range)	-	
Mode = Scale			
Type	Volt/TC/RTD/DI	Volt	
Range	Depends on the type	-	
Span Lower	Numerical value (depends on the range)	-	
Span Upper	Numerical value (depends on the range)	-	
Scale Lower	Numerical value (-30000 to 30000; decimal place: 0 to 4)	0.00	
Scale Upper	Numerical value (-30000 to 30000)	200.00	
Unit	6 characters or less		
Mode = Delta			
Type	Volt/TC/RTD/DI	Volt	
Range	Depends on the type	-	
Span Lower	Numerical value (depends on the range)	-	
Span Upper	Numerical value (depends on the range)	-	
Ref.CH	Meas channel number	-	

14.1 Setting Mode Menu Map and Setup Items

Setup Item	Selectable Range or Selections	Default Value	Setting
Mode = DI			
Range	Level/Cont	Level	
Span Lower	Numerical value (0 or 1)	0	
Span Upper	Numerical value (0 or 1)	1	
Mode = 1-5V			
Range	1-5V	1-5V	
Span Lower	Numerical value (0.800 to 5.200)	1.000	
Span Upper	Numerical value (0.800 to 5.200)	5.000	
Scale Lower	Numerical value (–30000 to 30000; decimal place: 0 to 4)	0.00	
Scale Upper	Numerical value (–30000 to 30000)	200.00	
Unit	6 characters or less	–	
Low-cut	On/Off	Off	
Mode = Sqrt			
Range	20mV/60mV/200mV/2V/6V/20V/50V/1V		
Span Lower	Numerical value (depends on the range)	–	
Span Upper	Numerical value (depends on the range)	–	
Scale Lower	Numerical value (–30000 to 30000; decimal place: 0 to 4)	0.00	
Scale Upper	Numerical value (–30000 to 30000)	200.00	
Unit	6 characters or less	–	
Low-cut	On/Off	Off	
Low-cut value	Numerical value (0.0 to 5.0)	0.5	
Mode = LogType1			
Range	20mV/60mV/200mV/2V/6V/20V/50V/1V	2V	
Span Lower	Numerical value (depends on the range)	–2.0000	
Span Upper	Numerical value (depends on the range)	2.0000	
Scale Lower	Mantissa (1.00 to 9.99) and exponent (–15 to 15)	2.00E0	
Scale Upper	Mantissa (1.00 to 9.99) and exponent (–15 to 15)	2.00E14	
Unit	6 characters or less	–	
Mode = LogType2			
Range	20mV/60mV/200mV/2V/6V/20V/50V/1V	2V	
Span Lower	Numerical value (depends on the range)	–2.0000	
Span Upper	Numerical value (depends on the range)	2.0000	
Scale Lower	Mantissa (1.00 to 9.99) and exponent (–15 to 15)	2.00E0	
Scale Upper	Mantissa (automatically set to the same value as Scale Lower) and exponent (–15 to 15)	–	
Unit	6 characters or less	–	
Alarm			
1, 2, 3, 4	On/Off	Off	
Type	H: High/L: Low/h: delta H/l: delta L/ R: rate H/r: rate L/T: delay H/t: delay L	H	
Value	Numerical value When Mode is LogType, this is set with the mantissa and the exponent. The range is 1.00E–16 to 1.00E+16 (the mantissa range is 1.00 to 9.99)	–	
Relay	On/Off	Off	
Number	I01/I02/. . . /I06, I11/I12/. . . /I16 (depends on the options) S01/S02/S03/. . . /S29/S30	I01	
Detect	On/Off	On	

Meas channel > Tag, Memory, Delay

Setup Item	Selectable Range or Selections	Default Value	Setting
First-CH, Last-CH	Channel number	001	
Tag > Characters	16 characters or less	–	
Memory sample > On/Off	On/Off	On	
Alarm delay > Time	Numerical value (1 to 3600; in seconds)	10	

Meas channel > Moving average

Setup Item	Selectable Range or Selections	Default Value	Setting
First-CH, Last-CH	Channel number	001	
On/Off	On/Off	Off	
Count	Numerical value (2 to 400)	2	

14.1 Setting Mode Menu Map and Setup Items

Meas channel > Color

Setup Item	Selectable Range or Selections	Default Value	Setting
Group of channel	Channel number	001 to 006	
Color	Red/Green/Blue/B.violet/Brown/Orange/Y.green/Lightblue/Violet/ Gray/Lime/Cyan/Darkblue/Yellow/Lightgray/ Purple/Black/Pink/L.brown/L.green/Darkgray/Olive/ DarkCyan/S.green (24 colors)	Red to orange	

Meas channel > Zone, Scale

Setup Item	Selectable Range or Selections	Default Value	Setting
First-CH, Last-CH	Channel number	001	
Zone > Lower	Numerical value (0 to 95)	0	
Zone > Upper	Numerical value (5 to 100)	100	
Scale > Position	Off/1/2/3/4/5/6	1	
Scale > Division	4/5/6/7/8/9/10/11/12/C10	10	

Meas channel > Bar graph

Setup Item	Selectable Range or Selections	Default Value	Setting
First-CH, Last-CH	Channel number	001	
Base position	Normal/Center/Lower/Upper	Normal	
Division	4/5/6/7/8/9/10/11/12	10	

Meas channel > Partial

Setup Item	Selectable Range or Selections	Default Value	Setting
First-CH, Last-CH	Channel number	001	
On/Off	On/Off	Off	
Expand	Numerical value (1 to 99%)	50	
Boundary	Numerical value (span lower + 1 digit to span upper – 1 digit)	0.0000	

Meas channel > Alarm mark

Setup Item	Selectable Range or Selections	Default Value	Setting
First-CH, Last-CH	Channel number	001	
Mark kind	Alarm/Fixed	Alarm	
Indicate on Scale	On/Off	Off	
Alarm mark color > Alarm 1	Red/Green/. . . /S.green (24 colors)	Red	
Alarm mark color > Alarm 2	The same as Alarm 1	Orange	
Alarm mark color > Alarm 3	The same as Alarm 1	Orange	
Alarm mark color > Alarm 4	The same as Alarm 1	Red	

Meas channel > Color scale band

Setup Item	Selectable Range or Selections	Default Value	Setting
First-CH, Last-CH	Channel number	001	
Band area	Off/In/Out	Off	
Color	Red/Green/. . . /S.green (24 colors)	Lime	
Display position > Lower	Numerical value (measuring range) When Mode is LogType, this is set with the mantissa and the exponent. The range is 1.00E–16 to 1.00E+16 (the mantissa range is 1.00 to 9.99)	0.0000	
Display position > Upper	The same as Lower	0.0100	

Meas channel > Calibration correction

Setup Item	Selectable Range or Selections	Default Value	Setting
First-CH, Last-CH	Channel number	001	
Number of set points	Off/2/3/4/5/6/7/8/9/10/11/12/13/14/15/16	Off	
1 to n > MES val	Input (value in the measuring range)/measured value	-	
1 to n > True val	Numerical value (measuring range)	-	

Math channel > Expression, Alarm

Setup Item	Selectable Range or Selections	Default Value	Setting
First-CH, Last-CH	Channel number	101	
Math On/Off	On/Off	Off	
Calculation expression	120 characters or less	-	
Span Lower	Numerical value (-9999999 to 99999999; decimal place: 0 to 4)	-200.00	
Span Upper	Numerical value (-9999999 to 99999999; decimal place: 0 to 4)	200.00	
Unit	6 characters or less	-	
Math alarm			
1, 2, 3, 4	On/Off	Off	
Type	H: High/L: Low/T: delay H/t: delay L	-	
Value	Numerical value	-	
Relay	On/Off	Off	
No.	I01/I02/. . . /I06, I11/I12/. . . /I16 (depends on the options) I01 S01/S02/S03/. . . /S29/S30		
Detect	On/Off	On	

Math channel > Constant

Setup Item	Selectable Range or Selections	Default Value	Setting
Number of constant	Numerical value (K01 to K60)	K01	
Value	Numerical value (-9.9999E+29 to -1.0000E-30, 0, 1.0000E-30 to 9.9999E+29)	1	

Math channel > Tag, Memory, Delay

Except for the channel numbers, setup items and values are the same as those for measurement channels.

Math channel > TLOG, Rolling average

Setup Item	Selectable Range or Selections	Default Value	Setting
First-CH, Last-CH	Channel number	101	
TLOG > Timer No.	1/2/3/4	1	
TLOG > Sum scale	Off, /s, /min, /h	Off	
TLOG > Reset	On/Off	Off	
Rolling average > On/Off	On/Off	Off	
Rolling average > Interval	1s/2s/3s/4s/5s/6s/10s/12s/15s/20s/30s/ 1min/2min/3min/4min/5min/6min/10min/12min/ 15min/20min/30min/1h	10s	
Rolling average > Number of samples	Numerical value (1 to 1500)	1	

14.1 Setting Mode Menu Map and Setup Items

Math channel > Color

Except for the channel numbers, setup items and values are the same as those for measurement channels.

Math channel > Zone, Scale

Except for the channel numbers, setup items and values are the same as those for measurement channels.

Math channel > Bar graph

Except for the channel numbers, setup items and values are the same as those for measurement channels.

Math channel > Partial

Except for the channel numbers, setup items and values are the same as those for measurement channels.

Math channel > Alarm mark

Except for the channel numbers, setup items and values are the same as those for measurement channels.

Math channel > Color scale band

Except for the channel numbers, setup items and values are the same as those for measurement channels.

Math channel > Math start action

Setup Item	Selectable Range or Selections	Default Value	Setting
Math start	Off/Start/Rst+St	Start	

Display > Trend/Save interval

Setup Item	Selectable Range or Selections	Default Value	Setting
Trend interval (/div)	15s/30s/1min/2min/5min/10min/15min/20min/ 30min/1h/2h/4h/10h (depends on the model)	1min	
Save interval	10min to 31day (depends on the trend interval)	1h	
Second interval (/div)	15s/30s/1min/2min/5min/10min/15min/20min/ 30min/1h/2h/4h/10h (depends on the model)	1min	

Display > Trend

Setup Item	Selectable Range or Selections	Default Value	Setting
Direction	Horizontal/Vertical/Wide	Vertical	
Trend clear	On/Off	Off	
Message direction	Horizontal/Vertical	Horizontal	
Scale > Digit	Normal/Fine	Normal	
Scale > Value indicator	Mark/Bargraph	Mark	
Trend line	1/2/3	2	
grid	Auto/4/5/6/7/8/9/10/11/12	Auto	

Display > Bar graph

Setup Item	Selectable Range or Selections	Default Value	Setting
Direction	Horizontal/Vertical	Vertical	

Display > LCD

Setup Item	Selectable Range or Selections	Default Value	Setting
Brightness	1/2/3/4/5/6/7/8	2	
Backlight saver > Mode	Off/Dimmer/Timeoff	Off	
Backlight saver > Saver time	1min/2min/5min/10min/30min/1h	1h	
Backlight saver > Restore	Key, Key+Alarm	Key+Alarm	

Display > Monitor

Setup Item	Selectable Range or Selections	Default Value	Setting
Background > Display	White/Black	White	
Background > Historical trend	White/Cream/Black/Lightgray	Black	
Scroll time	5s/10s/20s/30s/1min	10s	
Jump default display	Off/1min/2min/5min/10min/20min/30min/1h	Off	

Group set, Trip line

Setup Item	Selectable Range or Selections	Default Value	Setting
Group number	Numerical value (1 to 10)	1	
Group set > On/Off	On/Off	Groups 1 to 4: On Groups 5 to 10: Off	
Group set > Group name	16 characters or less	For example, "GROUP1"	
Group set > CH set	39 characters or less	Depends on the model	
Trip line > 1	On/Off	Off	
Trip line > 2	On/Off	Off	
Trip line > 3	On/Off	Off	
Trip line > 4	On/Off	Off	
Trip line > Position	Numerical value (0 to 100)	50	
Trip line > Color	Red/Green/. . . /S.green (24 colors)	1: Red. 2: Green. 3: Blue. 4: Yellow.	
Trip line > Width	1/2/3	2	

Message

Setup Item	Selectable Range or Selections	Default Value	Setting
Message No.	1-10/11-20/21-30/31-40/41-50/51-60/ 61-70/71-80/81-90/91-100	11-20	
1 to 100	32 characters or less	-	

Timer, Event action > Timer

Setup Item	Selectable Range or Selections	Default Value	Setting
Timer No.	Numerical value (1 to 4)	1	
Mode	Off/Relative/Absolute	Off	
Relative > Interval	Numerical value (00:01 to 24:00)	01:00	
Relative > Reset at Math Start	On/Off	On	
Absolute > Interval	1min/2min/3min/4min/5min/6min/10min/ 12min/15min/20min/30min/1h/2h/3h/4h/ 6h/8h/12h/24h	1h	
Absolute > Ref.time	Numerical value (0 to 23)	0:00	

Timer, Event action > Match time timer

Setup Item	Selectable Range or Selections	Default Value	Setting
Timer number	Numerical value (1 to 4)	1	
Kind	Off/Day/Week/Month	Off	
Day	Numerical value (1 to 28)	1	
Day of the week	SUN/MON/TUE/WED/THU/FRI/SAT	SUN	
Hour:Minute	Numerical value (00:00 to 23:59)	00:00	
Timer action	Single/Repeat	Repeat	

14.1 Setting Mode Menu Map and Setup Items

Timer, Event action > Event action

Setup Item	Selectable Range or Selections	Default Value	Setting
Logic box number	Numerical value (1 to 40)	1	
Event	None/Remote/Relay/Switch/Timer/Match time timer/Alarm/UserKey	None	
Remote > Remote number	1/2/3/4/5/6/7/8	1	
Relay > Relay number	I01/I02/.../I06, I11/I12/.../I16 (depends on the options)	I01	
Switch > Switch No.	S01/S02/S03/.../S29/S30	S01	
Timer > Timer No.	1/2/3/4	1	
Match time timer > Timer number	1/2/3/4	1	
Action	MemoryStart/Stop, MemoryStart, MemoryStop, Trigger, AlarmACK, MathStart/Stop, MathStart, MathStop, MathReset, SaveDisplay, SaveEvent, Message, Snapshot, DisplayRate1/2, ManualSample, TimerReset, DisplayGroupChange, Flag, PanelLoad, TimeAdjust (depends on settings such as the event settings)	DisplayGroup Change	
Message > Message No.	Numerical value (1 to 100)	1	
Message > Write to	All/Select	All	
Message > Group number	1/2/3/4/5/6/7/8/9/10	1	
Group > Group number	1/2/3/4/5/6/7/8/9/10	1	
Flag > Flag number	1/2/3/4/5/6/7/8	1	
TimerReset > Timer No.	1/2/3/4	1	
PanelLoad > Setting file number	1/2/3	1	

Data save > File header, File name

Setup Item	Selectable Range or Selections	Default Value	Setting
File header > Characters	50 characters or less	-	
Data file name > Structure	Date/Serial/Batch	Date	
Data file name > Identified strings	16 characters or less	-	

Data save > Save directory

Setup Item	Selectable Range or Selections	Default Value	Setting
Directory name	20 characters or less	DATA0	

Data save > Event data

Setup Item	Selectable Range or Selections	Default Value	Setting
Sample rate	125ms/250ms/500ms/1s/2s/5s/10s/ 30s/1min/2min/5min/10min (depends on the model)	1s	
Mode	Free/Single/Repeat	Free	
Data length	10min to 31day (depends on the sample rate)	1h	
Pre-trigger	0/5/25/50/75/95/100	0	
Trigger signal > Key	On/Off	On	

Data save > Batch text

Setup Item	Selectable Range or Selections	Default Value	Setting
Text field number	Numerical value (1 to 8)	1	
Text field > Title of field	20 characters or less	-	
Text field > Characters	30 characters or less	-	

Power

Setup Item	Selectable Range or Selections	Default Value	Setting
VT ratio	Numerical value (1.0 to 6000.0)	1.0	
CT ratio	Numerical value (0.05 to 32000)	1.00	
Low-cut power	Numerical value (0.05 to 20.00)	0.05%	

Menu customize

Setup Item	Selectable Range or Selections	Default Value	Setting
Function menu	Select/Hide/View/Transfer	–	
Display menu	Separate/Select/Hide/View/Transfer	–	

File tab**Load display data**

Setup Item	Selectable Range or Selections	Default Value	Setting
Kind	CF/SD/USB	CF/SD	

Load event data

Setup Item	Selectable Range or Selections	Default Value	Setting
Kind	CF/SD/USB	CF/SD	

Load settings

Setup Item	Selectable Range or Selections	Default Value	Setting
Kind	CF/SD/USB	CF/SD	

Save settings

Setup Item	Selectable Range or Selections	Default Value	Setting
Kind	CF/SD/USB	CF/SD	
File name	32 characters or less	–	

File list/delete

Setup Item	Selectable Range or Selections	Default Value	Setting
Kind	CF/SD/USB	CF/SD	

Format

Setup Item	Selectable Range or Selections	Default Value	Setting
Kind	CF/USB	CF	
Format > Volume name	11 characters or less	–	

14.2 Basic Setting Mode Menu Map and Setup Items

Run Modes

Mode Transition Diagram

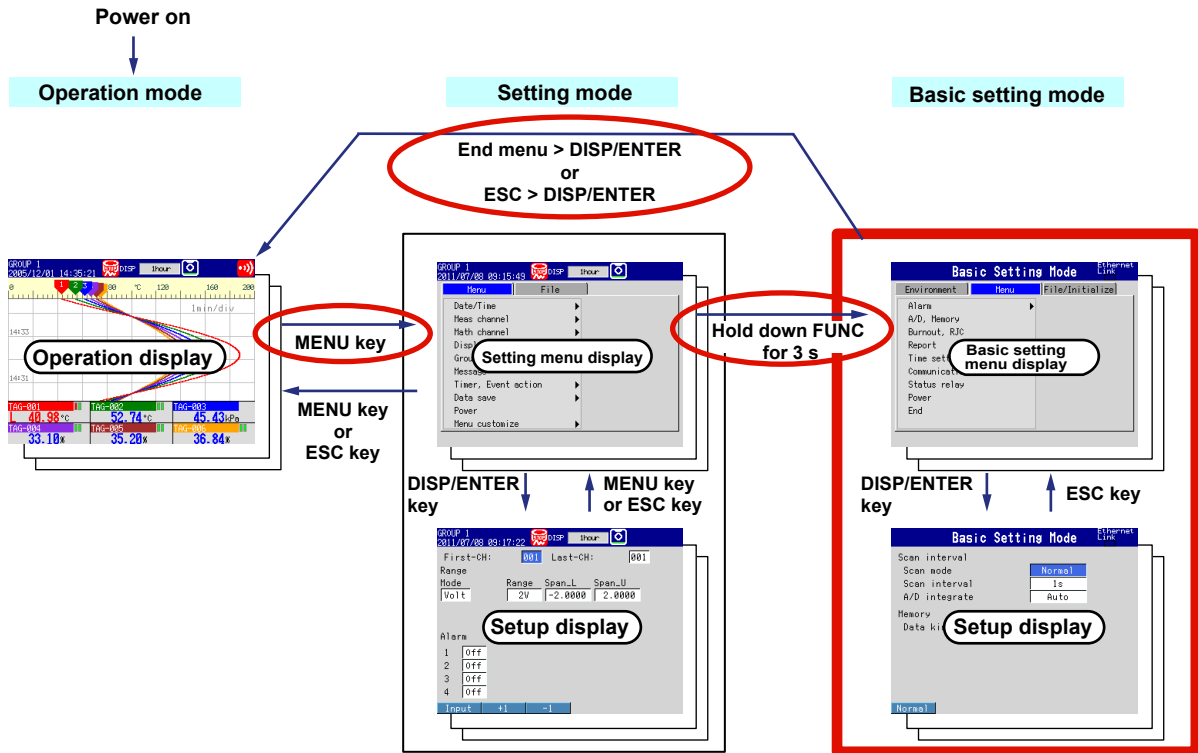

The FX has three modes.

Mode	Description
Operation mode	A mode for performing measurements.
Setting mode	A mode for configuring settings, such as the input range and the measurement method. Most settings can be changed when memory sampling is in progress.
Basic setting mode	A mode for configuring basic settings, such as the scan interval and the measured data save method. You cannot switch to this mode when memory sampling is in progress.

Basic Setting Mode Menu

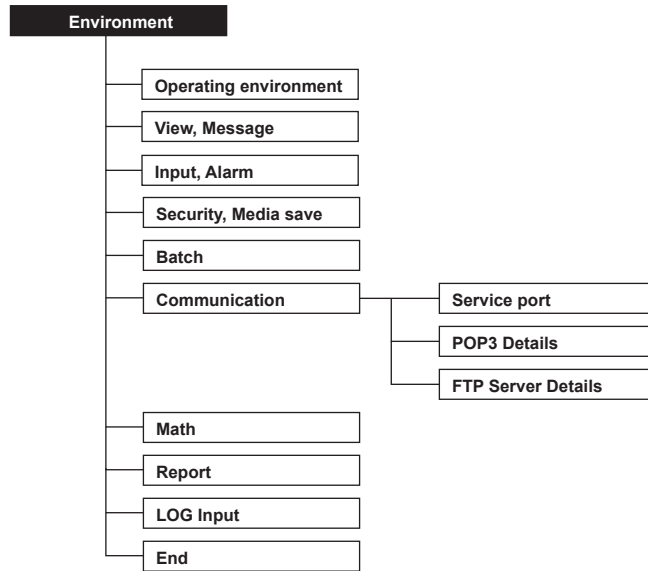

14.2 Basic Setting Mode Menu Map and Setup Items

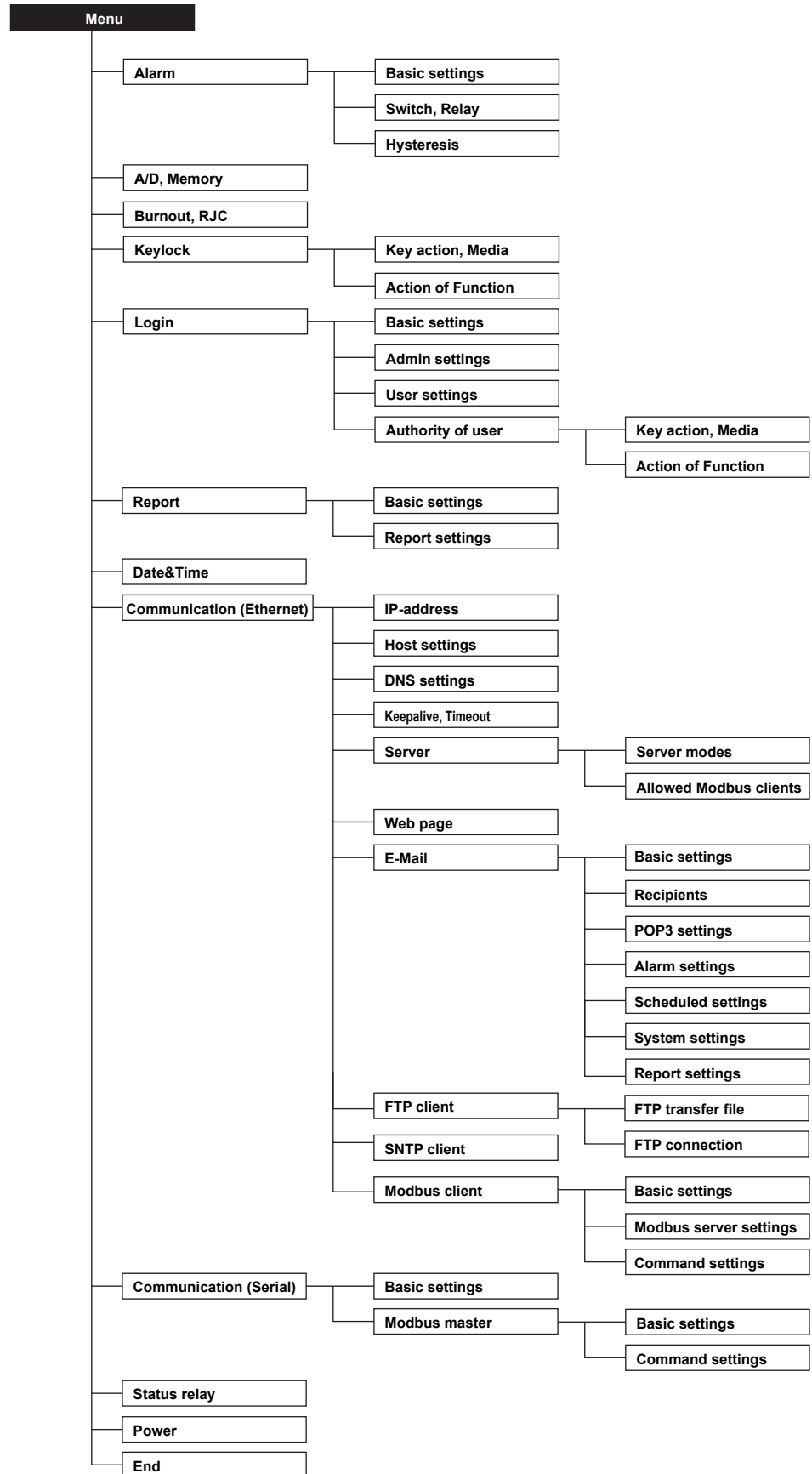

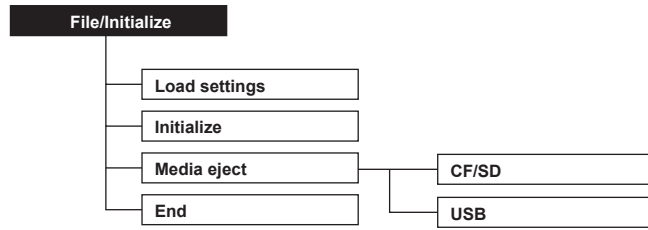

Setup Items in Basic Setting Mode

Environment tab

Operating environment

Setup Item	Selectable Range or Selections	Default Value	Setting
Tag/Channel	Tag/Channel	Tag	
Language	English/Japanese/German/French/Chinese/Italian/ Spanish/Portuguese/Russian/Korean	English	
Temperature	C/F	C	
Decimal Point Type	Point/Comma	Point	

View, Message

Setup Item	Selectable Range or Selections	Default Value	Setting
View > Trend type	T-Y	T-Y	
View > Partial	On/Off	Off	
View > Trend rate switching	On/Off	Off	
Message > Write group	Common/Separate	Common	
Message > Power-fail message	On/Off	Off	
Message > Change message	On/Off	Off	

Input, Alarm

Setup Item	Selectable Range or Selections	Default Value	Setting
Input > Value on over-range	Free/Over	Over	
Alarm > No logging	On/Off	Off	

Security, Media save

Setup Item	Selectable Range or Selections	Default Value	Setting
Security > Key	Off/Login/Keylock	Off	
Security > Communication	Off/Login	Off	
Save > Auto save	On/Off	On	
Save > Media FIFO	On/Off	Off	

Batch

Setup Item	Selectable Range or Selections	Default Value	Setting
On/Off	On/Off	Off	
Lot-No. digit	Off/4/6/8	6	
Auto increment	On/Off	On	

Communication > Service port

Setup Item	Selectable Range or Selections	Default Value	Setting
FTP	Numerical value (1 to 65535)	21	
HTTP	Numerical value (1 to 65535)	80	
SNTP	Numerical value (1 to 65535)	123	
Modbus	Numerical value (1 to 65535)	502	

Communication > POP3 Details

Setup Item	Selectable Range or Selections	Default Value	Setting
POP3 Before SMTP > Send delay [second]	0 to 10	2	
POP3 Login	PLAIN/APOP	PLAIN	

Communication > FTP Server Details

Setup Item	Selectable Range or Selections	Default Value	Setting
Output Directory Format	MS-DOS/UNIX	MS-DOS	

Math

Setup Item	Selectable Range or Selections	Default Value	Setting
Value on Error	+Over/–Over	+Over	
Value on Overflow > SUM, AVE	Error/Skip/Limit	Skip	
Value on Overflow > MAX, MIN, P-P	Over/Skip	Over	

Report

Setup Item	Selectable Range or Selections	Default Value	Setting
Report select > 1	Max/Min/Ave/Sum/Inst	Ave	
Report select > 2	Off/Max/Min/Ave/Sum/Inst	Max	
Report select > 3	Off/Max/Min/Ave/Sum/Inst	Min	
Report select > 4	Off/Max/Min/Ave/Sum/Inst	Sum	
File type	Separate/Combine	Separate	

LOG Input

Setup Item	Selectable Range or Selections	Default Value	Setting
Display digits > Digits	2/3	3	
Input > LogType2	Linear/Pseudo	Linear	

End

Setup Item	Selectable Range or Selections	Default Value	Setting
Do you want to store and make the new settings take effect?	Yes/No/Cancel	–	

14.2 Basic Setting Mode Menu Map and Setup Items

Menu tab

Alarm > Basic settings

Setup Item	Selectable Range or Selections	Default Value	Setting
Reflash	On/Off	Off	
Rate of change > Decrease	1 to 32	1	
Rate of change > Increase	1 to 32	1	
Indicator	Hold/Nonhold	Nonhold	

Alarm > Switch, Relay

Setup Item	Selectable Range or Selections	Default Value	Setting
Internal Switch > AND	None/S01/S01-S02/. . . /S01-S29/S01-S30	None	
Relay > AND	None/I01/I01 to I02/. . . /I01 to I16 (depends on the options)	None	
Relay > Action	Energize/De_energ	Energize	
Relay > Hold	Hold/Nonhold	Nonhold	
Relay > Relay Action on Ack	Normal/Reset	Normal	

Alarm > Hysteresis

Setup Item	Selectable Range or Selections	Default Value	Setting
Meas CH > High/Low	Numerical value (0.0 to 5.0)	0.5	
Meas CH > Delta High/Low	Numerical value (0.0 to 5.0)	0.0	
Math channel > High/Low	Numerical value (0.0 to 5.0)	0.0	

A/D, Memory

Setup Item	Selectable Range or Selections	Default Value	Setting
Scan interval > Scan mode	Normal	Normal	
Normal > Scan interval	125ms/250ms (FX1002, FX1004)	125ms	
Normal > A/D integrate	1s/2s/5s (FX1006, FX1008, FX1010, FX1012)	1s	
Normal > A/D integrate	Auto/50Hz/60Hz/100ms	Auto	
Memory > Data kind	Display/E+D/Event	Display	

Burnout, RJC

Setup Item	Selectable Range or Selections	Default Value	Setting
First-CH, Last-CH	Channel number	001	
Burnout set	Off/Up/Down	Off	
RJC > Mode	Internal/External	Internal	
RJC > Volt	Numerical value (-20000 to 20000) μ V	0	

Keylock > Key action, Media

Setup Item	Selectable Range or Selections	Default Value	Setting
Password	8 characters or less	*****	
Key action > START	Free/Lock	Free	
Key action > STOP	Free/Lock	Free	
Key action > MENU	Free/Lock	Free	
Key action > USER	Free/Lock	Free	
Key action > DISP/ENTER	Free/Lock	Free	
Media/USB > External media	Free/Lock	Free	
Media/USB > Load settings	Free/Lock	Free	

Keylock > Action of Function

Setup Item	Selectable Range or Selections	Default Value	Setting
AlarmACK	Free/Lock	Free	
Message/Batch	Free/Lock	Free	
Math	Free/Lock	Free	
Data save	Free/Lock	Free	
E-mail/FTP	Free/Lock	Free	
Time set	Free/Lock	Free	
Display Function	Free/Lock	Free	

Login > Basic settings

Setup Item	Selectable Range or Selections	Default Value	Setting
Auto logout	Off/1min/2min/5min/10min	Off	
Operation without Login	Off/Display	Off	

Login > Admin settings

Setup Item	Selectable Range or Selections	Default Value	Setting
Admin number	Numerical value (1 to 5)	1	
Mode	Off/Key/Key+Comm/Comm*	Off	
User name	20 characters or less	For example, "Admin1"	
Password	8 characters or less	????????	

* This can only be selected when you are using communications to log onto the FX.

Login > User settings

Setup Item	Selectable Range or Selections	Default Value	Setting
User number	Numerical value (1 to 30)	1	
Mode	Off/Key/Comm/Web/Key+Comm	Off	
User name	20 characters or less	For example, "User1"	
Password	8 characters or less	????????	
Authority of user	Off/1/2/3/4/5/6/7/8/9/10	Off	

Login > Authority of user > Key action, Media

Setup Item	Selectable Range or Selections	Default Value	Setting
Authority of user	Numerical value (1 to 10)	1	
Key action > START	Free/Lock	Free	
Key action > STOP	Free/Lock	Free	
Key action > MENU	Free/Lock	Free	
Key action > USER	Free/Lock	Free	
Key action > DISP/ENTER	Free/Lock	Free	
Media/USB > External media	Free/Lock	Free	
Media/USB > Load settings	Free/Lock	Free	

Login > Authority of user > Action of Function

Setup Item	Selectable Range or Selections	Default Value	Setting
Authority of user	Numerical value (1 to 10)	1	
AlarmACK	Free/Lock	Free	
Message/Batch	Free/Lock	Free	
Math	Free/Lock	Free	
Data save	Free/Lock	Free	
E-mail/FTP	Free/Lock	Free	
Time set	Free/Lock	Free	
Display Function	Free/Lock	Free	

14.2 Basic Setting Mode Menu Map and Setup Items

Report > Basic settings

Setup Item	Selectable Range or Selections	Default Value	Setting
Report kind	Off/Hour/Day/Hour+Day/Day+Week/Day+Month	Off	
Date	Numerical value (1 to 28)	1	
Day of the week (Day+week)	SUN/MON/TUE/WED/THU/FRI/SAT	SUN	
Time (hour)	Numerical value (0 to 23)	0:00	

Report > Report settings

Setup Item	Selectable Range or Selections	Default Value	Setting
Report channel number	FX1002, FX1004: R01 to R12 FX1006, FX1008, FX1010, FX1012: R01 to R24	R01	
On/Off	On/Off	On (only for the meas channels, Off for all other channels)	
Channel	Channel number	Depends on the model	
Sum scale	Off, /s, /min, /h, /day	/s	

Time settings

Setup Item	Selectable Range or Selections	Default Value	Setting
Time zone (HHMM)	Numerical value (-1300 to 1300)	900	
Time deviation limit	Off/10s/20s/30s/1min/2min/3min/4min/5min	30s	
Date format	Y/M/D, M/D/Y, D/M/Y, D.M.Y	Y/M/D	

Communication (Ethernet) > IP-address

Setup Item	Selectable Range or Selections	Default Value	Setting
DHCP	Use/Not	Not	
DNS accession	Use/Not	Use	
Host-name register	Use/Not	Use	
Fixed IP-address > IP-address	Numerical value (0.0.0.0 to 255.255.255.255)	0.0.0.0	
Fixed IP-address > Subnet mask	Numerical value (0.0.0.0 to 255.255.255.255)	0.0.0.0	
Fixed IP-address > Default gateway	Numerical value (0.0.0.0 to 255.255.255.255)	0.0.0.0	

Communication (Ethernet) > Host settings

Setup Item	Selectable Range or Selections	Default Value	Setting
Host name	64 characters or less	-	
Domain name	64 characters or less	-	

Communication (Ethernet) > DNS settings

Setup Item	Selectable Range or Selections	Default Value	Setting
Server search order > Primary	Numerical value (0.0.0.0 to 255.255.255.255)	0.0.0.0	
Server search order > Secondary	Numerical value (0.0.0.0 to 255.255.255.255)	0.0.0.0	
Domain suffix search order > Primary	64 characters or less	-	
Domain suffix search order > Secondary	64 characters or less	-	

Communication (Ethernet) > Keepalive, Timeout

Setup Item	Selectable Range or Selections	Default Value	Setting
Keepalive	On/Off	On	
Application time out > On/Off	On/Off	Off	
Application time out > Time	Numerical value (1 to 120 minutes)	1	

Communication (Ethernet) > Server > Server modes

Setup Item	Selectable Range or Selections	Default Value	Setting
FTP	Use/Not	Not	
Web	Use/Not	Use	
SNTP	Use/Not	Not	
Modbus	Use/Not	Not	

Communication (Ethernet) > Server > Allowed Modbus clients

Setup Item	Selectable Range or Selections	Default Value	Setting
Use/Not	Use/Not	Not	
Client number	Numerical value (1 to 10)	1	
On/Off	On/Off	Off	
Allowed IP Address	Numerical value (0.0.0.0 to 255.255.255.255)	0.0.0.0	

Communication (Ethernet) > Web page

Setup Item	Selectable Range or Selections	Default Value	Setting
Page type	Operator/Monitor	Operator	
Page type = Operator			
Web page > On/Off	On/Off	Off	
Access control	Off/Admin	Off	
Command	Use/Not	Not	
Page type = Monitor			
On/Off	On/Off	Off	
Access control	Off/Admin/User	Off	

Communication (Ethernet) > E-Mail > Basic settings

Setup Item	Selectable Range or Selections	Default Value	Setting
SMTP server name	64 characters or less	-	
Port number	Numerical value (0 to 65535)	25	
Security	Off/PbS/Auth	Off	
SMTP authorization > User name (when Auth is selected)	32 characters or less	-	
SMTP authorization > Password (when Auth is selected)	32 characters or less	-	

Communication (Ethernet) > E-Mail > Recipients

Setup Item	Selectable Range or Selections	Default Value	Setting
Recipient 1	150 characters or less	-	
Recipient 2	150 characters or less	-	
Sender	64 characters or less	-	

Communication (Ethernet) > E-Mail > POP3 settings

Setup Item	Selectable Range or Selections	Default Value	Setting
POP3 Server name	64 characters or less	-	
Port number	Numerical value (0 to 65535)	110	
Login name	32 characters or less	-	
Password	32 characters or less	***** . . . ***	

14.2 Basic Setting Mode Menu Map and Setup Items

Communication (Ethernet) > E-Mail > Alarm settings

Setup Item	Selectable Range or Selections	Default Value	Setting
Recipient 1	On/Off	Off	
Recipient 2	On/Off	Off	
Active Alarms > Alarm 1	On/Off	Off	
Active Alarms > Alarm 2	On/Off	Off	
Active Alarms > Alarm 3	On/Off	Off	
Active Alarms > Alarm 4	On/Off	Off	
Include INST	On/Off	Off	
Include source URL	On/Off	Off	
Subject	32 characters or less	Alarm_summary	
Header 1	64 characters or less	-	
Header 2	64 characters or less	-	

Communication (Ethernet) > E-Mail > Scheduled settings

Setup Item	Selectable Range or Selections	Default Value	Setting
Recipient 1	On/Off	Off	
Interval	1h/2h/3h/4h/6h/8h/12h/24h	24h	
Ref.time	Numerical value (00:00 to 23:59)	00:00	
Recipient 2	On/Off	Off	
Interval	1h/2h/3h/4h/6h/8h/12h/24h	24h	
Ref.time	Numerical value (00:00 to 23:59)	00:00	
Include INST	On/Off	Off	
Include source URL	On/Off	Off	
Subject	32 characters or less	Periodic_data	
Header 1	64 characters or less	-	
Header 2	64 characters or less	-	

Communication (Ethernet) > E-Mail > System settings

Setup Item	Selectable Range or Selections	Default Value	Setting
Recipient 1	On/Off	Off	
Recipient 2	On/Off	Off	
Include source URL	On/Off	Off	
Subject	32 characters or less	System_warning	
Header 1	64 characters or less	-	
Header 2	64 characters or less	-	

Communication (Ethernet) > E-Mail > Report settings

Setup Item	Selectable Range or Selections	Default Value	Setting
Recipient 1	On/Off	Off	
Recipient 2	On/Off	Off	
Include source URL	On/Off	Off	
Subject	32 characters or less	Report_data	
Header 1	64 characters or less	-	
Header 2	64 characters or less	-	

Communication (Ethernet) > FTP Client > FTP transfer file

Setup Item	Selectable Range or Selections	Default Value	Setting
FTP transfer file > Disp&Event data	On/Off	Off	
FTP transfer file > Report	On/Off	Off	
FTP transfer file > Snapshot	On/Off	Off	

Communication (Ethernet) > FTP Client > FTP connection

Setup Item	Selectable Range or Selections	Default Value	Setting
FTP connection	Primary/Secondary	Primary	
FTP server name	64 characters or less	-	
Port number	Numerical value (0 to 65535)	21	
Login name	32 characters or less	-	
Password	32 characters or less	*****...***	
Account	32 characters or less	-	
PASV mode	On/Off	Off	
Initial path	64 characters or less	-	

Communication (Ethernet) > Sntp client

Setup Item	Selectable Range or Selections	Default Value	Setting
Use/Not	Use/Not	Not	
Server name	64 characters or less	-	
Port number	Numerical value (0 to 65535)	123	
Access interval	Off/1h/8h/12h/24h	8h	
Access reference time	Numerical value (00:00 to 23:59)	00:00	
Access timeout	10s/30s/90s	30s	
Time adjust on Start action	On/Off	Off	

Communication (Ethernet) > Modbus client > Basic settings

Setup Item	Selectable Range or Selections	Default Value	Setting
Read cycle	1s/2s/5s/10s	1s	
Retry interval	Off/10s/20s/30s/1min/2min/5min/10min/20min/30min/1h	2min	

Communication (Ethernet) > Modbus client > Modbus server settings

Setup Item	Selectable Range or Selections	Default Value	Setting
Server number	1-8/9-16	1-8	
Port	Numerical value (0 to 65535)	502	
Modbus server name	64 characters or less	-	
Unit	Auto/Fixed	Auto	
No.	0 to 255	1	

Communication (Ethernet) > Modbus client > Command settings

Setup Item	Selectable Range or Selections	Default Value	Setting
Client command number	1-8/9-16	1-8	
1 to 16	Off/R-M/W/W-M	Off	
First	Depends on the command type	-	
Last	Depends on the command type	-	
Server	1/2/3/. . . /15/16	1	
Regi.	Numerical value (register number)	30001	
Type	INT16/UINT16/INT32_B/INT32_L/UINT32_B/ UINT32_L/FLOAT_B/FLOAT_L	INT16	

14.2 Basic Setting Mode Menu Map and Setup Items

Communication (Serial) > Basic settings

Setup Item	Selectable Range or Selections	Default Value	Setting
Baud rate	1200/2400/4800/9600/19200/38400	9600	
Data length	7/8	8	
Parity	Odd/Even/None	Even	
Handshaking	Off:Off/XON:XON/XON:RS/CS:RS	Off:Off	
Address	Numerical value (1 to 99)	1	
Protocol	Normal/Modbus/Modbus-M	Normal	

Communication (Serial) > Modbus master > Basic settings

Setup Item	Selectable Range or Selections	Default Value	Setting
Read cycle	1s/2s/5s/10s	1s	
Timeout	125ms/250ms/500ms/1s/2s/5s/10s/1min	1s	
Retrials	Off/1/2/3/4/5/10/20	1	
Inter-block delay	Off/5ms/10ms/15ms/45ms/100ms	Off	
Auto recovery	Off/1min/2min/5min/10min/20min/30min/1h	2min	

Communication (Serial) > Modbus master > Command settings

Setup Item	Selectable Range or Selections	Default Value	Setting
Master command number	1-8/9-16	1-8	
1 to 16	Off/R-M/W/W-M	Off	
First	Depends on the command type	-	
Last	Depends on the command type	-	
Addr.	Numerical value (1 to 247)	1	
Regi.	Numerical value (register number)	30001	
Type	INT16/UINT16/INT32_B/INT32_L/UINT32_B/ UINT32_L/FLOAT_B/FLOAT_L	INT16	

Status relay

Setup Item	Selectable Range or Selections	Default Value	Setting
Memory/Media status	On/Off	Off	
Measurement error	On/Off	Off	
Communication error	On/Off	Off	
Memory stop	On/Off	Off	

Power

Setup Item	Selectable Range or Selections	Default Value	Setting
Phase and wire system	1P2W (single-phase two-wire system), 1P3W (single-phase three-wire system), 3P3W (three- phase three-wire system)	3P3W	
Input voltage	120V/240V	240V	

End

Setup Item	Selectable Range or Selections	Default Value	Setting
Do you want to store and make the new settings take effect?	Yes/No/Cancel	-	

File/Initialize tab**Load settings**

Setup Item	Selectable Range or Selections	Default Value	Setting
Kind	CF/SD/USB (depends on the options)	CF/SD	

Initialize

Setup Item	Selectable Range or Selections	Default Value	Setting
Kind	Clear 1/Clear 2/Clear 3	Clear 3	

Media eject

Setup Item	Selectable Range or Selections	Default Value	Setting
Media eject	CF/SD/USB (depends on the options)	-	

End

Setup Item	Selectable Range or Selections	Default Value	Setting
Do you want to store and make the new settings take effect?	Yes/No/Cancel	-	

Appendix 1 File Size of Display Data and Event Data

The maximum size of a single display data file or event data file is 8 MB. This section takes a look at some data recording cases and calculates the approximate sampling time required to create an 8 MB file for each case. Use this as a guideline for the sampling time of a single data file.

Sampled Data Size

- Data Size of Display Data and Event Data**

Channel	Display Data	Event Data
Measurement channel	4 bytes/channel	2 bytes/channel
Computation channel	8 bytes/channel	4 bytes/channel

Time data common to all channels is added for each sample.

Time data	8 bytes/sample
-----------	----------------

- Data Size per Sample**

Display Data

(Number of measurement channels×4 bytes) + (number of computation channels×8 bytes) + 8 bytes (time data)

Event Data

(Number of measurement channels×2 bytes) + (number of computation channels×4 bytes) + 8 bytes (time data)

Sampling Time for a Single File (8 MB)

The sampling time for a single file (8 MB) is calculated as follows:

Number of samples × sampling interval.

The number of samples is calculated as follows:

8 MB/(the data size per sample)

Only Display Data

If the display data from the 12 measurement channels and the 24 computation channels is recorded at the trend interval of 30 min/div and the display data's sampling interval is 60 seconds:

Number of samples

= 8 MB/(8 bytes + 12 × 4 bytes + 24 × 8 bytes) = Approximately 32,258 samples

Sampling time per file (8 MB)

= 32,258 × 60 seconds = 1,935,480 seconds = Approximately 22 days

Only Event Data

If the event data from the 12 measurement channels and the 24 computation channels is recorded at the sampling interval of 1 second:

Number of samples

= 8 MB/(8 bytes + 12 × 2 bytes + 24 × 4 bytes) = Approximately 62,500 samples

Sampling time per file (8 MB)

= 62,500 × 1 seconds = 62,500 seconds = Approximately 17 hours

Appendix 1 File Size of Display Data and Event Data

Display data and event data

Display data file size = 8 MB

Event data file size = 8 MB

You can use these figures to calculate the sampling time per file in the same manner as was used for the case of “only display data” or “only event data.”

You can save multiple files such as those described above to the internal memory or to an external memory device (the number of files that can be stored is limited by the size of the internal memory or external memory device).

Calculation Examples of the Sampling Time for a Single File (8 MB)

Examples of the sampling time for a single file (8 MB) are shown below. You cannot actually set recording conditions so that the sampling time exceeds 31 days. If the sampling time exceeds 31 days, the file will be divided even if it is not 8 MB in size.

4 Measurement Channels and No Computation Channels

Display data file

Trend interval (time/div)	15 s	30 s	1 min	2 min	5 min	10 min
Sampling interval	0.5 s	1 s	2 s	4 s	10 s	20 s
Sampling time (approx.)	42.7 hours	3 days	7 days	14 days	35 days (-> 31 days)	71 days (-> 31 days)

Event data file

Sampling interval	125 ms	0.5 s	1 s	2 s	5 s	10 s
Sampling time (approx.)	15.4 days	2 days	5 days	10 days	25 days	51 days (-> 31 days)

12 Measurement Channels and 24 Computation Channels

Display data file

Trend interval (time/div)	30 s	1 min	5 min	10 min	30 min	1 hour
Sampling interval	1 s	2 s	10 s	20 s	1 min	2 min
Sampling time (approx.)	9 hours	17.9 hours	3 days	7 days	22 days	44 days (-> 31 days)

Event data file

Sampling interval	1 s	2 s	5 s	10 s	30 s	1 min
Sampling time (approx.)	17.3 hours	1.4 days	3.6 days	7.2 days	21 days	43 days (-> 31 days)

Appendix 2 Types of Data Files That the FX Can Create and How They Can Be Used

This section will explain the types of data files that the FX can create and how they can be used.

Data Type	Extension	Format	Display Method ¹		
			FX	DAQ	Application
Display data	DAD	Binary (undisclosed)	Yes	Yes	Yes ²
Event data	DAE	Binary (undisclosed)	Yes	Yes	Yes ²
Report data	DAR	Text (see appendix 3)	-	Yes	Yes
Manual sampled data	DAM	Text (see appendix 3)	-	-	Yes
Setup data	PDL	Binary (undisclosed)	-	Yes	-
Snapshot data	PNG	PNG (general format)	-	-	Yes

1 FX: FX main unit, DAQ: DAQSTANDARD, Application: Software application.

2 The data format can be converted on DAQSTANDARD and displayed on a software application such as Microsoft Excel.

Appendix 3 Text File Data Format

This section explains the format of text files. The FX can create the following text files: manual sampled data files and report files.

In the explanation below, CRLF represents a terminator.

Format of the Manual Sample Data File

- The manual sampled data is output using numerical values and strings in text format delimited by tabs.
- Values of measurement channels set to **Skip** and computation channels set to **Off** are not output.
- The data is appended to the file each time manual sample operation is performed.

Format

```
YRECCRLF
Manual Sample Data  Version 1.01.00CRLF
Model                FX1000CRLF
Language Code       shift-JIS  CRLF
File Status         ffffffff  CRLF
Serial No.          III...I    CRLF
File Header         HHH...H    CRLF
Ch                  ccccc   ccccc   ...   cccccCRLF
Tag                 ttt...t   ttt...t   ...   ttt...tCRLF
Unit                uuuuuu   uuuuuu   ...   uuuuuuCRLF
yyyy/mo/dd hh:mi:ss nnn...n   nnn...n   ...   nnn...nCRLF
```

fffffff

File status (8 characters)

Complete Completed. (A file with 100 manually sampled data acquisitions that is now complete.)

Progress Data is being added. (An incomplete file that does not yet have 100 manually sampled data acquisitions.)

Decrease The file is defective. (A file that is missing some of the manually sampled data that was stored on it.)

III...I

Serial number of the FX (16 characters)

HHH...H

File header (50 characters)

ccccc

Channel number (5 characters)

ttt...t

Tag (16 characters)

uuuuuu

Unit (6 characters)

yyyy/mo/dd hh:mi:ss

Sampling year, month, day, and time (19 characters)

nnn...n

Measured value (13 characters)

File Output Example

Below is a manual sample data example of channels 1, 2, 3, and 4.

```

YREC
Manual Sample Data   Version 1.00.00
Model                FX1000
Language Code        shift-JIS
File Status           Progress
Serial No.           S5E701600
File Header
Ch                   CH001      CH002      CH003      CH004
Tag                  abc        def        hij        klmn
Unit                 °C        V          m3/h      %
2005/10/01 08:57:22 213.8     0.517     368.4     68.9
2005/10/01 08:57:28 208.6     0.494     363.0     68.1
    
```

Note

- Output when error data, overrange data, or computation overflow data is detected

Channel	Data	Output
Measurement channels	Error	(Space)
	+over range (includes burnout detection)	99999
	-over range (includes burnout detection)	-99999
Computation channel	Error	999999999
	Positive computation overflow (when the value exceeds 99999999)	999999999
	Negative computation overflow (when the value falls below -99999999)	-999999999
	The decimal place that was specified when the span for the channel was specified applies to the output values. For example, if the span setting of the channel is "200.0," then "999999999" is output when the value exceeds "999999.9" and "-999999999" is output when the value is below "-999999.9."	

- A new manual sampled data file is created in the following cases.
 - A measurement channel is changed to **Skip** from a range other than **Skip**.
 - A measurement channel is changed from **Skip** to a range other than **Skip**.
 - A computation channel is changed from **On** to **Off** or **Off** to **On**.
 - The unit is changed.

Report File Format

- The hourly, daily, weekly, and monthly reports are output using numeric values and strings in text format delimited by tabs.
- Values of measurement channels set to **Skip** and computation channels set to **Off** are not output.
- The data is appended to this file every time a report is created.

Format

```

YRECCRLF
Report Data      Version 1.00.00CRLF
Model            FX1000CRLF
Language Code    shift-JIS CRLF
File Status      ffffffff CRLF
Serial No.       III...I CRLF
File Header      HHH...H CRLF
Report Set       RRR...R CRLF
File Data        rrr...r CRLF
Math Set         MMM      MMM      MMM      MMMCRLF
Start Time       YYYY/MO/DD HH:MI:SS CRLF
Ch               ccccc  ccccc  ...  cccccCRLF
Tag              ttt...t  ttt...t  ...  ttt...tCRLF
Unit             uuuuuu  uuuuuu  ...  uuuuuuCRLF
Data Type        sss...s CRLF
Time             yyyy/mo/dd hh:mi:ss CRLF
Status           eeeeeeeee CRLF
Ave              nnn...n  nnn...n  ...  nnn...nCRLF
Max              nnn...n  nnn...n  ...  nnn...nCRLF
Min              nnn...n  nnn...n  ...  nnn...nCRLF
Sum              nnn...n  nnn...n  ...  nnn...nCRLF
    
```

fffffff

File status (8 characters)

- Complete Completed. (A file with the necessary number of acquisitions for its report type, for example one acquisition for an Hourly report type, that is now complete.)
- Progress Data is being added. (An incomplete file that does not yet have the necessary number of acquisitions for its report type.)
- Decrease The file is defective. (A file that is missing some of the report data that was stored on it.)

III...I

Serial number of the FX (16 characters)

HHH...H

File header (50 characters)

RRR...R

Report setting (setting on the FX) (13 characters)

- Hourly
- Daily
- Hourly+Daily
- Daily+Weekly
- Daily+Monthly

<pre> rrr...r </pre>	<p>Contents of the report file (13 characters)</p> <p>Hourly Daily Hourly+Daily Daily+Weekly Daily+Monthly</p> <p>Example: When the FX is set to Hourly+Daily and Combine, Hourly+Daily is output. When the FX is set to Hourly+Daily and Separate, the hourly report is output as Hourly, and the daily report as Daily.</p>
<pre> MMMM </pre>	<p>Report items (16 characters (including tabs that are counted as one character each), up to four types)</p> <p>Ave Max Min Sum Inst Instantaneous value</p>
<pre> YYYY/MO/DD HH:MI:SS cccc ttt...t uuuuuu eeeeeeeeee </pre>	<p>Report start year, month, day, and time (19 characters)</p> <p>Channel number (5 characters)</p> <p>Tag (16 characters)</p> <p>Unit (6 characters)</p> <p>Status (output the events that occurred while creating report data) (10 characters)</p> <p>Bo Burn out detected Er Error (error detection) Ov Over (overrange/computation overflow detection) Pw Power failure (power failure occurrence) Cg Change (time change present)</p>
<pre> SSS...S </pre>	<p>Report type (7 characters)</p> <p>Hourly Daily Weekly Monthly</p>
<pre> yyyy/mo/dd hh:mi:ss nnn...n </pre>	<p>Report year, month, day, and time (19 characters)</p> <p>Average, maximum, minimum, sum, or instantaneous value (13 characters)</p>

Appendix 3 Text File Data Format

File Output Example

Below is an example of an hourly report of 4 channels while creating hourly and daily reports and saving each type of report to a separate file.

```
YREC
Report Data      Version 1.00.00
Model           FX1000
Language Code   shift-JIS
File Status     Complete
Serial No.      S5E701600
File Header
Report Set      Hourly+Daily
File Data       Hourly
Math Set        Ave           Max           Min           Sum
Start Time     2005/10/01 08:10:56
Ch             CH001           CH002           CH003           CH004
Tag            abc             def             hij             klmn
Unit           °C             V               m3/h           %
Data Type      Hourly
Time           2005/10/01 09:00:00
Status
Ave            91.5           -0.039          241.1           48.6
Max            259.8          0.726           416.5           76.6
Min            -59.9          -0.727          83.4            23.3
Sum            3.293636E+05  -1.392980E+02  8.680871E+05   1.748983E+05
```

Note

- When the channel data is in the condition shown in the table below, the *Er*, *Ov*, or *Bo* status is output to a report.

Data Condition	Status
Error	Er
Measurement channels	
Positive over range	Ov
Negative over range	Ov
Burn out detection	Bo
Computation channels	
Positive computation overflow (when the value exceeds 1.79E + 308)	Ov
Negative computation overflow (when the value falls below -1.79E + 308)	Ov

- The report output value of *Ave*, *Max*, *Min*, *Sum*, and *Inst* varies depending on the channel data condition as shown in the table below.

Item	Data Condition of Measurement Channels	Report Output Value
<i>Ave</i>	When all of the data are errors or over range	(Space)
<i>Max</i> ,	<ul style="list-style-type: none"> When all of the data are errors For +over range (includes burnout detection) For -over range (includes burnout detection) 	(Space)
<i>Min</i> ,		99999
<i>Inst</i>		-99999
<i>Sum</i>	<ul style="list-style-type: none"> When all of the data are errors or over range When the sum value exceeds approx. 3.4E + 38 When the sum value is below approx. -3.4E + 38 	(Space)
		9.999999E+99
		-9.999999E+99

Item	Data Condition of Computation Channels	Report Output Value
<i>Ave</i>	When all of the data are errors or computation overflow	(Space)
<i>Max</i> ,	<ul style="list-style-type: none"> When all of the data are errors When the maximum value or instantaneous value exceeds 99999999* When the minimum value or instantaneous value is less than -99999999* 	(Space)
<i>Min</i> ,		999999999
<i>Inst</i>		-999999999
<i>Sum</i>	<ul style="list-style-type: none"> When all of the data are errors or computation overflow When the sum value exceeds approx. 3.4E + 38 When the sum value is below approx. -3.4E + 38 	(Space)
		9.999999E+99
		-9.999999E+99

* The decimal place that was specified when the span for the channel was specified applies to the maximum and minimum values or the instantaneous values. For example, if the span setting of the channel is "200.0," then "999999999" is output when the value exceeds "9999999.9" and "-999999999" is output when the value is below "-999999.9."

Index

Symbols

**	9-7
[a?b:c]	9-11
-Over	1-14
+Over	1-14
3 leg isolated RTD input	13-11
24 VDC transmitter power supply	13-13
24 V power supply	13-14

A

ABS	9-7
absolute time mode	1-34
action	1-35
Active or regenerative electric power	3-21
Active power	3-21
added messages	1-16
A/D integration time	3-1
administrator	1-39, 8-5
alarm	1-5, 13-2
alarm ACK	1-8
alarm delay time	9-3
alarm hide function	1-6
alarm indication	1-6
alarm mark indication	5-14
alarm output relay	1-7, 3-9, 13-10
alarm settings	3-12
alarm summary	1-17, 4-19
alarm value	3-13
all channel	4-13
all channel display	4-6, 4-13
all data display	4-12
AND	9-8
AND/OR	1-7
Apparent power	3-21
auto increment	6-7
auto logout	1-39, 8-4, 8-6
automatic message writing	1-12
auto save	1-28, 6-5
auto scroll	4-6

B

background color	1-22, 5-22
background color (historical trend)	4-15
backlight saver	1-22, 2-8
bar graph, base position	5-19
bar graph display	1-15, 4-4
batch comment	1-32, 6-7
batch function	6-7, 13-9
batch name	6-7
brightness	1-22, 2-8
burnout	1-14, 3-2
burnout Detection	1-2

C

calibration	11-2
calibration correction	1-3, 3-16, 13-13
CARRY	9-11
CF card	1-28
change message	5-4
changing settings during recording	6-12
channel (computation)	1-40
channel display colors	5-9

channel number	5-3
CLOG computation	9-10
color scale band	5-15
comma	2-14
communication application errors	10-6
communication errors	10-12
communication functions	13-10
communication log	4-26
computation channel	9-1
computation data dropout	1-43, 9-16
computation error	9-4
computation function	1-40, 13-11
computations, reset	9-16
computation types	1-40
conditional expression	9-11
configuration (storage)	13-6
constant	3-18, 3-24, 9-1
construction	13-17
continuing data	4-11
count (moving average)	3-7
creating data files	1-29
CT Ratio	3-23
current value display	5-13
cursor (historical trend)	4-11
cursor time	4-14
customizing the menus	1-21, 4-3

D

data display section	1-9
data file loading	13-7
data kind	6-2
data length	6-3
data save mode	2-13, 4-23
data that can be used in equations	1-42
data type	13-6
data types	1-23
date format	1-49, 2-4
date/time	2-1
decimal point type	2-14
de-energize	1-8
delay high limit alarm	1-5
delay low limit alarm	1-5
deleting a file	6-16
detect (alarm hide function)	3-14
DHCP log	4-28
difference computation	1-3
difference lower limit alarm	1-5
difference upper limit alarm	1-5
digital display	1-14, 4-4
digit (scale value)	5-13
directory (data save)	1-28
display color (channels)	5-9
display color (messages)	5-8
display data	1-23, 1-25, 13-6
display direction (bar graphs)	5-19
display direction (messages)	5-18
display direction (trend)	5-18
displayed information	13-3
displayed language	1-50
display group	5-1
display (LCD)	13-3
display menu	4-1, 5-28
display, parts of	1-9

Index

display selection menu 4-1, 5-28
display zone 5-10
divided (report file) 9-18
division (scale) 5-12
DST (daylight saving time) 1-50, 2-1
data files that the FX can create App-3

E

effects of operating conditions 13-20
e-mail log 4-27
energize 1-8
EQ 9-7
error codes 10-1
error data 1-46
error log 4-26
error messages 10-1
errors related to parameter settings 10-1
event 1-33
event action 1-33, 7-1, 13-8
event data 1-23, 1-25, 13-6
EXP 9-7
exponent 3-30
expressions (computation) 9-5
extended input type 13-12
extension (file) 1-30
external dimensions 13-21
external storage medium 1-28

F

FAIL output 1-47, 2-10
FAIL/status output relay 13-11
file header 6-5
file list display 6-15
firmware version 2-5
fixed (alarm mark) 5-14
flag 1-42
flow of data recording and storage 1-24
formatting 6-16
format type 6-16
four arithmetic operation 9-7
free (event data) 1-26, 6-3
free messages 1-12, 5-8
free space 6-16
FTP log 4-26
Function menu 4-2

G

GE 9-7
gradually correcting the internal clock 1-49
graph display 1-9
grid 5-18
groups 5-1
group set 5-1
GT 9-7

H

historical trend display 1-16, 4-8
HOLD 9-11
hold (alarm indication) 1-6
hold (alarm output relay) 1-8
hysteresis 1-5, 3-10

I

identified strings 6-5
indicator 3-9
information on the displayed measured data 4-15

initialize 2-9
input processing 1-2
input range 3-3
input type 1-1, 3-5
integration time 1-1
internal memory 1-24
internal switch 1-8, 1-33, 3-9
interval (rate-of-change alarm) 1-5, 3-8
invalid keys 2-12
isolation 13-18

J

jump default display 5-24

K

key lock 1-38, 8-1

L

LAG 3-21
LCD 1-9
LE 9-7
LEAD 3-21
limitations (expressions) 9-6
linear scaling 1-3
line width of the trend 5-18
LN 9-7
loading a file 6-17
loading setup data 6-19
LOG 9-7
Logarithmic DC voltage 1-1
log display 1-21
logging in 8-6
logging out 8-6
logical computation 9-8
login function 1-39
login log 4-25
Log input 3-28
log into the FX 8-6
Log linear input 3-28
log scale (logarithmic scale) 3-28
LogType1 3-30
LogType2 3-31
lot-No. digit 6-7
lot number 1-32
low-cut 1-3, 3-6
Low-cut power 3-23
LT 9-7

M

MAC address 2-5
maintenance 11-1
maintenance and test communication command errors 10-13
mantissa 3-31
manuals i
manual sampled data 1-23, 1-27, 6-13, 13-7
manual sampled data (format) App-4
manual save 1-29
match time timer 1-33, 7-3
math start action 9-15
measurement channel 1-1
measurement input 13-1
measure soft key 3-16
media FIFO 1-29, 6-5
memory backup 13-20
memory sample 6-2
memory start 6-9
memory stop 6-11

- memory summary 1-19, 4-22
message colors 5-8
message display 4-6, 4-13
message display methods 4-21
messages 1-12, 5-6
messages (errors, status, etc) 10-1
message summary 1-18, 4-20
modbus status display 4-18
modbus status log 4-28
Modbus master status display 1-21
mode (input range) 3-4
moving average 1-2
- ## N
- NE 9-7
network information screen 2-5
next soft key 4-2
No logging 3-11
non-hold (alarm indication) 1-6
non-hold (alarm output relay) 1-8
Nonlinear Log Input 3-28
normal operating conditions 13-17
NOT 9-8
number of pulses per minute 3-18
numeric display 1-14, 4-6
- ## O
- operation errors 10-5
operation logs 4-25
operations that can be carried out when logged out 1-39
OR 9-8
order of precedence (computation) 9-6
overflow data 1-46, 9-4
overview display 1-17, 4-16
- ## P
- partial expanded display 1-13, 5-16
password change 8-7
Phase and wire system 3-23
point 2-14
power computations 9-7
power factor 3-21
power-fail message 5-25
power failure operation 1-46
power monitor function 3-21
power supply 13-17
power supply for transmitter 1-50
PRE 9-11
preset display 5-24
pre-trigger 6-3
pretrigger 1-26
processing order of computation 1-42
progress of the save operation 4-24
Pseudo Log Input 3-28
pulse input 1-3, 13-13
pulse sum value 3-17
- ## R
- range (input range) 3-5
rate-of-change alarm 1-5
Reactive power 3-21
recording conditions (display data) 1-25
recording conditions (event data) 1-26
ref. CH 3-6
reference junction compensation 1-2, 3-2
reflash 1-7, 3-8
Regenerative electric power 3-21
relational computation 9-7
relative time mode 1-34
Relay Action on Ack 3-9
relay, deactivated time 1-7
relay status display 1-21, 4-18
releasing the key lock 8-2
remote control function 1-33
remote controller ID 2-5
remote control (/R1) 13-12
repeat (event data) 1-26
report 9-17
report channel 9-19
report data 1-23, 1-27, 13-7
report display 4-17
report file (format) App-6
report function 1-45
report group 9-19
RESET 9-11
resets the computed result (Rst+St) 9-15
reset the sum value 3-18
resetting the computed results 9-16
resetting the relative timer 7-4
reset (TLOG) 1-44
revisions ii
rolling average 1-43, 9-4
RS-232 interface 13-10
RS-422A/485 interface 13-10
- ## S
- sample rate 6-3
save directory 6-5
save interval 6-2
saving measured data (automatically) 6-9
saving measured data (manually) 6-10
saving setup data 6-18
saving the data 4-23
scale 4-6, 4-13, 5-11
scale lower 3-5
screen image data 1-23, 6-14
scroll time 5-23
SD card 1-28
secondary interval 5-5
security 8-4
security function 13-8
selecting a bar 4-31
separators 5-27
setup data 1-23, 1-31
single/dual graph display 4-30
single (event data) 1-26
single-phase three-wire system 3-23
single-phase two-wire system 3-23
snapshot 6-14, 13-7
snapshot data 1-23, 1-31
SNTP log 4-28
sort item 4-19
span lower 3-5
Special computation 9-11
special data 1-46
SQR 9-7
square root computation 1-3
stacked bar graph 1-20, 4-29
standard display soft key 5-24
standard performance 13-19
standards 13-18
standard temperature device 11-2
starting the computation 9-15
start the recording 6-9
status display section 1-10

Index

status messages..... 10-14
status output 1-47, 2-10
status relay 2-10
stopping the recording 6-11
storage media, formatting 6-16
structure of the file name 6-5
sub menu 4-1, 5-28
sum scale 1-45
symbols that can be entered 2-12
system display 1-50
system errors 10-16

T

tag 5-3
tag detail 4-6
tag display 4-1
temperature unit 3-3
text field 1-32, 6-7
text file data format App-4
three-phase three-wire system 3-23
time at the grid position 5-5
time axis 4-14
time deviation limit 2-3
timer 1-34, 7-3
timer action 7-3
time related functions 13-8
time set 2-1
time zone 1-49, 2-2
TLOG 9-3
TLOG computation 1-43, 9-9
trademarks ii
transport and storage conditions 13-18
trend display 4-4
trend display (T-Y) 1-11
trend history 4-8
trend interval 1-12, 5-4, 6-2
trend rate switching 5-4
trend sapce 4-7
trigger 6-9
trigger signal 6-3
trip line 5-2
troubleshooting 10-17
types of characters 13-8

U

unit in computations 1-42
unsaved data 1-29
update interval (measured values) 1-9
updating of the waveform 1-12
USB flash memory 2-13
USB interface 1-50, 13-13
user 1-39, 8-5
USER key 1-33, 7-1

V

value indicator 5-13
value on over-range 3-20
VT Ratio 3-23

W

warning messages 10-16
web log 4-27

X

XOR 9-8

Z

zone display 1-13