



www.daqstation.com

DXAdvanced R4

DX1000/DX2000

Daqstation

Bulletin 04L41B01-01E

www.daqstation.com

vigilantplant.[™]
The clear path to operational excellence

YOKOGAWA ◆

The debut of DXAdvanced R4 is here!

DXAdvanced R4

Evolved features for greater utility

The evolution of the global standard in paperless recorders has reached the next stage – the DAQSTATION DXAdvanced series R4 (release 4). Its basic functions have been further enhanced with an expanded security function option providing FDA 21 CFR Part 11 compliance, making it ideal for a broadening range of applications, such as in pharmaceutical manufacturing.

Basic Functions



- Up to 48 channels of input
- User can start/stop recording by batch, and create data files!
- Expandable to up to 348 channels with the MW100 automatic connection function
- **Internal memory increased to 400 MB**
- **Enables control of calibration correction scheduling** **R4**
- **Automatically creates template-based Excel spreadsheets** **R4**

Display & Operation



- Arrange the display your way with a custom display function!
- Review historical data with date and time calendar search functions

Networking



- Standard Ethernet interface
- Supports the PROFIBUS-DP and EtherNet/IP protocols!
- Expanded Web and networking functions!

Reliability and Security



- **21 CFR Part 11 compliance with an advanced security function option** **R4**
- Dust- and splash-proof front panel (IP65, NEMA4 compliant)
- Highly reliable internal memory with error-correction function
- Front panel door lock and login function

Application Software



- Software for a variety of tasks including analysis, settings, and acquisition
- DAQSTANDARD:**
Supports settings and data file analysis
- DAQStudio:**
Builder software for custom displays
- DAQWORX:**
Integrated Data Acquisition Software Suite
- DAQManager:**
Data management Software



DX1000

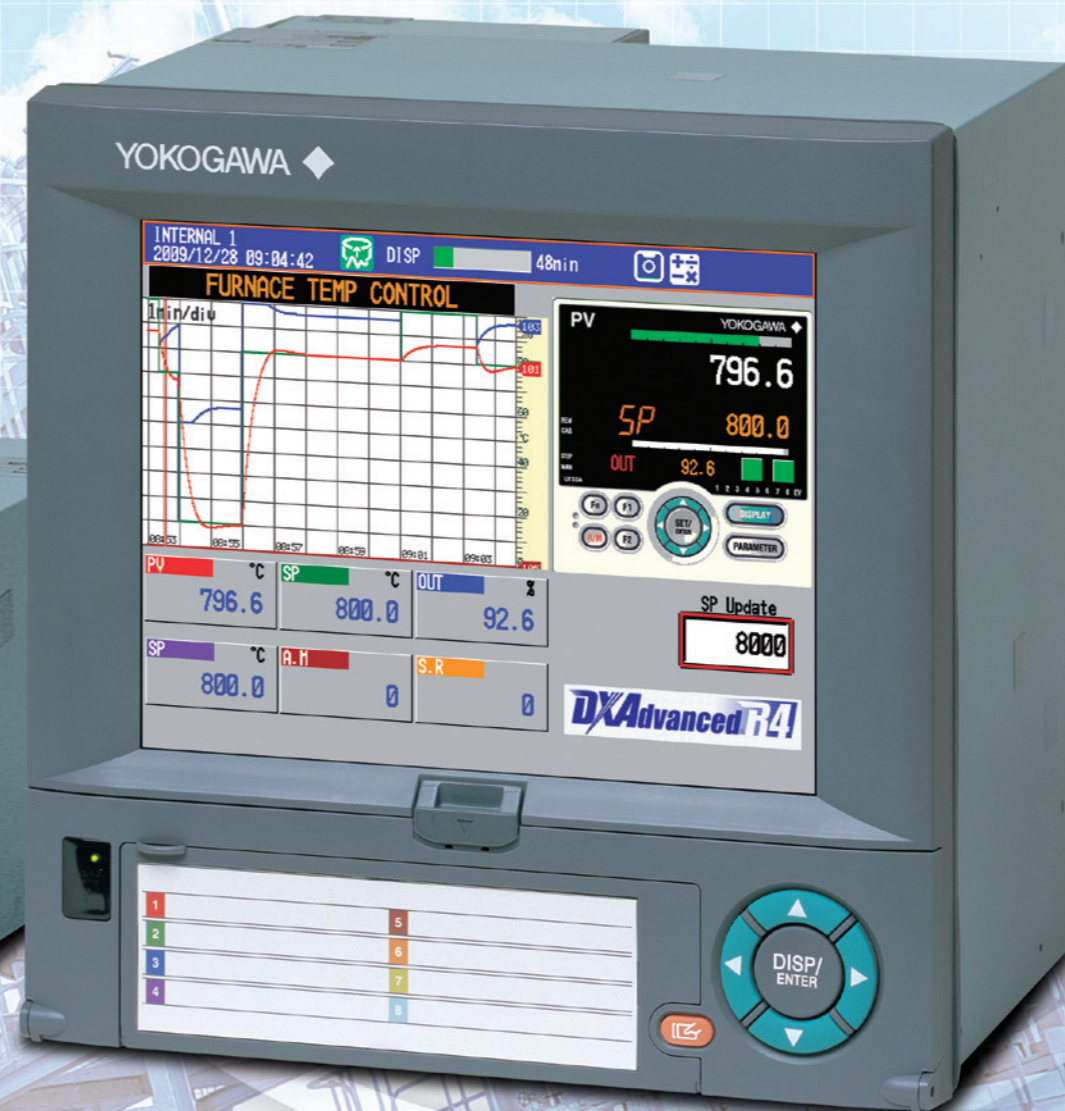

DX2000



Basic Functions – Universal inputs, with multi-batch, high capacity recording

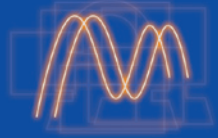

Offers accuracy, long-duration, and scalability when acquiring data in the field. Plus, it enables asynchronous data acquisition by measurement group. Supports a wide variety of applications, offering greater added value.

Multi-channel Measurement and Recording

The DX1000 and the DX2000 provide up to 12 or 48 Universal input channels respectively, providing high performance standalone recording functions. It can be used in various applications as an easy to use, traditional paperless recorder.

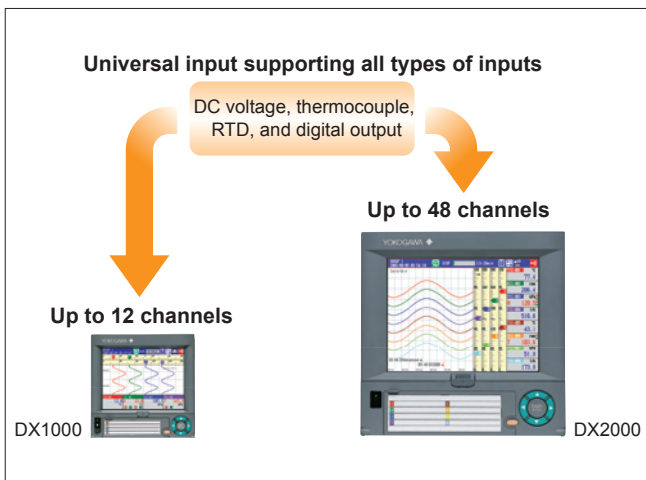

Multi-batch Function

Record pre-defined channel groups to separate data files with independent start and stop control. You can create up to 6 (DX1000) or 12 (DX2000) batches.

* Only 6 batches can be created on the DX2000 with the standard memory.

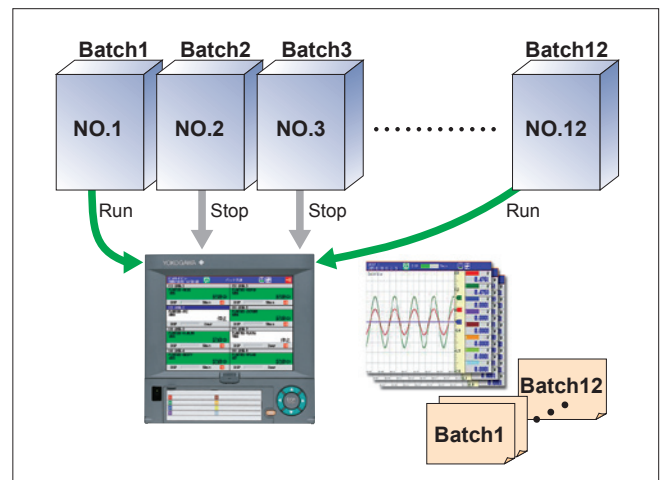

Scalable, High Input Capacity via External I/O

Using Modbus TCP communications, Yokogawa's MW100 data acquisition platform and other vendor's I/O products can be the source of many additional input channels. In this manner, up to 240 external channels can be input to DXAdvanced. Using optional math channels, 60 additional external inputs can be acquired for a total of 300. Start small and scale up your system by adding additional MW100 input modules, as you need them.

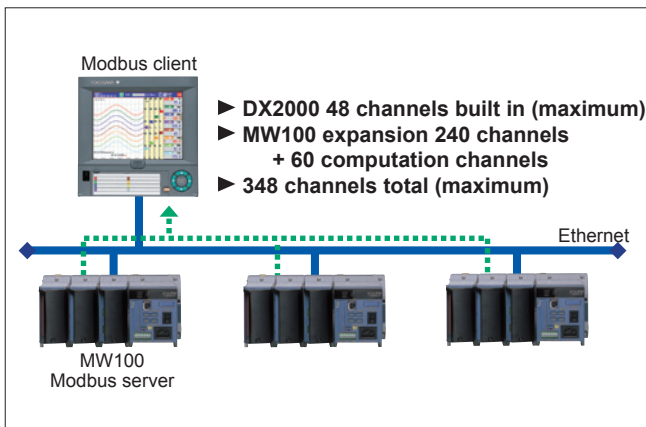

High Speed Measurement

A new fast sampling mode on 2, 4, and 8 input DXAdvanced models provides a scan interval of 25 ms. All other models support a 125 ms scan speed in this mode. This capability allows all DXAdvanced models to capture and record fast-transient input signals.

Model	High-Speed Scan Interval (Fast sampling mode)	High-Speed Scan Interval (Normal mode)
DX1002, DX1004 DX2004, DX2008	25 ms	125 ms
DX1006, DX1012 DX2010~DX2048	125 ms	1 s

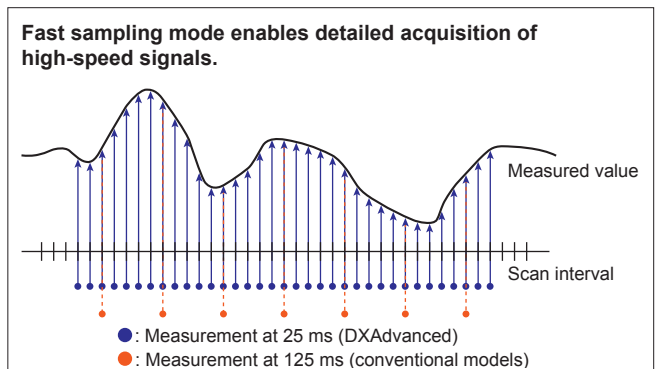

High Capacity Internal Memory

Standard-equipped internal memory greatly increased (to 400 MB). Even longer recording durations, and multichannel recording.

Display data file sample time

Measurement CH = 30 channels. Computation CH = 0 channels.

	DX2000 (400 MB)
Display update (minute/div)	30 minutes
Sampling period (s)	60 s
Total sample time	Approx. 5 years

Event data file sample time

Measurement CH = 30 channels. Computation CH = 0 channels.

	DX2000 (400 MB)
Sampling period (s)	1 s
Total sample time	Approx. 2 months

CompactFlash Removable Storage Media

All DXAdvanced models include a CompactFlash drive. Rugged and readily available CompactFlash cards (CF cards) serve as the removable media, and are available as optional accessories. Up to 2 GB CF card supported.



Media FIFO Function

This function ensures that the CF card always retains the latest data when files are saved to it automatically. When the CF card is full, the oldest files are deleted to make room for the newest files. The media FIFO function allows you to use the DX continuously for long periods of time without having to change the CF card.

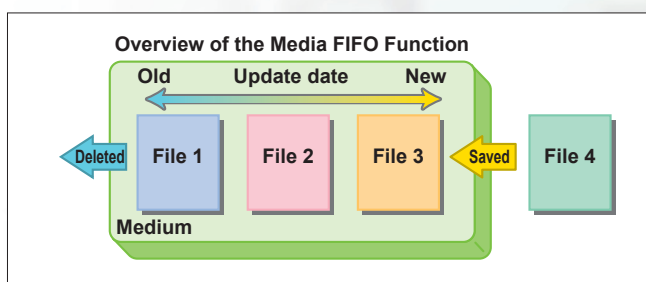

Optional USB Flash Drive

A USB flash drive can be used to transfer data to your PC. The optional front panel USB port also allows an external PC keyboard to be used with the DXAdvanced to facilitate setting and text entry.



Calibration correction schedule control function



This function provides control of the input value correction schedule. Following a predetermined schedule, DXAdvanced displays a message prompting the user to perform input value correction. This is convenient, for example, in Nadcap* related heat treatment applications.

*Nadcap: National Aerospace and Defense Contractors Accreditation Program

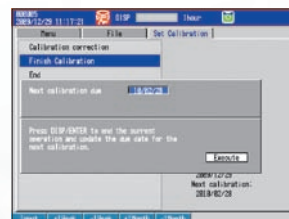

Calibration schedule setting

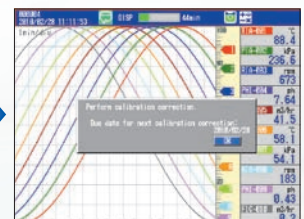

Message to prompt calibration

Excel report template function



Reports can be created automatically using a spreadsheet template created in Excel. Reports are created in Excel format, greatly reducing time and effort spent on making spreadsheets.

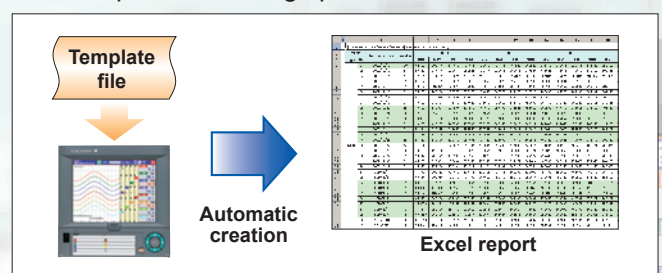

Display & Operation – New display modes and fast, easy-to-use data search functions

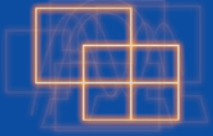

Build custom display screens that provide a new level of flexible and informative data presentation. Operators benefit from new calendar history search functions.

Customizable Display Screens! –Custom Display Function–

Freely arrange elements of trends, bar graphs, and other screen components. You can also add bitmap images to make your overview monitors more intuitive. Offers new display functions that go beyond conventional recorders.

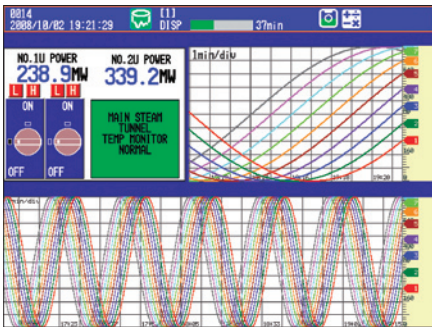

Example: Concurrent placement of screens with different time axes. Long-duration trends and nearby high-speed monitor displayed simultaneously.

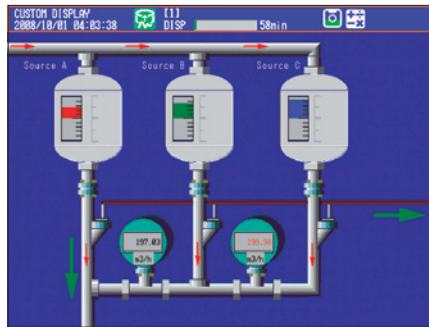

Create more intuitive overview monitors by adding bitmaps.

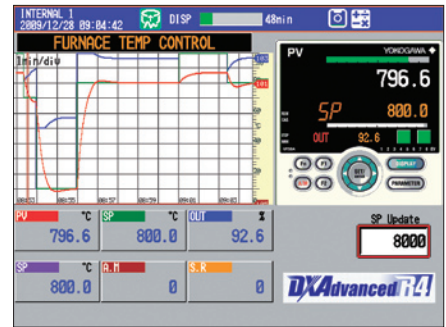

By using faceplate screens of controllers and other devices, you can design intuitive screens to fit your application.

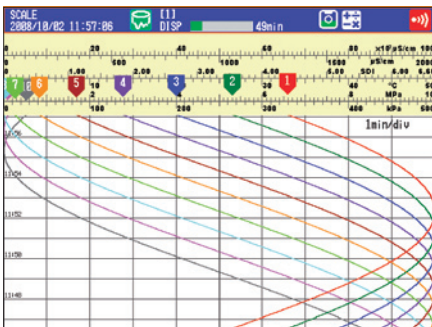

For example, you can customize a scale with an informative bitmap.

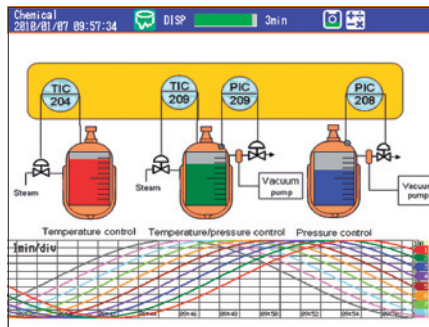

Ex. Display customized for an application

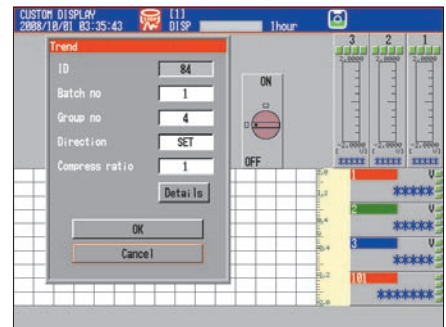

Add any of the DXAdvanced components.

DAQStudio

Builder software lets you edit and create custom display screens on a PC. You can send and receive layout data, and easily edit and create objects. * DAQStudio sold separately.

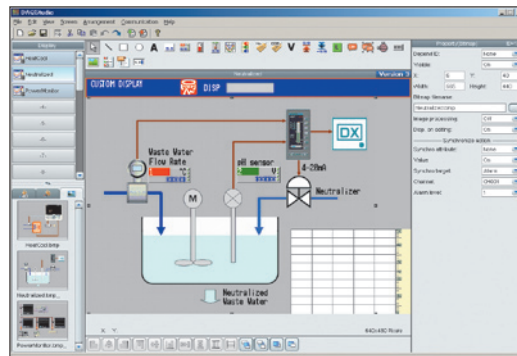
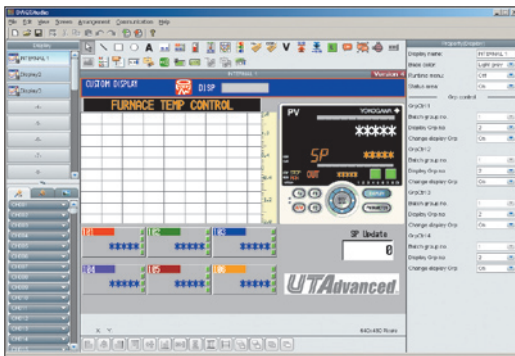

You can easily drag bitmaps and other images from a list onto your screens.

Advanced Display and User Interface

Flexible and Intuitive Display Modes

All operation screens can be accessed using the operation keys.

In addition, the Favorite key enables instant access to an operation screen that is selected in advance.

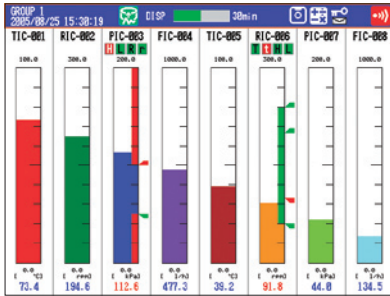

– Bar graph display –
Vertical or Horizontal bar graph can be selected in the bar graph display mode.

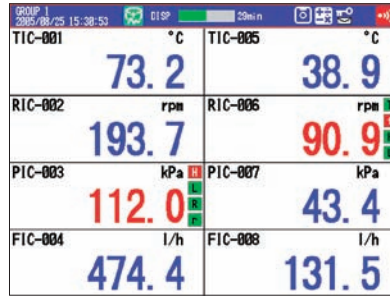

– Large-font digital display –
The digital display mode shows measured data as numeric values, and displays channel number, tag name, engineering units, and alarm status.

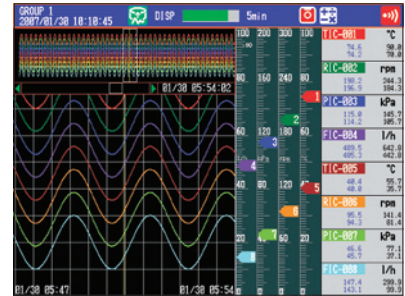

– Historical trend display –
This display mode allows you to display historical data stored in memory.

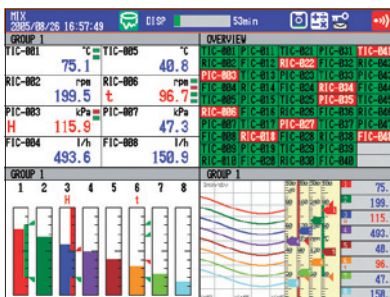

– Split screen display –
This mode lets you split the screen into four areas, and select the display format for each of the areas.

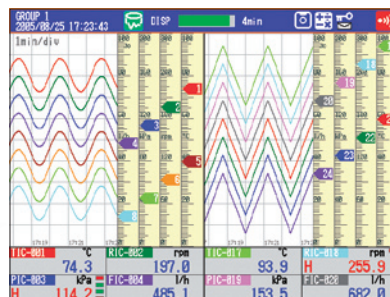

– Horizontally divided trend display –
Horizontally divides the trend display into two screens enabling waveform comparison of different channels.

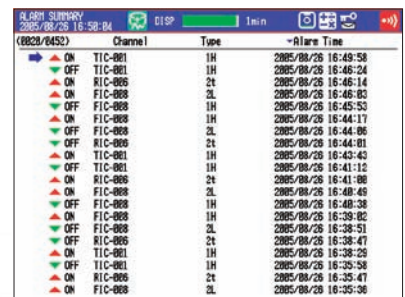

– Information display –
This information screen displays alarm summary, message summary, memory information or media information.

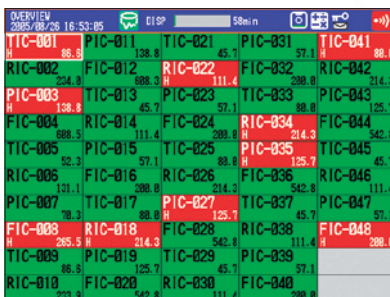

– Overview display –
This screen lets you monitor the alarm status and numeric value for all channels.

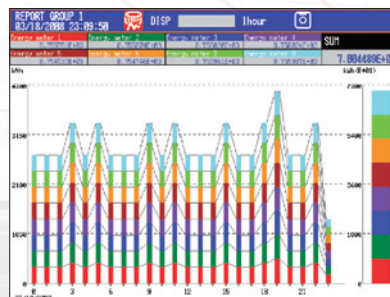

– Integral bar graph –
When connecting to a flowmeter or power monitor, you can use bar graphs to check integrated values.

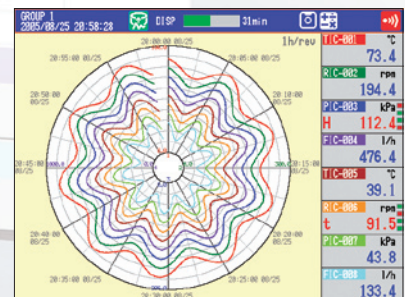

– Circular display –
In addition to the normal T-Y trend display, circular display is possible (DX2000 only).

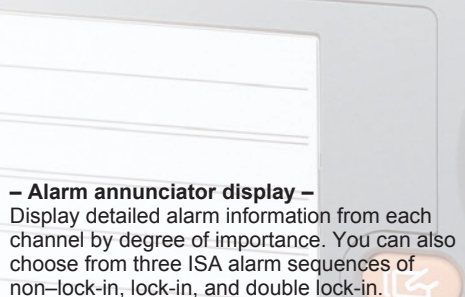

– Alarm annunciator display –
Display detailed alarm information from each channel by degree of importance. You can also choose from three ISA alarm sequences of non-lock-in, lock-in, and double lock-in.

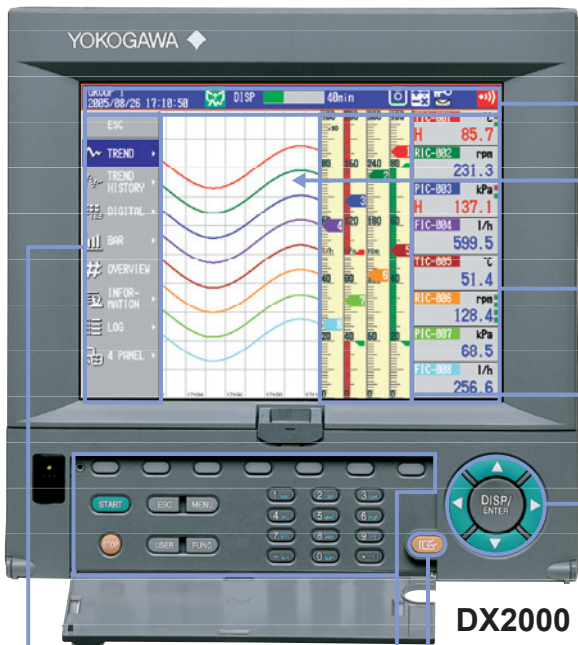

DX2000

DXAdvanced status display area

This area graphically presents the DXAdvanced operating status.

Trend display area

This area displays Trend Lines, together with scale values and engineering units for each channel along with user selectable messages.

Digital display area

This area displays digital measurement values, together with channel or tag numbers, industrial units, and alarm statuses for each channel.

Scale display area

Scales the measured values of each channel. Color band, alarm mark, or bar graph can be displayed on the scale display.

Navigation keys

The Navigation keys are used for functions such as switching display modes, primarily during normal operations (in operation mode). When entering settings, the Navigation keys are used to move the cursor.

Favorite key

Press the Favorite key to instantly switch to the display mode selected in advance.

Key panel

The key panel contains function keys, memory sampling START/STOP keys, and a numerical key pad (DX2000 only). These keys are primarily used to perform various actions related to data recording, and to enter settings in the DXAdvanced.

Display mode menu

Press the DISP key in the operation keys to show a pop-up display mode menu. Then, simply select a menu using the operation keys to switch the display mode.



DX1000

Powerful New Data Search Tool !

Search for historical data by date and time using the intuitive calendar display.

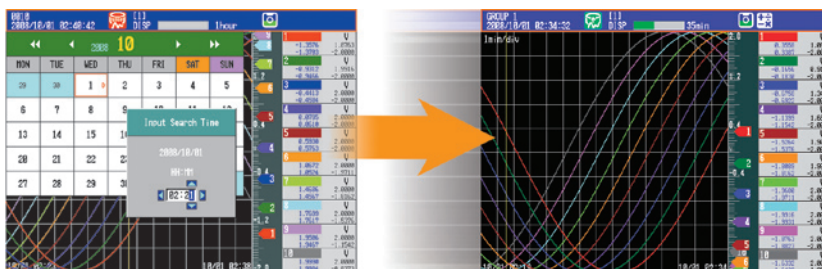

Networking – Includes the latest networking technology



Provides field data to the office or other connected devices in real time. Supports more highly advanced Web functions and network protocols such as PROFIBUS-DP and EtherNet/IP.

Web Server Functions

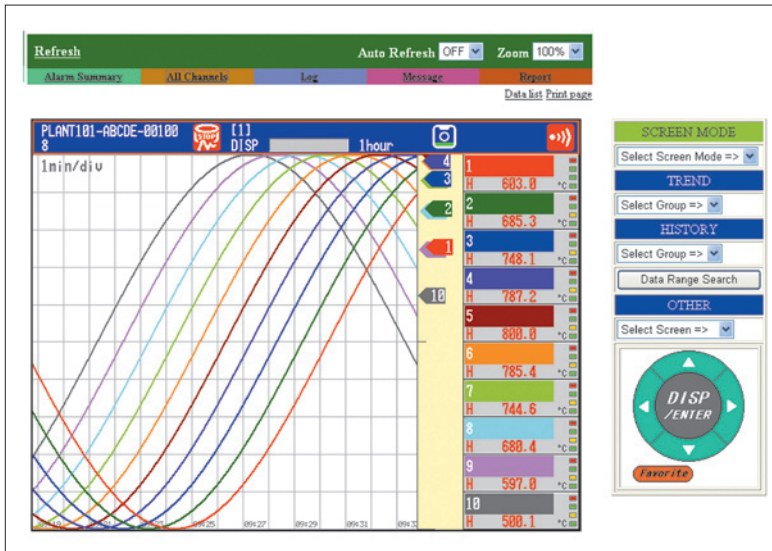

Easy monitoring from a Web browser

DXAdvanced's Web server function provides easy monitoring via Internet Explorer or other Web browsers. Offers a very easy and low-cost remote/broadband monitoring system.

Web alarm output function **R4**

You can output an audible alarm on the Web monitor (PC) when an alarm occurs.



Input messages

Input text messages to the DXAdvanced with a web browser.

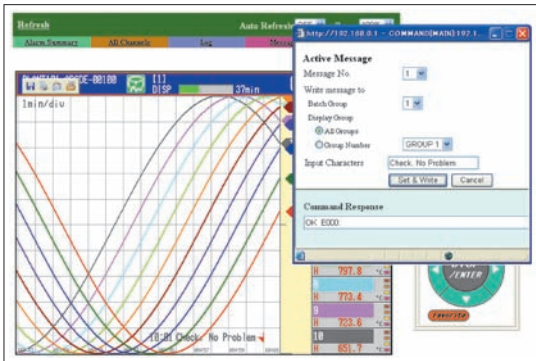

Search for data by date and time

Easily search for and browse data stored in DXAdvanced by date/time over the Web.

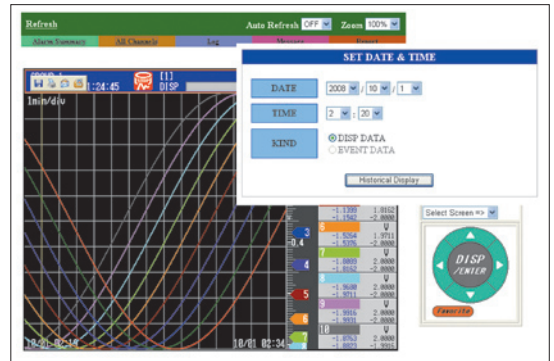

Display reports

Using the Report function on DXAdvanced, you can display selected report channels and print reports in any format from a Web browser.

UNIT	CH1	CH2	CH3	CH4	CH5	CH6	CH7	CH8	CH9	CH10
2008/10/01 09:40:14	218.4	314.8	420.9	523.6	617.8	697.2	756.4	791.2	799.4	789.4
2008/10/01 09:40:14	581.4	483.2	379.1	276.4	182.2	80.8	43.6	8.8	0.6	13.4
2008/10/01 09:40:14	218.4	314.8	420.9	523.6	617.8	697.2	756.4	791.2	799.4	789.4
2008/10/01 09:40:14	581.4	483.2	379.1	276.4	182.2	80.8	43.6	8.8	0.6	13.4
2008/10/01 09:40:14	218.4	314.8	420.9	523.6	617.8	697.2	756.4	791.2	799.4	789.4
2008/10/01 09:40:14	581.4	483.2	379.1	276.4	182.2	80.8	43.6	8.8	0.6	13.4
2008/10/01 09:40:14	218.4	314.8	420.9	523.6	617.8	697.2	756.4	791.2	799.4	789.4
2008/10/01 09:40:14	581.4	483.2	379.1	276.4	182.2	80.8	43.6	8.8	0.6	13.4

Display alarm summary

You can confirm alarm information on DXAdvanced from a Web browser.

Alarm Summary	Channel	Type	Alarm Time
OFF	10	11E	2008/10/02 09:39:53
OFF	2	33E	2008/10/02 09:39:23
OFF	9	33E	2008/10/02 09:39:17
ON	1	11E	2008/10/02 09:38:46
ON	3	33E	2008/10/02 09:38:23
OFF	10	11E	2008/10/02 09:38:17
ON	10	33E	2008/10/02 09:37:48
ON	10	11E	2008/10/02 09:37:48
ON	9	33E	2008/10/02 09:37:48
ON	9	11E	2008/10/02 09:37:48
ON	8	33E	2008/10/02 09:37:48

Display lists of data

Files saved to the removable media or internal memory can be viewed and copied.

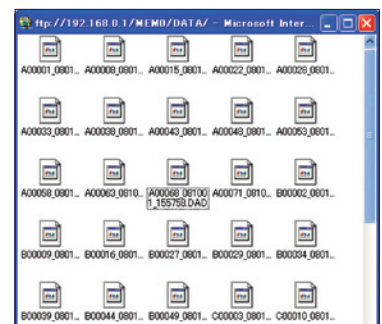

Networking Functions

[FTP data transfer]

The FTP client function in the DXAdvanced will automatically transfer, at preset times, data files saved to the DXAdvanced unit's internal memory. Both a primary and secondary server can be specified. If a transfer to the primary server fails, files will automatically be transferred to the secondary server.

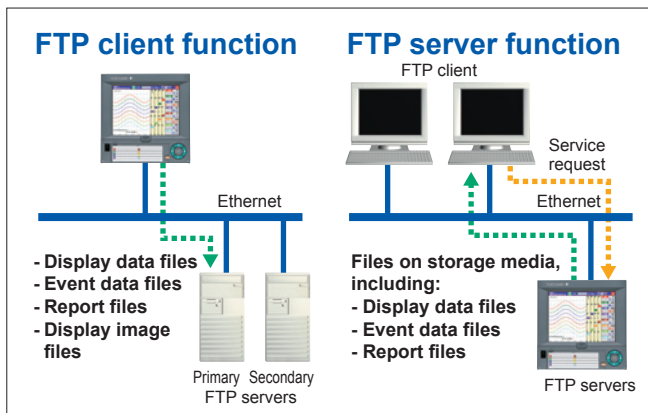

[Automatic network setup (DHCP) function]

Using Dynamic Host Configuration Protocol (DHCP), the DXAdvanced can automatically acquire the settings it needs (IP address) for network communications from a DHCP server. This makes it easier than ever to install the unit on a plant network.

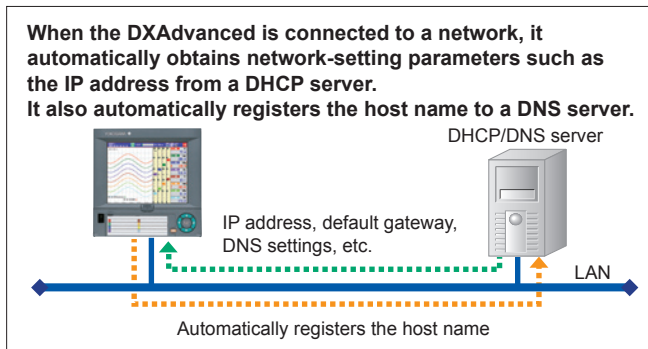

[Time synchronization with network time servers]

DXAdvanced uses SNTP protocol in client mode to acquire time information from a network time-server. This function allows any number of DXAdvanced units within a facility to have precisely synchronized time; all units will record data with coordinated date and time stamp information. In addition, DXAdvanced can function as a server, providing time data to other SNTP client units on the network.

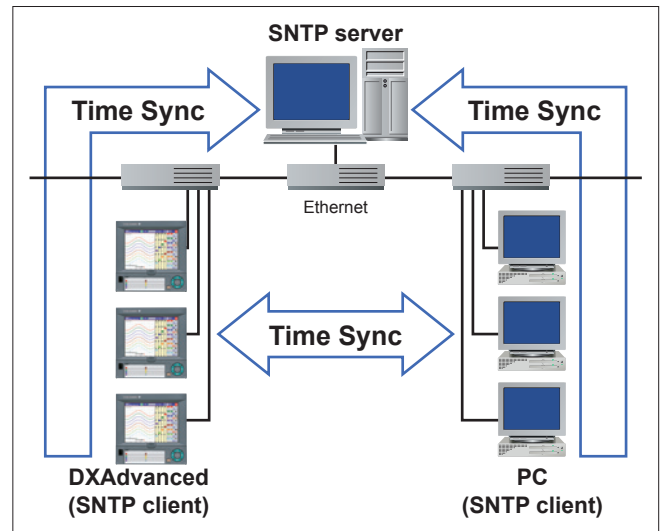

[E-mail messaging function]

The DXAdvanced can send a variety of informative e-mail messages that include alarm notification reports, periodic instantaneous data values, scheduled report data and other information.

With Internet access, DXAdvanced can send e-mail messages anywhere in the world. An e-mail-capable cellular phone can be used to receive instantaneous remote notification of alarms. Also, a POP before SMTP function and SMTP authentication are included for user authentication when sending e-mail.

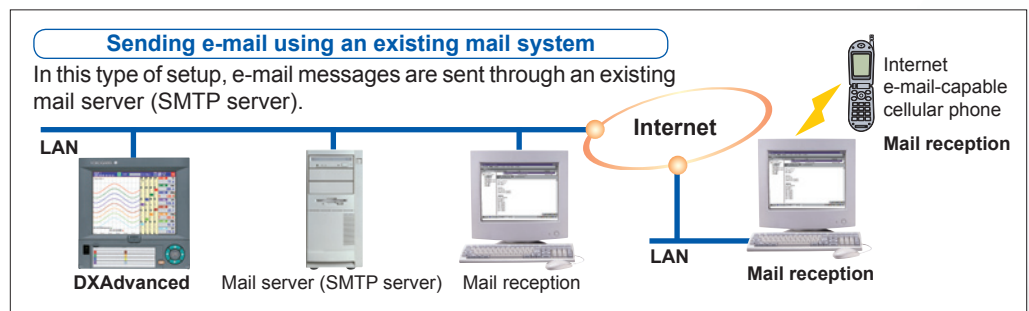

PROFIBUS-DP and EtherNet/IP Functions

DXAdvanced supports the PROFIBUS-DP slave and EtherNet/IP server functions. You can load or write measured data from DXAdvanced using a PLC or other master (client) device.

* The PROFIBUS-DP function is optional

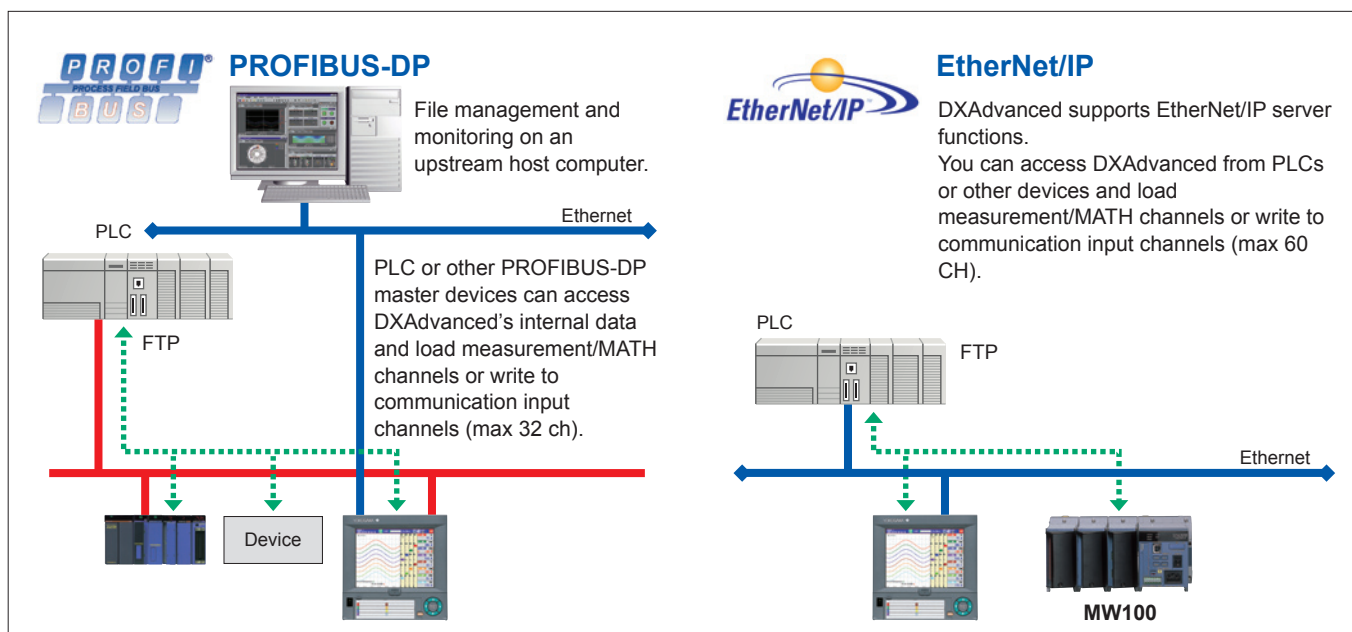

[Modbus TCP] and [Modbus RTU] Communications

DXAdvanced supports MODBUS TCP/IP client and server modes for Ethernet communications and MODBUS RTU master and slave modes for optional serial communications. Both allow large amounts of external data points to be input to and processed by the DXAdvanced from external hardware such as Yokogawa's MW100. With this capability, a multi-point data acquisition system of up to 348 channels can be configured*. This bi-directional communication also allows the DXAdvanced to provide data to other devices such as a PLC.

* External input option and mathematical functions option are required.

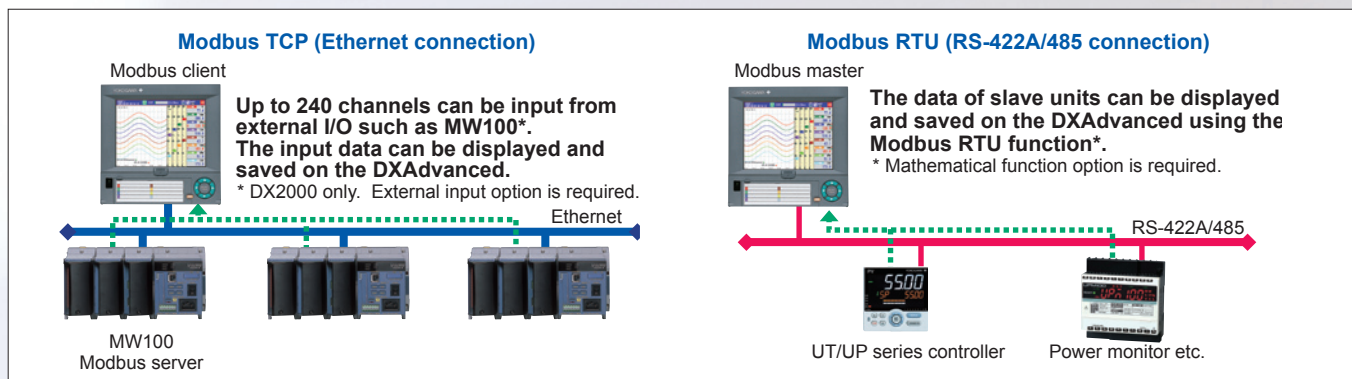

Reliability and Security – Proven Yokogawa measurement and recording technology



Designed for continuous operation where failure is not an option, the no-compromise reliability of DXAdvanced protects vital plant data.

High Level Security Functions

[Secure, binary data file format]

Measured data is saved in a proprietary, binary file format that is resistant to tampering with common software applications. The viewer software generates a message to warn the user if the data file is damaged or modified in any way.

ASCII data display

```

2000**m** -0.002, 0.005, -0.071, 0.001, -0.000,
2200**m** -0.170, -0.007, -0.175, -0.071, -0.000,
2400**m** -0.222, -0.170, -0.235, -0.175, -0.000,
2600**m** -0.371, -0.272, -0.375, -0.275, -0.000,
2800**m** -0.464, -0.271, -0.468, -0.275, -0.000,
3000**m** -0.554, -0.464, -0.554, -0.468, -0.000,
3200**m** -0.643, -0.554, -0.639, -0.554, -0.000,
3400**m** -0.719, -0.643, -0.722, -0.639, -0.000,
3600**m** -0.793, -0.719, -0.797, -0.722, -0.000,
3800**m** -0.859, -0.793, -0.859, -0.797, -0.000,
4000**m** -0.909, -0.859, -0.919, -0.859, -0.000,
4200**m** -0.946, -0.915, -0.948, -0.919, -0.000,
4400**m** -1.000, -0.946, -1.000, -0.948, -0.000,
4600**m** -1.001, -1.000, -1.003, -1.000, -0.000,
4800**m** -1.001, -1.001, -1.003, -1.003, -0.000,
5000**m** -1.072, -1.001, -1.072, -1.003, -0.000,
5200**m** -1.078, -1.073, -1.078, -1.073, -0.000,
5400**m** -1.072, -1.062, -1.076, -1.065, -0.000,
5600**m** -1.062, -1.059, -1.065, -1.058, -0.000,
5800**m** -1.059, -1.051, -1.058, -1.052, -0.000,
6000**m** -1.051, -0.978, -1.052, -0.968, -0.000,
6200**m** -0.978, -0.929, -0.968, -0.929, -0.000,
6400**m** -0.929, -0.874, -0.929, -0.874, -0.000,
6600**m** -0.874, -0.824, -0.874, -0.824, -0.000,
6800**m** -0.824, -0.774, -0.824, -0.774, -0.000,
7000**m** -0.774, -0.724, -0.774, -0.724, -0.000,
7200**m** -0.724, -0.674, -0.724, -0.674, -0.000,
7400**m** -0.674, -0.624, -0.674, -0.624, -0.000,
7600**m** -0.624, -0.574, -0.624, -0.574, -0.000,
7800**m** -0.574, -0.524, -0.574, -0.524, -0.000,
8000**m** -0.524, -0.474, -0.524, -0.474, -0.000,
8200**m** -0.474, -0.424, -0.474, -0.424, -0.000,
8400**m** -0.424, -0.374, -0.424, -0.374, -0.000,
8600**m** -0.374, -0.324, -0.374, -0.324, -0.000,
8800**m** -0.324, -0.274, -0.324, -0.274, -0.000,
9000**m** -0.274, -0.224, -0.274, -0.224, -0.000,
9200**m** -0.224, -0.174, -0.224, -0.174, -0.000,
9400**m** -0.174, -0.124, -0.174, -0.124, -0.000,
9600**m** -0.124, -0.074, -0.124, -0.074, -0.000,
9800**m** -0.074, -0.024, -0.074, -0.024, -0.000,
10000**m** -0.024, -0.000, -0.024, -0.000, -0.000,
    
```

Binary data display

[Key lock function]

A password-protected key lock can be applied to each operation key or for access to the external storage media.

[Highly reliable internal flash memory]

Reliable, non-volatile flash memory is used for internal data storage operations with ECC* function. DXAdvanced retains important data during power failures of any duration with no battery protection circuit needed.

* ECC: Error Check and Correct

[Data redundancy]

Measured and calculated data is continuously saved to secure, internal non-volatile flash memory. At manual or scheduled intervals, the files in memory are copied to the removable media, which is also secure flash memory. In addition, the files can be copied and archived to an FTP server. Because of the inherent reliability and security of flash memory and the storage methods used, the possibility of losing data under any operating condition or power failure event is extremely small. When FTP transfer functions are used, three copies of the same data file can exist at the same time in three locations, thus providing a high level of redundancy.

[Part 11 compliance]



With the advanced security function option, DXAdvanced supports the USA FDA's Title 21 CFR Part 11 regulation. This lets you use a login function for requiring user names, IDs, and passwords, plus electronic signatures, audit trails, and other security features.

Electronic signature display

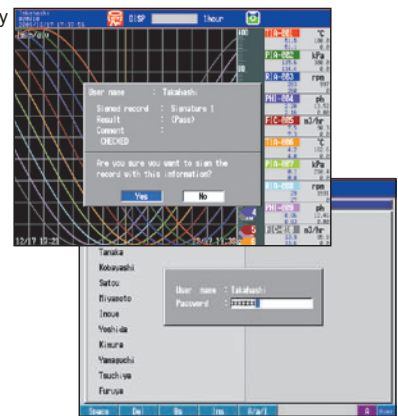

Controlled system access

[Front door lock]

A mechanical lock with removable key is provided to securely latch the front panel door. This forbids access to the power switch and removable media.

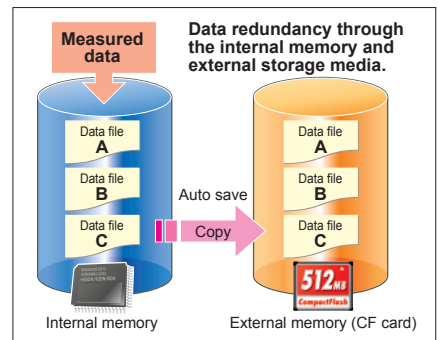
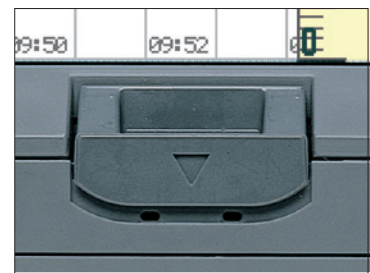

When FTP transfer functions are used, three copies of the same data file can exist at the same time in three locations, thus providing a high level of redundancy.

Robust Hardware

[Dust-proof and water-proof front panel (IEC529-IP65, NEMA No.250 TYPE4* compliant)]

Yokogawa designed the DXAdvanced to be used under harsh environmental conditions. The front panel has a dust-proof, water-proof design which is compliant with the IEC529-IP65 and NEMA No.250 TYPE4* standard. This structure provides good protection for the recorder's internal components as well as the removable storage media drive mechanism.



*Except external icing test.

[High-breakdown-voltage solid-state relays]

DXAdvanced uses high-breakdown-voltage solid-state relays as scanners for switching input signals. These relays consist of MOSFETs capable of withstanding high voltage (1500 V DC) with low leakage current (3 nA), and power-output photocouplers. They provide high-speed scanning (125 ms/48 channels in the DX2048) while increasing scanner life and eliminating noise.

[Isolated channel inputs]

DC voltage and thermocouple inputs in all DXAdvanced models are channel-isolated. (Channel isolation for RTD inputs is optional on some models.) The high common mode noise characteristic enabled by isolated channel inputs ensures stable measurements in a wide range of applications.

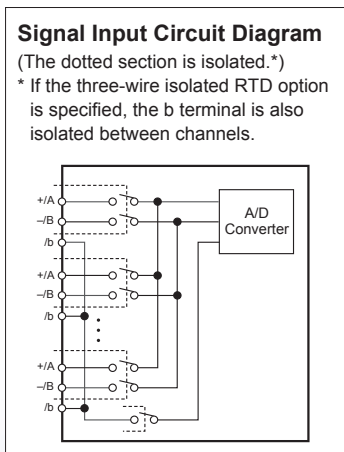

[4 mm removable screw input terminals]

Input terminals are the "entryways" through which all measurements enter a recorder. A reliable mechanical connection to the field wiring is critical for stable data collection. Rugged 4 mm screw input terminals are used on all DXAdvanced models. Input terminals can also be removed with the wiring attached to facilitate installation and maintenance.



DX1000



DX2000

[Removable clamp input terminal]

The removable clamp input terminal is available with the option (/H2). As this terminal is removable, it makes it very easy to change sensors such as thermocouples frequently.



[Compliance with safety standards and EMC standards]

Another indication of the reliability of DXAdvanced is their compliance with the stringent specifications for international safety and electromagnetic compatibility (EMC) standards. Of course, DXAdvanced have also been approved for the CE standards.



Yokogawa EMC laboratory

- CSA: CSA22.2 No61010-1, installation category II, pollution degree 2
- UL: UL61010-1 (CSA NRTL/C)
- CE: EMC directive: EN61326 compliance (Emission: Class A, Immunity: Annex A)
 - EN61000-3-2 compliant
 - EN61000-3-3 compliant
 - EN55011 compliant, Class A Group 1
- Low voltage directive: EN61010-1 compliant, measurement category II, pollution degree 2
- C-Tick: AS/NZS CISPR11 compliant, Class A Group 1

Application Software –For data management



Configure settings and review historical data with a PC. Choose optional software for data acquisition, reporting, and other applications.

DAQSTANDARD

DAQSTANDARD is a standard software package included with the DXAdvanced. It can be used to print or redisplay historical data files saved by the DXAdvanced unit or transferred through FTP.

[Data viewer & Hardware configurator]

The Data Viewer module can be used to display and print data in files generated by the DXAdvanced unit. Data can be viewed in trend displays, digital displays, circular displays, and lists. In addition, the cursor can be used to read numerical values in displayed data, or to make interval calculations. You can add electronic signatures to data (only for advanced security function option (/AS1)). Data can be converted to ASCII, or to file formats that can be opened in Excel or Lotus 1-2-3. All DXAdvanced configuration settings can be modified on-line via the network connection using the hardware configurator tool.

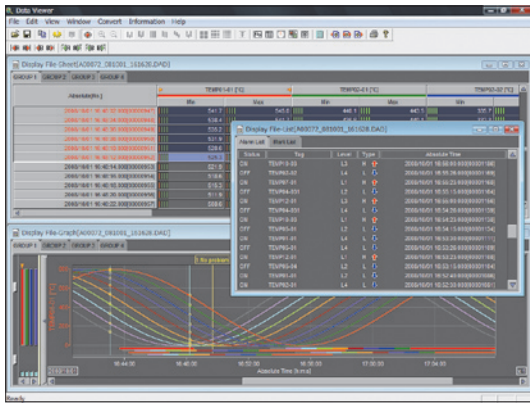

Data Viewer

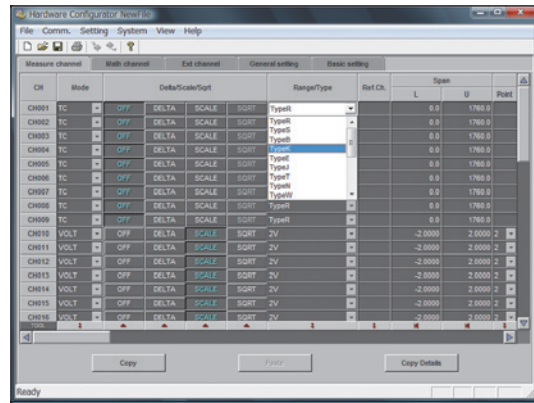

Measurement channel setting

DAQManager

DAQManager is a data management program that gives you powerful tools for daily tasks. You can perform targeted searches of data saved by DXAdvanced, superimpose the resultant data on the display for comparisons, and print the data.

* DAQManager does not support models with the advanced security function option (/AS1).

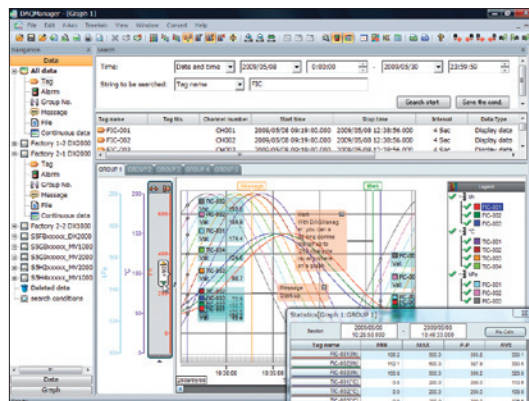

DAQWORX



DAQWORX is a data acquisition software suite that integrates Yokogawa recorders, data acquisition instruments, and measurement instruments.
 * Support for DXAdvanced R4 (release 4) will be scheduled in June, 2010.

[DAQLOGGER]



A data logging software application that enables Ethernet and serial communication to be used simultaneously. A mixture of DXAdvanceds, DARWIN data acquisition units, and uR recorders can be combined (32 units total) to achieve data acquisition of 1600 channels.

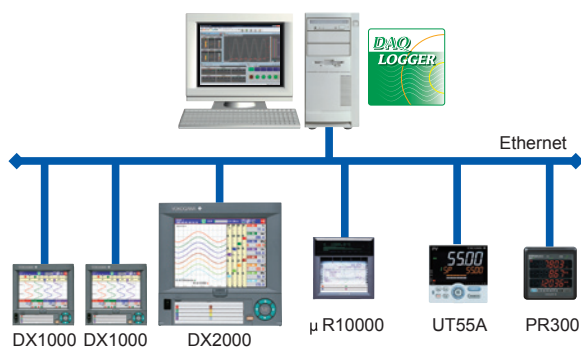

Certain models require Gate software programs (drivers) separately, and connect only up to 16 units with Gate software connection.

* When registering users on models with the advanced security function option (/AS1), certain limitations apply to control commands and other aspects of serial communication.

[DAQEXPLORER]

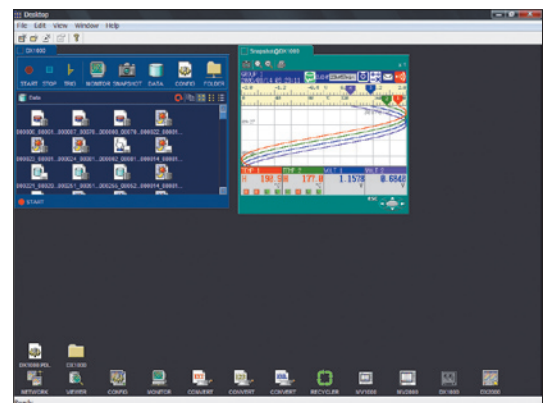

DAQEXPLORER is a dedicated software program for the DX, CX, and MV that offers a combination of file transmission, PC-based monitoring, and other functions in addition to the DAQSTANDARD functions. It provides easy access to the wide array of DXAdvanced networking functions.

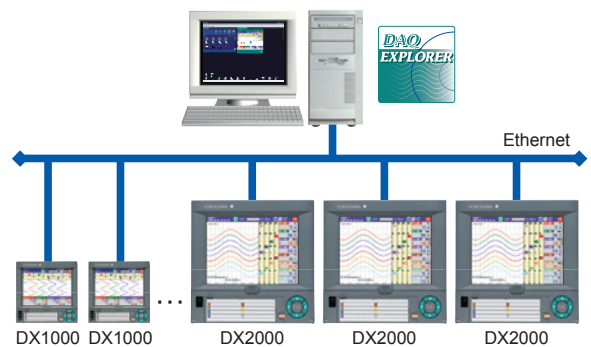

* DAQEXPLORER does not support models with the advanced security function option (/AS1).

SPECIFICATIONS

See the general specifications (GS 04L41B01-01E, 04L42B01-01E) for the detailed specification

STANDARD SPECIFICATIONS

General Specifications

Construction

Mounting: Flush panel mounting (on a vertical plane)
Mounting may be inclined downward up to 30 degrees from a horizontal plane.

Allowable Panel Thickness: 2 to 26 mm

Front Panel: Water and dust-proof
(based on IEC529-IP65 and NEMA No.250 TYPE4*)

Input

Number of Inputs:
DX1000: 2, 4, 6, 12 channels
DX2000: 4, 8, 10, 20, 30, 40, 48 channels

Measurement Interval:
DX1002, DX1004, DX2004, DX2008:
125 ms, 250 ms, 25 ms (fast sampling mode*)
DX1006, DX1012, DX2010, DX2020, DX2030, DX2040, DX2048:
1 s (Not available when A/D integration time is set to 100 ms), 2 s, 5 s, 125 ms (fast sampling mode*)
* A/D integration time is fixed to 1.67 ms in case of fast sampling mode.

Inputs: DCV (20, 60, 200 mV, 2, 6, 20, 50 V, 1-5 V)
TC (R, S, B, K, E, J, T, N, W, L, U, WRε)
RTD (Pt100, JPt100)
DI (Contact input, TTL level)
DCA (With external shunt resistor attached)

Input	Range	Measurement accuracy (when the integration time is 16.7 ms or more)	Display resolution
DCV	1-5 V	±(0.05% of rdg+3 digits)	1 mV
Thermocouple*	K	±(0.15% of rdg+0.7°C)	0.1°C
Resistance thermometer detector	Pt100	±(0.15% of rdg+0.3°C)	0.1°C

* Does not include the accuracy of reference junction compensation

Display

Display unit:
DX1000: 5.7-inch TFT color LCD (320 x 240 pixels)
DX2000: 10.4-inch TFT color LCD (640 x 480 pixels)

Display group:
Number of display: DX1000: 10 groups, DX2000: 36 groups
Number of assignable channels for one group:
DX1000: 6 channels, DX2000: 10 channels

Display color:
Trend/Bargraph: Selectable from 24 colors
Background: White or black selectable
Trend display:
Trend display type: Vertical, horizontal, landscape, horizontal split or circular* selectable
* Circular display is only for DX2000.

Bargraph display:
Direction: Vertical or horizontal selectable

Digital indication:
Display renewal rate: 1 s

Overview display:
Number of indication channels:
Measuring values and alarm status of all channels

Information display:
Alarm summary, message summary, memory information, report information, relay status, Modbus status

Tag display:
Tag number and comment display
No. of displayable characters
Tag no.: 16 max
Tag comment: 32 max

Displayable characters:
Tag no.: Alphanumerics
Tag comments: Alphanumerics, Japanese, and Chinese

Messages:
Number of characters: 32 characters maximum
Number of messages: 100 messages (including 10 free messages)

Data referencing function: Display the retrieved data (display data or event data) from internal or external memory.

Custom display function:
User can change display object (trend, numeric, and bar graphs, etc.) sizes and attributes, and add objects freely to create screens.
No. of screens: 28 (3 from internal memory, 25 from external media (CF))
Max no. of placeable display objects:
134 (normal: 80, scale: 4, trend: 4, list: 4, graphic: 40, bitmap: 2)

Data Saving Function
External storage medium:
Medium: CompactFlash memory card (CF card)
Internal memory:
Medium: Flash memory

Capacity: 400MB
Maximum number of files can be saved:
400 files
(total number of display data file and event data file)

Alarm Function

Number of alarm levels: Up to four levels for each channel
Alarm types: High and low limits, differential high and low limits, high and low rate-of-change limits and delay high and low

Alarm annunciator function:
Alarm display based on alarm sequence, and relay output operation.
Supported alarm sequences: 3 (ISA-A-4, ISA-A, ISA-M)

Event action function
General: Particular action can be executed by particular event.
Number of event action: 40 actions can be set

Security functions *
General: Login function or key lock function can be set for each key operation or communication operation.
Key lock function: On/off and password can be set for each operation key and FUNC operation.
Login function: User name and password to login can be set.
* Please refer the Advanced security function option (/AS1) for the models with the /AS1 option.

Clock

Clock: With calendar function (year of grace)
Clock accuracy: ±10 ppm, excluding a delay (of 1 second, maximum) caused each time the power is turned on.
DST function (summer/winter time):
The time at which the daylight savings time adjustment is automatically calculated and configured.

Communication Functions

Connection: Ethernet (10BASE-T)
Protocols: TCP, UDP, IP, ICMP, ARP, DHCP, HTTP, FTP, SMTP, SNTP, Modbus, DX private

E-mail inform function:
FTP client function:
Transferred data file, FTP server function, Web server function, SNTP client function, SNTP server function, DHCP client function, Modbus client function, Modbus server function

EtherNet/IP server
Connects to EtherNet/IP networks as an Adapter (Server).

Batch function
General: Data display and data management with batch name, text field function and batch comment function are available.

Power Supply
Rated power supply: 100 to 240 VAC (automatic switching)
Allowable power supply voltage range:
90 to 132 or 180 to 264 VAC
Rated power supply frequency:
50/60 Hz (automatic switching)

Power consumption:
DX1000: 60 VA (max., for 240 VAC power supply)
DX2000: 100 VA (max., for 240 VAC power supply)

Normal Operating Conditions

Power voltage: 90 to 132 or 180 to 250 VAC
Power supply frequency: 50 Hz ±2%, 60 Hz ±2%
Ambient temperature: 0 to 50 °C
Ambient humidity: 20% to 80% RH (at 5 to 40 °C)

SPECIFICATIONS OF OPTIONAL FUNCTIONS

Alarm Output Relays (/A1, /A2, /A3, /A4*, /A5*)
An alarm signal is output from the rear panel as a relay contact signal.
Number or output: Select from 2, 4, 6, 12* and 24* points
* Only for DX2000.

Serial Communication Interface (/C2, /C3)
Connection: EIA RS-232 (/C2) or RS-422A/485 (/C3)
Protocols: DX private protocol, Modbus(master/slave) protocol
Setting/measurement server function:
Operation, setting or output of measurement data are available by DX private protocol.

Modbus communication: Reading or writing of measurement data on other instruments are available by Modbus protocol.*
* /M1 option or /MC1 option is required to read data from other instrument.

VGA Video Output (/D5)
Resolution: 640 x 480 pixels (VGA)

Fail/Status Output (/F1)
The relay contact output on the rear panel indicates the occurrence of CPU failure or selected status.

- Fail & Alarm Output Relays 22 points (/F2, only for DX2000)
Combination of "Fail/Status output function" and "Alarm output relays 22 points".
- Clamped Input Terminal (/H2)
Clamped input terminal (detachable type) is used for input terminal.
- Desk Top Type (/H5 [], /H5*)
Provides carrying handle and power cord.
* /H5 is only for 24 VDC/AC power supply model (/P1), and does not include power code.
- Mathematical Functions (/M1)
Used for calculating data, displaying trends and digital values, and recording calculated data assigned to channels.
Channel assignable to calculated data:
DX1002, DX1004: 12 channels, DX1006, DX1012: 24 channels
DX2004, DX2008: Up to 12 channels
DX2010, DX2020, DX2030, DX2040, DX2048: 60 channels
Operation:
General arithmetic operations, Statistical operations, Special operations, Conditional operation
Constant: Up to 60 constants (K01 to K60)
Report functions:
Report type: Hourly, daily, hourly + daily, daily + weekly and daily + monthly
Operation: Max. 4 types are selectable from average, maximum, minimum, instantaneous and summation
- Cu10, Cu25 RTD Input /3 leg isolated RTD Input (/N1)
This option allows Cu10 and Cu25 inputs to be added to the standard input types.
- 3 legs Isolated RTD Input (/N2*)
A, B, b legs are of isolated input type.
* Only for DX1006, DX1012, DX2010, DX2020, DX2030, DX2040 and DX2048.
- Extended Input Types (/N3)
This option allows extra input types as below to be added to the standard input types.
TC: Kp vs Au7Fe, PLATINEL, PR40-20, NiNiMo, W/Wre26, TypeN (AWG14)
RTD: Pt25, Pt50, Ni100 (SAMA), Ni100 (DIN), Ni120, J263*B, Cu53, Cu100, Pt46, Pt200
- 24 VDC/AC Power Supply (/P1)
Rated power supply: 24 VDC or 24 VAC (50/60Hz)
Allowable power supply voltage range:
21.6 to 26.4 VDC/AC
Max. power consumption:
DX1000: 28 VA (24 VDC), 45 VA (24 VAC (50/60 Hz))
DX2000: 45 VA (24 VDC), 70 VA (24 VAC (50/60 Hz))
- Remote Control (/R1)
This option allows eight functions to be controlled remotely by a contact input.
- 24 VDC transmitter power supply (/TPS2*, /TPS4, /TPS8*)
Output voltage: 22.8 to 25.2 VDC (rated load current)
Rated output current: 4 to 20 mA DC
* /TPS2 is only for DX1000, /TPS8 is only for DX2000
- Easy text entry (/KB1, /KB2)
Remote control terminal is available to operate the DX.
Number of units that can be controlled:
Max. 32 units by ID setting
- USB interface (/USB1)
USB interface specification: Based on Rev1.1, host function
Number of ports: 2 ports (Front and rear panel)
Available USB devices:
Keyboard: 104/89 keyboard (US) based on USB HID Class Ver.1.1
External medium: USB flash drive (Some of the USB flash drive may not be supported by DXAdvanced.)
- Pulse input (/PM1)
Pulse input option includes mathematical functions option (/M1) and remote control option (/R1).
Number of inputs: 3 points (8 points are available in case of using remote inputs)
Input format: Photocoupler isolation (shared common)
Isolated power supply for input terminal (approx. 5 V)
- Calibration correction function (/CC1)
Corrects the measurement value of each channel using segment linearizer approximation.
Number of segment points: 2 to 16
- External input function (/MC1, only for DX2000)
Digital input channels via communication are extended to input data from other instruments.
Number of external input channels:
Up to 240 channels (channel number: 201 to 440)
* Only for DX2010, DX2020, DX2030, DX2040 and DX2048
* Fast sampling mode is not available when external input option is equipped.
- Multibatch function (/BT2)
User can start/stop recording independently by batch, and create data files.
No. of multibatches: DX1000: 2 to 6 (DX1006, DX1012 only)
DX2000: 2 to 12 (DX2010, DX2020, DX2030, DX2040, DX2048 only)
- PROFIBUS-DP communication interface function (/CP1)

- PROFIBUS-DP master devices can access the following internal data.
- Load measurement channel data
 - Load MATH channel data
 - Write communication input channel data
 - Node address setting range: 0 to 125
 - Interface: PROFIBUS-DP-V0 Slave
 - Transmission medium: 2 dedicated cables
 - Transmission speed/distance: 9.6 kbps/1200 m to 12 Mbps/100 m
 - Termination resistance: None (requires external termination resistance)
 - Advanced security function (/AS1)
Security and electronic record/signature functions have been added that are compliant with the USA's FDA title 21 CFR Part 11.
Data anti-tamper function: Settings and measured data are saved as encrypted binary files.
 - Login function:
Using the login function (user name, user ID and password), you can enter security settings on the instrument
 - User level and number of users:
System administrator: 5 users (all can be operated)
General user: 90 users
 - Electronic signature function:
After checking data that has finished being recorded, you can add three levels of electronic signature, select a pass/fail, and enter comments
 - Audit Trail Function:
The settings change log and the operation log when the change was made are saved.
 - Password management function:
Logins are verified by a Kerberos authentication server

Dimensions

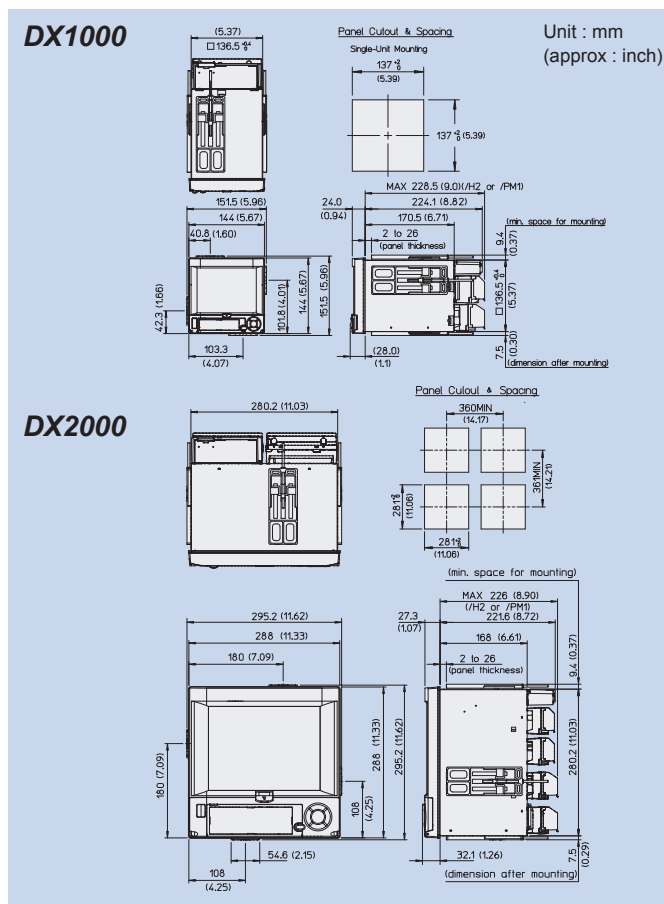

Two panel brackets are used in panel-mounting the DX1000 and DX2000. They may be used either on the left or right or top and bottom. See Yokogawa's General Specification (GS 04L41B01-01E) for information on panel cutting dimensions for DX1000 vertical or horizontal attachments. Unless otherwise indicated, tolerance is $\pm 3\%$ (or ± 0.3 mm for dimensions under 10 mm).

Daqstation and DXAdvanced are registered trademarks of Yokogawa Electric Corporation. Microsoft, MS, and Windows are registered trademarks or trademarks of Microsoft Corporation in the United States and other countries. Pentium are registered trademarks of Intel Corporation. Ethernet is a registered trademark of Xerox Corporation. Modbus is a registered trademark of AEG Schneider Automation Inc. Other company names and product names appearing in this document are registered trademarks or trademarks of their respective holders. PROFIBUS-DP is a registered trademark of PROFIBUS User Organization. EtherNet/IP is a registered trademark of ODVA (Open DeviceNet Vendor Association).

MODEL AND SUFFIX CODES

DX1000

Model code	Suffix code	Optional code	Description
DX1002			2ch, 125ms (Fast sampling mode: 25ms)
DX1004			4ch, 125ms (Fast sampling mode: 25ms)
DX1006			6ch, 1s (Fast sampling mode: 125ms)
DX1012			12ch, 1s (Fast sampling mode: 125ms)
Internal memory	-3		400MB
External media	-4		CF card (with media)
Display language	-2		English, degF, DST(summer/winter time)
Options		/A1	Alarm output 2 points *1
		/A2	Alarm output 4 points *1
		/A3	Alarm output 6 points *1 *2
		/C2	RS-232 interface *3
		/C3	RS-422-A/485 interface *3
		/F1	FAIL/Status output *2
		/H2	Clamped input terminal (detachable)
		/H5	Desktop type (for /P1 model, without power code, screw type power terminal) *4
		/H5[]	Desktop type *5
		/M1	Mathematical functions
		/N1	Cu10,Cu25 RTD input/3 leg isolated RTD
		/N2	3 leg isolated RTD *6
		/N3	Extended input type (PR40-20, Pt50, etc.)
		/P1	24VDC/AC power supply *4
		/R1	Remote control
		/TPS2	24VDC transmitter power supply (2 loops) *7
		/TPS4	24VDC transmitter power supply (4 loops) *8
		/KB1	Easy text entry (with input terminal) *9 *10
		/KB2	Easy text entry (without input terminal) *9
		/USB1	USB interface
		/PM1	Pulse input (including remote control and mathematical functions) *11
		/CC1	Calibration correction function
		/BT2	Multi-batch functions *12
		/CP1	PROFIBUS-DP functions *3
		/AS1	Advanced security functions

- *1 /A1, /A2 and /A3 cannot be specified together.
 *2 /A3 and /F1 cannot be specified together.
 *3 /C2, /C3 and /CP1 cannot be specified together.
 *4 In case that 24 VDC/AC power supply (/P1) and desktop type are specified together, /H5 must be specified. /P1 and /H5[] cannot be specified together.
 *5 /H5[]
 D: Power cord UL, CSA st'd
 F: Power cord VDE st'd
 R: Power cord SAA st'd
 J: Power cord BS st'd
 H: Power cord GB st'd
- *6 /N2 can be specified for only DX1006 and DX1012.
 *7 In case that /TPS2 is specified, /TPS4, /A2, /A3 or /F1 cannot be specified together.
 *8 In case that /TPS4 is specified, /TPS2, /A1, /A2, /A3 or /F1 cannot be specified together.
 *9 /KB1 and /KB2 cannot be specified together.
 *10 In case that /KB1 is specified, remote input terminal (438227) is included.
 *11 In case that /PM1 is specified, /A3, /M1, /R1, /TPS2 or /TPS4 cannot be specified. And combination of /A2/F1 cannot be specified together.
 *12 /BT2 can be specified for only DX1006, DX1012.

APPLICATION SOFTWARE

Model code	Description	OS
DXA120	DAQSTANDARD	Windows 2000/XP/Vista
DXA170	DAQStudio	Windows XP/Vista
DXA250	DAQManager	Windows XP/Vista

ACCESSORIES

Product	Model code (part number)	Specification
Shunt resistor (for screw input terminal)	415920	250Ω±0.1%
	415921	100Ω±0.1%
	415922	10Ω±0.1%
Shunt resistor (for clamped input terminal)	438920	250Ω±0.1%
	438921	100Ω±0.1%
	438922	10Ω±0.1%
CF card adapter	772090	-
CF card	772093	512MB
	772094	1GB
Mounting bracket	B9900BX	-
Door lock key	B8706FX	-
Remote control terminal	438227	For /KB1, /KB2 option
Validation documents	438230	For /AS1 option

DX2000

Model code	Suffix code	Optional code	Description
DX2004			4ch, 125ms(Fast sampling mode: 25ms)
DX2008			8ch, 125ms(Fast sampling mode: 25ms)
DX2010			10ch, 1s(Fast sampling mode: 125ms)
DX2020			20ch, 1s(Fast sampling mode: 125ms)
DX2030			30ch, 1s(Fast sampling mode: 125ms)
DX2040			40ch, 1s(Fast sampling mode: 125ms)
DX2048			48ch, 1s(Fast sampling mode: 125ms)
Internal memory	-3		400MB
External media	-4		CF card (with media)
Display language	-2		English, degF, DST(summer/winter time)
Options		/A1	Alarm output 2 points *1
		/A2	Alarm output 4 points *1 *12
		/A3	Alarm output 6 points *1
		/A4	Alarm output 12 points *1 *9 *12
		/A5	Alarm output 24 points *1 *2 *8 *12
		/C2	RS-232 interface *3
		/C3	RS-422-A/485 interface *3
		/D5	VGA output
		/F1	FAIL/Status output *2 *4 *9
		/F2	FAIL + Alarm output 22 points *1 *4 *8 *12
		/H2	Clamped input terminal (detachable)
		/H5	Desktop type (for /P1 model, without power code, screw type power terminal) *5
		/H5[]	Desktop type *6
		/M1	Mathematical functions *12
		/N1	Cu10,Cu25 RTD input/3 leg isolated RTD
		/N2	3 leg isolated RTD *7
		/N3	Extended input type (PR40-20, Pt50, etc.)
		/P1	24VDC/AC power supply *5
		/R1	Remote control *12
		/TPS4	24VDC transmitter power supply (4 loops) *8
		/TPS8	24VDC transmitter power supply (8 loops) *8 *9 *12
		/KB1	Easy text entry (with input terminal) *10 *11
		/KB2	Easy text entry (without input terminal) *10
		/USB1	USB interface
		/PM1	Pulse input (including remote control and mathematical functions) *12
		/CC1	Calibration correction function
		/MC1	External input function *13
		/BT2	Multi-batch functions *14
		/CP1	PROFIBUS-DP functions *3
		/AS1	Advanced security functions

- *1 /A1, /A2, /A3, /A4, /A5, and /F2 cannot be specified together.
 *2 /A5 and /F1 cannot be specified together.
 *3 /C2, /C3, and /CP1 cannot be specified together.
 *4 /F1 and /F2 cannot be specified together.
 *5 In case that 24 VDC/AC power supply (/P1) and desktop type are specified together, /H5 must be specified. /P1 and /H5[] cannot be specified together.
 *6 /H5[]
 D: Power cord UL, CSA st'd
 F: Power cord VDE st'd
 R: Power cord SAA st'd
 J: Power cord BS st'd
 H: Power cord GB st'd
- *7 /N2 can be specified only for DX2010, DX2020, DX2030, DX2040 and DX2048.
 *8 /TPS4, /TPS8, /A5 and /F2 cannot be specified together.
 *9 If /TPS8 is specified, /A4 and /F1 cannot be specified together.
 *10 /KB1 and /KB2 cannot be specified together.
 *11 If /KB1 is specified, a remote control terminal (438227) is included.
 *12 If /PM1 is specified, /A5, /F2, /M1, and /R1 cannot be specified together. The combination of /A2/F1 and the combination of /A4/TPS8 cannot be specified together.
 *13 /MC1 can be specified only for the DX2010, DX2020, DX2030, DX2040, and DX2048.
 *14 /BT2 can only be specified for the DX2010, DX2020, DX2030, DX2040, and DX2048.

RELATED PRODUCT

DXAdvanced Removable Chassis Model **DX1000N**

Removable Chassis Model featuring easy maintenance.

*This model enables you to pull the inner chassis out from the case without having to remove the power supply, communication, and input wiring on the rear panel



NOTICE

- Before operating the product, read the instruction manual thoroughly for proper and safe operation.
- If this product is for use with a system requiring safeguards that directly involve personnel safety, please contact the Yokogawa sales offices.

vigilantplant.[®]

SEE
CLEARLY

KNOW
IN ADVANCE

ACT
WITH AGLITY

The clear path to operational excellence

VigilantPlant is Yokogawa's automation concept for safe, reliable, and profitable plant operations. VigilantPlant aims to enable an ongoing state of Operational Excellence where plant personnel are watchful and attentive, well-informed, and ready to take actions that optimize plant and business performance.

YOKOGAWA ELECTRIC CORPORATION

Control Instruments Business Division/Phone: (81)-422-52-7179, Fax: (81)-422-52-6973

E-mail: ns@cs.jp.yokogawa.com

YOKOGAWA CORPORATION OF AMERICA

Phone: 800-258-2552, Fax: (1)-770-254-0928

YOKOGAWA EUROPE B.V.

Phone: (31)-88-4641000, Fax: (31)-88-4641111

YOKOGAWA ENGINEERING ASIA PTE. LTD.

Phone: (65)-62419933, Fax: (65)-62412606

Sign up for our free e-mail newsletter
www.yokogawa.com/ns/

Vig-RS-6E

Printed in Japan, 404(KP) [Ed : 07/b]

Subject to change without notice.

All Rights Reserved, Copyright © 2005, Yokogawa Electric Corporation.

YOKOGAWA