

## Product Information



### **Control 4000** Photometric Analyzers

### **Control 8000** Universal Analyzers



english  
deutsch  
español  
portuguese  
русский язык  
中文  
日本語  
français  
italiano

For over 30 years, optek has focused on measuring process liquids through their interaction with light in facilities all over the world. Although global, optek remains a family owned company with a team of more than 100 qualified, customer-driven professionals.

Our confidence is born from experience. With the expertise of more than 30,000 installations worldwide, our value to the customer resides in providing a superior product that pays back. High quality materials withstand the toughest process conditions including aggressive media, high temperature, and

high pressure applications. Cleanability is ensured using high quality wetted materials, superior design, as well as sapphire optical windows.

As a global partner to various industries, optek offers the most advanced technologies including superior signal amplification, inline calibration support, PROFIBUS® PA, FOUNDATION™ Fieldbus and multilingual user interfaces for easy onsite operations.

Our support ensures long term satisfaction with programs such as “Speed-Parts” and “SwapRepair” to provide our

customers sustainable operations and minimized downtime at the lowest cost of ownership.

Conformity to international (ISO 9001), industry-specific (FM/ATEX approval) or company standards is easily achieved with optek. Wherever process composition is controlled, the name optek has become synonymous with world-class products and support.

**Optimize your process  
with optek inline control.**



## Content

C4000 / C8000 – converters	03
C4000 – photometric converter (configurations)	04
C8000 – universal converter (configurations)	06
C4000 / C8000 – accessories	08
C4000 / C8000 – technical data	09
Optical sensors – overview	10
Optical sensors – principles	11
Turbidity sensors AF16-N / TF16-N	12
Color sensors AF16-F / AF26	14
UV sensors AF45 / AF46	16
Probe sensors AS16 / AS56	18
Probe sensors ASD12-N / ASD25-N	20
Conductivity sensor ACF60 / ACS60	22
pH electrode adapter PF12	23
Single Use Cell (S.U.C.)	24
Sensor body (armature)	26
System – calibration	27
optek – worldwide contact	28

**See our TOP 5 brochures for applications in your industry.**



## Control 4000 and Control 8000 are powerful, microprocessor-based converters.

The advanced modular design enables precision process monitoring and control with multiple sensors.

The menu-based software is easy to use and configure, and available in German, English, French, Dutch, Spanish, Russian and Portuguese. The software includes adjustable signal damping, 16 linearization tables and advanced calculation capabilities. Multiple outputs transmit the measurements in real-time for precise process control. An integrated data logger captures vital process information for quality assurance and plant control records.

This data is easily transferred to a PC via an RS232 port.

### C4000 - Photometric Converter

The Control 4000 photometric converter is designed for optek ultraviolet (UV), visible (VIS), near-infrared (NIR) absorption based and scattered light based sensors.

The graphic display can show absorbance, transmittance and concentration in real-time and in any unit of measure such as CU, OD, %-Tr., ppm (DE), EBC, FTU, g/L and many others.

These measurements may also be displayed as text, bar graphs or trend values. A factory zero is implemented as an additional feature for scattered light sensors. A secondary user zero for additional offset is included, as well as a slope and shift adjustment. This manual adjustment can be used to compensate for long-term process related disturbances.

### C8000 - Universal Converter

The Control 8000 universal converter operates optek photometric sensors along with 2 pH-probes and 2 conductivity sensors (optek ACx series) simultaneously.

All measurements (2 x optical, 2 x pH, 2 x conductivity and 2 x temperature) are transmitted with the standard 8 mA-outputs and may also be displayed as text and bar graphs.

The combination of C8000 and ACF60 or ACS60 conductivity sensors allows a wide dynamic range from 0 – 10 µS/cm up to 0 – 850 mS/cm with the same sensor.

Sensors	C4000	C8000
Optical sensors (optek)	1 - 4	1 - 2
pH-Probes	—	2
Conductivity sensors (optek)	—	2
Communications	C4000	C8000
mA-outputs (0/4 - 20 mA)	2 / 4	8
mA-inputs (4 - 20 mA)	0 / 2	—
Relay-outputs	3	—
Failsafe-relay (active)	✓	✓
Remote-IN: Zero	✓	✓
Remote-IN: Range	✓	✓
Remote-IN: Hold	✓	—
Profibus® PA	✓	—
FOUNDATION™ Fieldbus	✓	✓
Explosion-Proof	C4000	C8000
Ex-proof ATEX	✓	—
Ex-proof FM	✓	—

# 04 | C4000 - Photometric Converter



The Control 4000 is available in various configurations to meet the exact needs of your process.

- Multiple photometric sensors
- Multiple parameter sets
- Multiple linearization tables
- Data logger
- Factory zero for scattered light sensors
- Remote control
- Ex proof versions FM and ATEX

Sensor				4101	4201	4202	—
1	2	3	4	4121	4221	4222	4422
				4151	4251	4252	4452
				4161	4261	4262	4462
AF16 (AS16)	—	—	—	✓	✓	✓	✓
AF16 (AS16)	AF16 (AS16)	—	—	—	—	✓	✓
AF16 (AS16)	AF26 or AF45 or TF16	—	—	—	—	—	✓
AF26	—	—	—	—	✓	✓	✓
AF26	AF26 or AF45 or TF16	—	—	—	—	—	✓
AF45	—	—	—	—	✓	✓	✓
AF45	AF45 or TF16	—	—	—	—	—	✓
AF46	—	—	—	—	—	—	✓
TF16	—	—	—	—	✓	✓	✓
TF16	TF16	—	—	—	—	—	✓
ASD12 or ASD25	—	—	—	✓	✓	✓	✓
ASD12 or ASD25	ASD12 or ASD25	—	—	—	✓	✓	✓
ASD12 or ASD25	ASD12 or ASD25	ASD12 or ASD25	—	—	—	—	✓
ASD12 or ASD25	ASD12 or ASD25	ASD12 or ASD25	ASD12 or ASD25	—	—	—	✓

\*C4422 can handle up to 4 sensors AS56

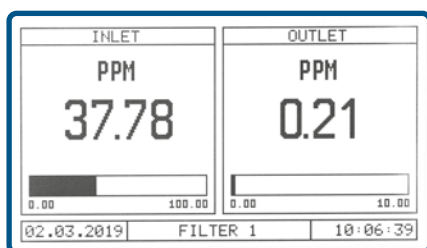

### Display Modes

- 1 - 4 simultaneously displayed values (configurable)
- Numeric with bar graph and alarm setting
- Trendline

### Remote Control

- Parameter set (e.g. range)
- Zero
- Hold

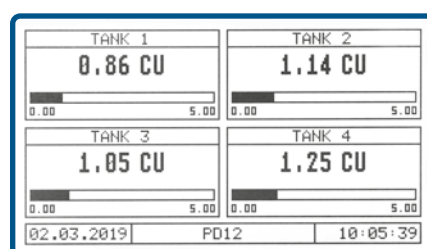

### Software Tools

- 8 parameter sets (incl. range, alarm, display, etc.)
- 16 linearization tables (max. 11 points)
- 8 offset and slope sets
- Auto zero (local or remotely activated)
- Factory zero (scattered light sensors only)
- Password protection (3 levels and none)
- Memory (non-volatile) retains all configurations and logged data



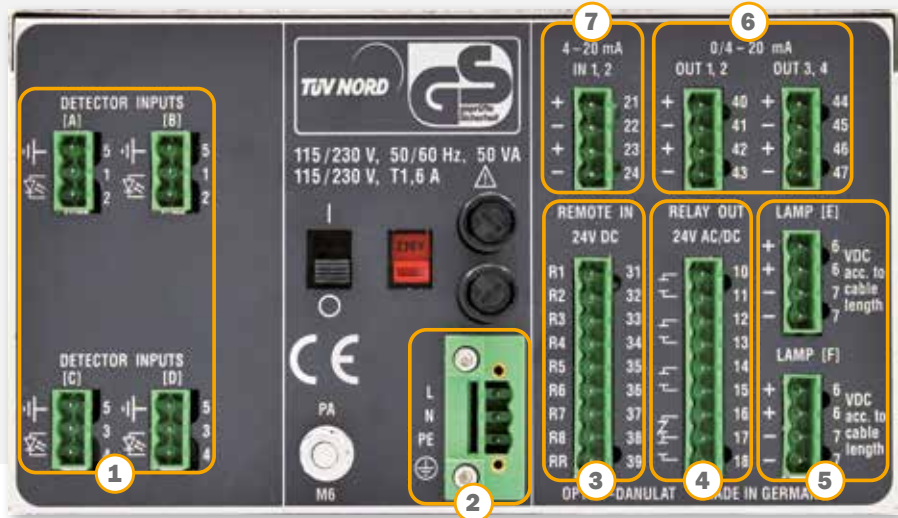
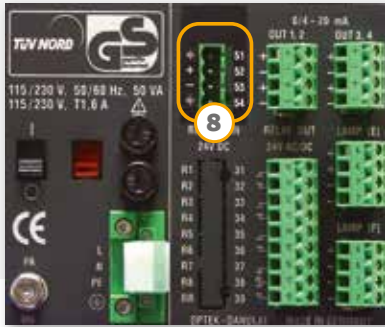

C4000 Configuration		4101	4201	4202	4121		4221		4222		4422	
<b>Profibus® PA</b>	8					4151		4251		4252		4452
<b>FOUNDATION™ Fieldbus</b>						4161		4261		4262		4462
Detector inputs (optek)	1	1	2	2	1	1	2	2	2	2	4	4
Power supply 115/230 or 24 V	2	✓	✓	✓	✓	✓	✓	✓	✓	✓	✓	✓
Remote-IN: (Zero, Range, Hold)	3	—	—	—	✓	—	✓	—	✓	—	✓	—
Relay-outputs	4	3	3	3	3	3	3	3	3	3	3	3
Failsafe-relay (active)		✓	✓	✓	✓	✓	✓	✓	✓	✓	✓	✓
Lamp outputs (optek)	5	1	1	2	1	1	1	1	2	2	2	2
mA-outputs (0/4 - 20 mA)	6	2	2	4	2	2	2	2	4	4	4	4
mA-inputs (4 -20 mA)	7	—	—	—	2	—	2	—	2	—	2	—
pH-probe		— (with C8000 / C82x only)										
Conductivity (optek ACF / ACS)		— (with C8000 / C82x only)										
Ex-proof (optional)		✓	✓	✓	✓	✓	✓	✓	✓	✓	✓	✓



## PROFIBUS® PA

- Fulfills application profile for process automation (version 3.01)
- Cyclic:
  - 4 measuring outputs, each with 4x limit and status
  - Status of all 4 relays
  - 2 measuring inputs
- Acyclic:
  - Zero, Hold, Product change, Monitors, Error codes
- GSD, EDD file and DTM for FDT interface provided
- Interface to profibus DP segment using a segment coupler

## FOUNDATION™ Fieldbus

- Fulfills FOUNDATION™ Fieldbus H1 (IEC 61158-2)
- Registered function blocks: 1xRB, 8xAI(s), 4xDI(s), 2xAO(s)
- H1 Profile class: 31P, 32L
- H1 Device class: basic, link master
- 4 Measuring outputs with status (C8000 8 measuring outputs with status)
- 4 Relays with status (C8000 1 Relay with status)
- 2 Measuring inputs (only C4000)
- With optek specific resource block parameter: Zero, Hold, Product change
- Device description (DD) and capabilities files provided

# 06 | C8000 - Universal Converter



C8000 Sensor Combination		
1 AF, AS or TF Sensor or 2 ASD Sensors		
AF16	VIS-NIR Absorption	1
AS16	VIS-NIR Absorption	1
AF26	Dual Channel Color	1
AF45	UV-Absorption	1
AF46	Dual Channel UV	1
TF16	11° Scattered Light	1
ASD12	NIR Absorption	2
ASD25	NIR Absorption	2
4 Electrochemical Sensors		
pH-probe		2
Conductivity (optek ACF / ACS)		2

The Control 8000 is available in various configurations to meet the exact needs of your process.

- 1 or 2 photometric sensors
- 2 conductivity sensors
- 2 pH sensors
- Multiple parameter sets
- Multiple linearization tables
- Data logger
- Factory zero for scattered light sensors
- Remote control

## Software Tools

- 8 parameter sets (incl. range, display etc.)
- 16 linearization tables (max. 11 points)
- 8 offset and slope sets
- Auto zero (local or remotely activated)
- Factory zero (scattered light sensors only)
- Password protection (3 levels and none)
- Memory (non-volatile) retains all configurations and logged data

## Remote Control

- Parameter set
- Zero

## Display Modes

- 2 - 8 simultaneously displayed values (configurable)
- Numeric with bar graph

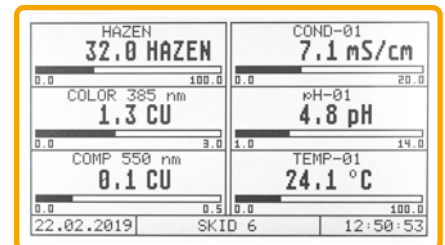
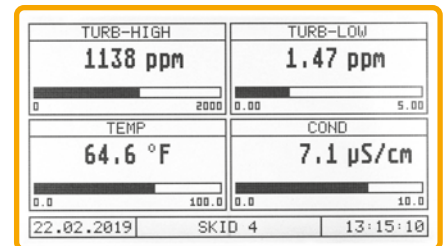
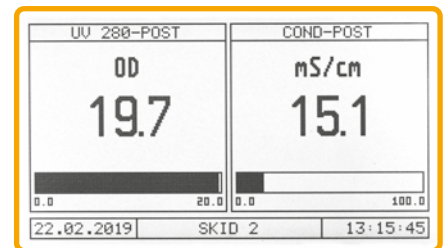

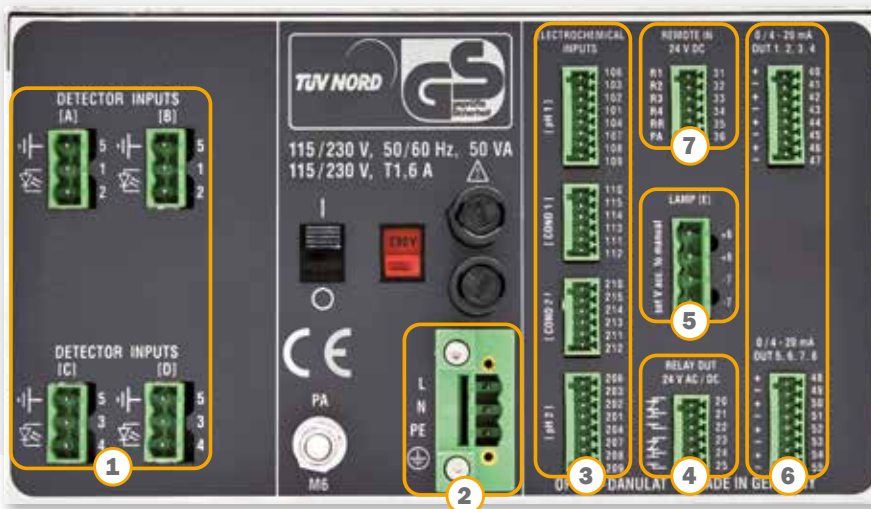
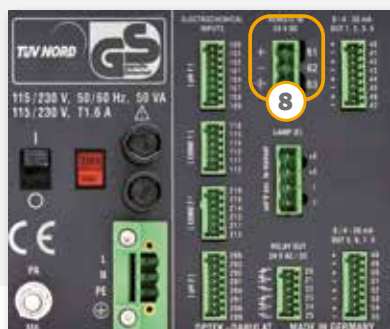

## 8 Measurements

## 5 Sensors

## 3 Armatures

## 1 Converter

The C8000 provides optical density or forward scatter turbidity measurements in the ultraviolet (UV), visible (VIS), and near infrared (NIR) ranges. In addition to optical sensors, the C8000 monitors up to two pH sensors and two conductivity sensors with integrated temperature measurements. One converter assures easy operation with an intuitive user interface in a compact package.

C8000 - Configuration	C8480	C8486	C8080	C8086
Detector inputs (optek)	① 4	4	—	—
Power supply 115/230 or 24 V	② ✓	✓	✓	✓
Remote-IN: (Zero, Range)	⑦ ✓	—	✓	—
Relay-outputs		—	—	—
Failsafe-relay (active)	④ ✓	✓	✓	✓
Lamp output (optek)	⑤ ✓	✓	—	—
mA-outputs (0/4 - 20 mA)	⑥ 8	8	8	8
mA-inputs (4 -20 mA)		(with C4000 only)		
Profibus® PA		(with C4000 only)		
FOUNDATION™ Fieldbus	⑧ —	✓	—	✓
pH-probe	③	2	2	2
Conductivity (optek ACF / ACS)		2	2	2
Ex-proof (optional)		(with C4000 only)		

### Application (example):

#### Pre- and post-column chromatography monitoring

During purification, accurate, reliable and repeatable measurements are necessary to ensure accurate pooling to maximize yields and protein/DNA fraction purity.

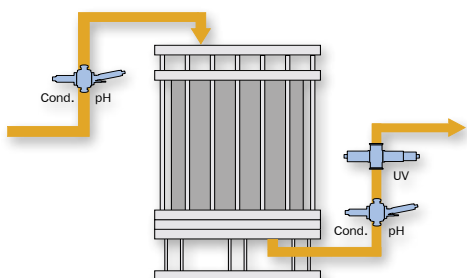

1 Converter	3 Armatures	5 Sensors	8 Measurements
C8480	Line size: 0.50 in. Clamp TC L14 AM7 PN: 0120-3507-33 OPL: 5 mm  Volume: < 22 ml Height: 96 mm (3.78 in.)	AF46 Dual Channel UV Absorption	UV Absorption at 280 nm  UV Absorption at 300 nm
	Line size: 0.50 in. Clamp TC L14 AM7 PN: 0120-3508-33 F - value: 40 mm  Volume: < 44 ml Height: 96 mm (3.78 in.)	ACF60 (6 electrode probe based on 4 pole technique)  PF12 (various pH electrodes)	Conductivity 0 - 10 µS/cm to 0 - 850 mS/cm  Temperature -10 °C - 135 °C (14 - 275 °F)  pH 0 - 14 pH
	Line size: 0.50 in. Clamp TC L14 AM7 PN: 0120-3508-33 F - value: 40 mm  Volume: < 44 ml Height: 96 mm (3.78 in.)	ACF60 (6 electrode probe based on 4 pole technique)  PF12 (various pH electrodes)	Conductivity 0 - 10 µS/cm to 0 - 850 mS/cm  Temperature -10 °C - 135 °C (14 - 275 °F)  pH 0 - 14 pH
	Volume: < 44 ml Height: 96 mm (3.78 in.)	PF12 (various pH electrodes)	pH 0 - 14 pH

## 08 | C4000/C8000 - Accessories

The PC-Transfer software allows communication between converter and PC via a RS-232 port. Documentation and set-up including identical set-up of multiple converters are made simple.

**Converter to PC:**

- Parameter set
- Trend data online
- Data logger

**PC to converter:**

- Parameter set
- Software update
- Mathematics module (C4000 only)

The advanced version features an additional mathematics module for complex measuring tasks and parameter creation on the PC.

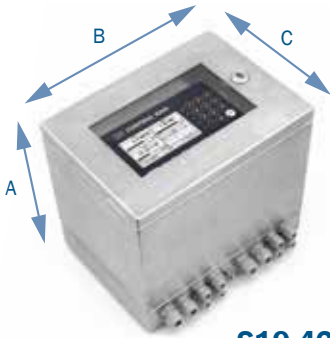

### S19-42

Wall mount housing (IP65)  
Material: stainless steel 1.4301 / SS 304  
A: 301 mm (11.9 in.)  
B: 340 mm (13.4 in.)  
C: 237 mm (9.4 in.)



### B19-42

Wall mount housing (IP66)  
Material: plastic (ABS)  
A: 287 mm (11.3 in.)  
B: 353 mm (13.9 in.)  
C: 147 mm (5.8 in.)  
D: 237 mm (9.4 in.)

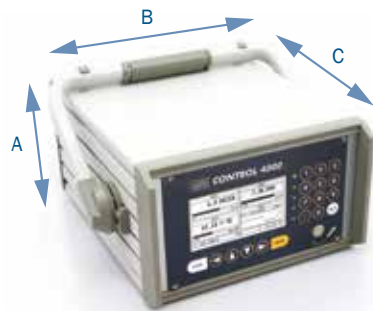

### T19-42

Table top housing  
Material: aluminum  
A: 150 mm (5.9 in.)  
B: 260 mm (10.2 in.)  
C: 320 mm (12.6 in.)

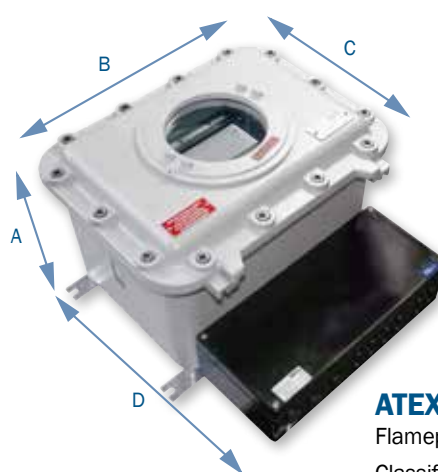

### ATEX EX d

Flameproof housing EX d (IP65)  
Classification:  
II 2(2) G Ex de [ia Gb] IIB+ H2 T5 Gb  
Approval:  
KEMA 08 ATEX 0123  
Material: cast aluminum  
A: 320 mm (12.6 in.)  
B: 450 mm (17.7 in.)  
C: 355 mm (14.0 in.)  
D: 500 mm (19.7 in.)

### Front-Kit

Front panel mounting (IP65 - front only)  
(not shown)





# C4000/C8000 - Technical Data | 09

Technical Data	C4000	C8000
<b>Housing</b>	19"- version for mounting in control cabinets 3 U / 42 HP - dimensions: W 213.0 mm (8.39 in.) H 128.4 mm (5.06 in.) D 230.0 mm (9.05 in.) - material: stainless steel / polyester / silicone / glass / diverse plastics - protection: front IP40 / rear IP20 (mains supply secured against accidental touching)	
<b>Display</b>	LCD graphic display black on white (240 x 128 pixel), LED background illuminated	
<b>Operation</b>	18-button keyboard	
<b>System clock</b>	accuracy approx. 1 minute/month (battery life approx. 15 years)	
<b>LED</b>	1 LED (green): power on 1 LED (red-flashing): system failure 3 LEDs (yellow): alarm I, II, III	1 LED (green): power on 1 LED (red-flashing): system failure
<b>Data logger</b>	4 parallel measuring values (ring buffer with approx. 25,000 data points x 4) (interval: 1/second - 1/hour)	8 parallel measuring values (ring buffer with approx. 12,500 data points x 8) (interval: 1/second - 1/hour)
<b>Sensor-inputs</b>	1 to 4 for optek photometric sensors n/a n/a	4 for optek photometric sensors 2 for optek conductivity sensors 2 for pH-probes (temperature compensated)
<b>Sensor-inputs (explosion proof)</b>	optional: 1 - 4 for optek photometric sensors (intrinsic safe)	n/a
<b>mA-inputs</b>	optional: 2 x 4 - 20 mA (functionally galvanically isolated) - accuracy: < 0.5% - resolution: < 0.05% - load: < 200 Ohm	n/a
<b>Remote-inputs</b>	optional: 7 x 24 V (19 ... 29 V DC), typically 6.0 mA for remote range setting, remote zero, remote hold	standard: 4 x 24 V (19 - 29 V DC), typically 6.0 mA for remote range setting, remote zero
<b>Profibus® PA interface</b>	optional: Profibus® PA profile, version 3.01, amendment 2	n/a
<b>FOUNDATION™ Fieldbus interface</b>	optional: FOUNDATION™ Fieldbus H1 (IEC 61158-2)	
<b>Sensor lamp-outputs</b>	1 or 2 lamp supply for optek photometric sensors 4.5 ... 8.5 V DC	1 lamp supply for optek photometric sensors 4.5 ... 7.8 V DC
<b>mA-outputs</b>	2 or 4 x 0/4 - 20 mA (NAMUR) (functionally galvanically isolated) - accuracy: < 0.5% - resolution: < 0.05% - load: < 600 Ohm	8 x 0/4 - 20 mA (NAMUR) (functionally galvanically isolated) - accuracy: < 0.5% - resolution: < 0.05% - load: < 600 Ohm
<b>Relay-outputs</b>	3 independent software-configurable relay contacts 0 - 50 V AC, 0 - 75 V DC, 0 - 2 A - for alarm or status feedback - initiation delay configurable: 0 - 999 sec.	n/a
<b>Failsafe-output</b>	1 SPDT contact to alarm in case of lamp or system failure (active) 0 - 50 V AC, 0 - 75 V DC, 0 - 2 A	
<b>Serial communication</b>	RS232 bi-directional interface on front panel (with software package optek PC-transfer) upload / download of configuration, download of data logger content	
<b>Cable lengths (sensor)</b>	2, 3, 5, 10, 15, 20, 30 ... 100 m (7, 10, 16, 33, 49, 66, 98 ... 328 ft) cable length > 100 m on request up to 1,000 m (3,280 ft) sensors AS56 / AS16: max: 50 m sensors ASD: 2, 3, 5 or 10 m (7, 10, 16 or 33 ft.)	2, 3, 5, 10, 15, 20, 30 m (7, 10, 16, 33, 49, 66, 98 ft) sensors ASD: 2, 3, 5 or 10 m (7, 10, 16 or 33 ft.)
<b>Power supply</b>	115 / 230 V AC, selectable (93.5 - 132 / 187 - 264 V AC, 47 - 64 Hz) or 24 V AC / DC (AC: 20.4 - 26.4 V AC, 47 - 64 Hz; DC: 20.4 - 28.8 V DC) power consumption: < 50 VA	
<b>Ambient conditions</b>	temperature during operation (no direct sunlight): - converter: -10 - 55 °C (14 - 131 °F) - with optional stainless steel housing S19-42 (IP65): -20 - 45 °C (-4 - 113 °F) - with optional plastic housing B19-42 (IP66): -10 - 40 °C (14 - 104 °F) (C4000 only) - with optional EX d housing (IP65): -20 - 40 °C (-4 - 104 °F) (C4000 only) temperature during transport (no direct sunlight) : -20 - 70 °C (-4 - 158 °F)	
<b>Software languages</b>	English, German, French, Spanish, Dutch, Portuguese, Russian	

Data given are subject to changes without prior notice.

# 10 | Optical Sensors Overview

Sensor Specifications								
	ASD	AS16	AS56	AF16	AF26	AF45	AF46	TF16
<b>Basic Measuring Principle:</b>	①	②	②	③	④	⑤	⑥	⑦
Absorption of light - 1-channel	✓	✓	✓	✓	✓	✓	✓	✓
Absorption of light - 2-channel	—	—	—	—	✓	—	✓	—
Scattering of light - 11°	—	—	—	—	—	—	—	✓
<b>Basic Measuring Ranges:</b>								
CU / AU / OD / %-Tr.	✓	✓	✓	✓	✓	✓	✓	✓
ppm / FTU / EBC	—	—	—	—	—	—	—	✓
<b>Wavelengths Used:</b>								
NIR (840 - 910 nm)	✓	—	—	—	—	—	—	—
NIR (730 - 970 nm) - Turbidity	—	AS16-N	AS56-N	AF16-N	—	—	—	✓
VIS (385 - 1000 nm) - Color	—	—	—	AF16-F	✓	—	—	—
VIS (430 - 620 nm) - Color	—	AS16-F	AS56-F	AF16-F	✓	—	—	—
UV (254 - 313 nm)	—	—	—	—	—	✓	✓	—
<b>Windows and OPL:</b>								
Window material: Pyrex®	—	—	—	✓	✓	—	—	✓
Window material: Sapphire	✓	✓	✓	✓	✓	✓	✓	✓
OPL (optical path length) mm	(*)	1 - 40	5 / 10	1 - 1000	1 - 1000	1 - 160	1 - 160	40
Window gaskets (various)	n/a	n/a	n/a	✓	✓	✓	✓	✓
<b>Process Adaption:</b>								
Armature in pipe	—	—	—	✓	✓	✓	✓	✓
Insertion through port	✓	✓	✓	—	—	—	—	—
<b>Process Ratings:</b>								
Max. pressure up to bar (psi)	(*)	20 (290)	10 (145)	100 (1450) depending on materials and design (higher on request)				
Max. temperature up to °C (°F) - continuously	(*)	100 (212)	90 (194)	120 (248)	120 (248)	70 (158)	70 (158)	120 (248)
<b>Options:</b>								
HT (high temperature) up to °C (°F) - continuously	—	—	—	240 (464)	240 (464)	120 (248)	120 (248)	240 (464)
VB (calibration adapter)	—	✓	—	✓	✓	✓	✓	—
EX-proof ATEX	—	—	—	✓	✓	✓	✓	✓
EX-proof FM	—	—	—	✓	✓	✓	✓	✓

\* See individual sensor data for details

Pressure and temperature ratings specified herein may be subject to limitations - see instruction manual.  
The appropriate choice of material for all wetted parts is the sole responsibility of the user. Data given are subject to changes without prior notice.

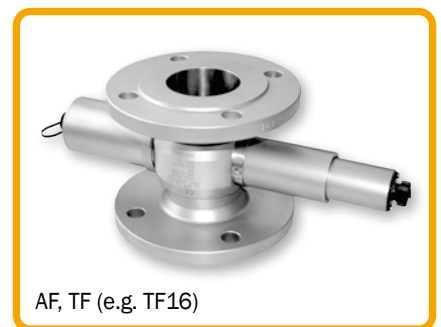

**① Probe ASD12 / ASD25**

NIR-Absorption,  
single channel concentration measurement

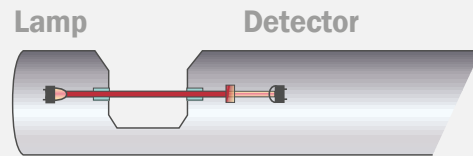

**② Probe AS16 / AS56**

VIS- and NIR-Absorption,  
single channel concentration and  
color measurement

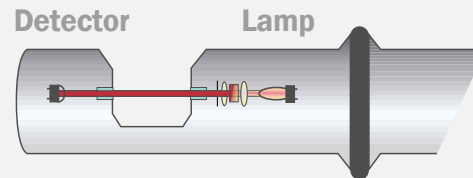

**③ Sensor AF16**

VIS- and NIR-Absorption,  
single channel concentration  
and color measurement

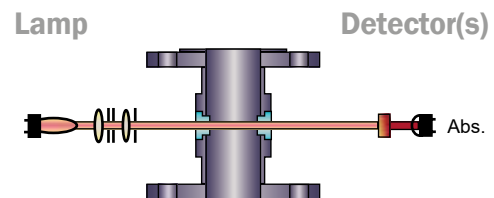

**④ Sensor AF26**

VIS-Absorption,  
dual channel color measurement  
with turbidity compensation

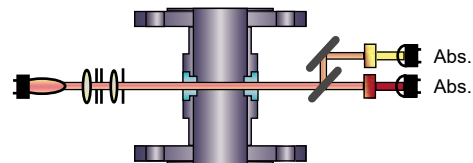

**⑤ Sensor AF45**

UV-Absorption,  
single channel concentration measurement  
with compensation of lamp intensity

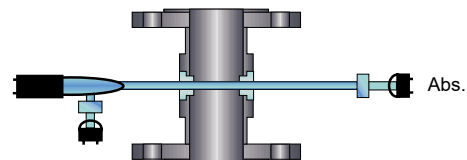

**⑥ Sensor AF46**

UV-Absorption,  
dual channel concentration measurement  
with compensation of lamp intensity

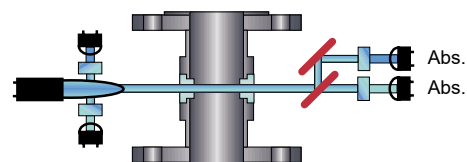

**⑦ Sensor TF16**

11° scattered light and NIR-Absorption  
dual channel turbidity measurement

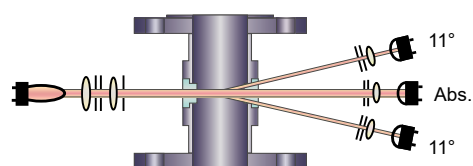

# 12 | Turbidity Sensors AF16-N/TF16-N

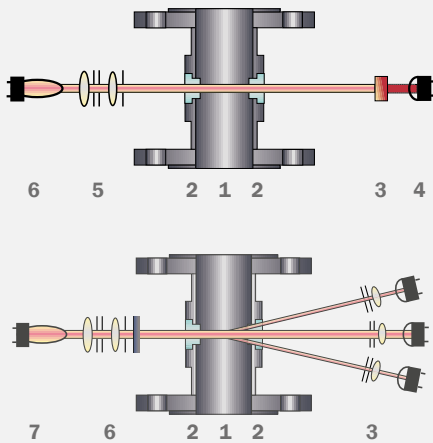

### ③ Model AF16-N Single Channel Absorption (NIR)

- |                 |                        |
|-----------------|------------------------|
| 1 Sensor body   | 2 Windows              |
| 3 Filter        | 4 Measurement detector |
| 5 Optics module | 6 Lamp module          |

### ⑦ Model TF16-N Dual Channel Scattered Light (11°)

- |                       |                      |
|-----------------------|----------------------|
| 1 Sensor body         | 2 Windows            |
| 3 Focusing optics     | 4 Detector 0° (Abs.) |
| 5 Eight 11° detectors | 6 Optics module      |
| 7 Lamp module         |                      |

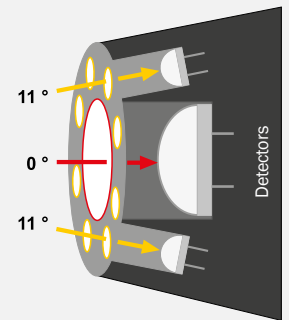

Models AF16-N and TF16-N are high precision turbidity sensors for use in various industries. The sensors are designed for inline operation and provide accurate concentration measurements with remarkable repeatability, linearity and resolution.

Modular construction of the sensors offers maximum flexibility in adapting to various process needs. Options include electro-polished sensor bodies, hazardous location (explosion-proof) capability, chemical resistant materials (sapphire windows, titanium, Hastelloy, etc.) and high temperature or high pressure versions.

### AF16-N (NIR-Absorption / Turbidity)

A special tungsten lamp produces a constant light beam that passes through the process medium. The attenuation of the light intensity, caused by absorption and/or scattering by dissolved and immiscible liquids, is detected by a sealed silicon photodiode.

The AF16-N uses light from 730 - 970 nm (NIR) to measure solids concentration independent from color or color changes. Depending on the optical path length, measuring ranges from high percentage (OPL = 1 mm) to 0 - 100 ppm (OPL = 160 mm) are possible.

### TF16-N (Scattered Light / Turbidity)

Light scattered from particles (trace suspended solids, immiscible liquids or gas bubbles) in the medium is detected by eight hermetically sealed silicon photodiodes at an angle of 11°. At the same time, the unscattered light is detected by a reference photodiode (comparable to an AF16-N). The sensor can be calibrated in ppm (DE), EBC or FTU and measures extremely low particle sizes and concentrations. Additionally, high particle concentrations can be monitored independent of color at the direct light detector.

### OPL

Special optical windows are made from a single crystal sapphire, providing superior resistance to all abrasive and corrosive media. With the appropriate choice of sensor bodies and windows in various lengths, the optimal OPL

(optical path length = distance between the windows) can be achieved to meet the measurement requirements, i.e., low/high measuring ranges at highest resolution.

### Typical Applications:

- Separator control, pulp concentration (AF16-N)
- Filter control, oil in water (TF16-N)

See our **TOP 5 brochures for applications in your industry.**



optek TF16-EX-HT-N  
Scattered Light Dual Channel Turbidity Sensor





# Turbidity Sensors AF16-N/TF16-N | 13

Technical Data	AF16-N (Turbidity)	TF16-N (Turbidity)
<b>Measurement</b>		
<b>Measurement principle</b>	1- Channel absorption of light	1- Channel absorption of light and 2- Channel scattering of light (11°)
<b>Measurement wavelength</b>	730 nm - 970 nm	730 nm - 970 nm
<b>Detector(s)</b>	1 silicon photodiode (hermetically sealed)	1 silicon photodiode (hermetically sealed) (Abs.) 8 silicon photodiodes (hermetically sealed) (11°)
<b>Measuring range NIR-Absorption</b>	any measuring range between 0 - 0.05 to 6 CU 0 - 50 to 40,000 ppm (DE) 0 - 20 to 16,000 FTU 0 - 5 to 4,000 EBC	any measuring range between 0 - 0.05 to 5 CU 0 - 50 to 8,000 ppm (DE) 0 - 20 to 3,200 FTU 0 - 5 to 800 EBC
<b>Measuring range Scattered Light (11°)</b>	n/a	any measuring range between 0 - 0.5 to 500 ppm (DE) 0 - 0.2 to 200 FTU 0 - 0.05 to 50 EBC (higher [i.e. 100 EBC] with reduced resolution, accuracy)
<b>Optical path length</b>	1 - 1000 mm	40 mm standard (10 - 60 mm with reduced accuracy)
<b>Calibration</b>	Abs.: CU (concentration units) application specific calibration	Abs.: CU (concentration units) application specific calibration basic calibration 11°: in ppm (DE) / FTU / EBC
<b>Light source</b>	special incandescent tungsten lamp 5.0 V DC, 970 mA typical life span: 3 to 5 years (25,000 to 40,000 hours)	
<b>Resolution</b>	< ± 0.05% of respective measuring range	
<b>Repeatability</b>	< ± 0.5% of respective measuring range (scattered light < ± 0.3%)	
<b>Linearity</b>	< ± 1% of respective measuring range (specific to application)	
<b>Protection</b>	all optical parts have an IP rating of IP65 or higher	
<b>Sensor Body</b>		
<b>Material</b>	Stainless steel 1.4435 (SS 316L), 1.4539 (904 L), 1.4571 (SS 316Ti), 1.4462 (318 LN), Titanium 3.7035 (Grade 2), Hastelloy 2.4602 (C22), Plastic TFM™ 4215 ... others on request	
<b>Line size</b>	1/8 in. to 6 in. (DN 6 to DN 150), ... others on request	
<b>Process connection</b>	Flanges (ASME, DIN, EN, JIS), Clamps (TC, ISO, DIN), Female Threads (NPT, DIN), Sanitary Threads (DIN 11851), Tube Ends (DIN, ISO, OD), DIN 11864-1/-2/-3 (DIN, ISO, OD), Varivent (DIN, IPS, OD), ... others on request	
<b>Process pressure</b>	0 - 100 bar (0 - 1450 psi) - higher on request depending on process connection, materials and design	
<b>Windows</b>	1-Pyrex®, 2-Sapphire, 3-Sapphire Biotech	
<b>Window gaskets</b>	Silicone (FDA), Viton® (FDA), EPDM / Kalrez® 6230 (FDA / USP Class VI), Kalrez® 4079 ... others on request	
<b>Temperature Ratings</b>		
<b>Process temperature</b>	permanent: 0 - 120 °C (32 - 248 °F) / peak 15 min/day: 0 - 150 °C (32 - 302 °F)	
<b>Process temperature OPTION HT</b>	permanent: -30 - 240 °C (-22 - 464 °F) / peak 15 min/day: -30 - 260 °C (-22 - 500 °F)	
<b>Process temperature OPTION EX</b>	permanent: -30 - 120 °C (-22 - 248 °F) / peak 15 min/day: -30 - 150 °C (-22 - 302 °F)	
<b>Process temperature OPTION EX-HT</b>	permanent: -30 - 240 °C (-22 - 464 °F) / peak 15 min/day: -30 - 260 °C (-22 - 500 °F)	
<b>Ambient temperature</b>	operation: 0 - 40 °C (32 - 104 °F) operation: -30 - 40 °C (-22 - 104 °F) with options HT / EX / EX-HT transport: -20 - 70 °C (-4 - 158 °F)	
<b>Explosion Proof</b>		
<b>Ex-proof</b>	none	
<b>Ex-proof OPTION EX (EN-D)</b>	Sensor assembly in ex-proof version acc. ATEX (EN-D)	Approval: DMT 02 ATEX E 175 X Approval: DMT 02 ATEX E 176 X
<b>Ex-proof OPTION EX (FM-D)</b>	Sensor assembly in ex-proof version acc. FM (FM-D)	Approval: FMG J. I. 3013884
<b>Calibration</b>		
<b>Calibration adapter</b>	none	n/a
<b>Calibration adapter OPTION VB</b> - recommended -	Filter adapter FH03 (detector side) for calibration filter used for sensor verification	n/a

Pressure and temperature ratings specified herein may be subject to limitations - see instruction manual.  
The appropriate choice of material for all wetted parts is the sole responsibility of the user.  
Data given are subject to changes without prior notice.

# 14 | Color Sensors AF16-F/AF26

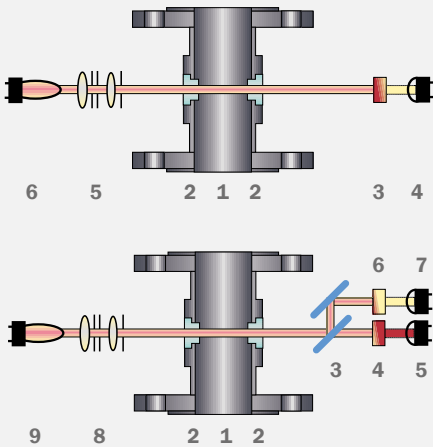

### 3 Model AF16-F Single Channel Absorption (VIS)

- |                 |                        |
|-----------------|------------------------|
| 1 Sensor body   | 2 Windows              |
| 3 Filter        | 4 Measurement detector |
| 5 Optics module | 6 Lamp module          |

### 4 Model AF26 Dual Channel Absorption (VIS-NIR)

- |                          |                 |
|--------------------------|-----------------|
| 1 Sensor body            | 2 Windows       |
| 3 Beam splitter          | 4 Filter A      |
| 5 Measurement detector A | 6 Filter B      |
| 7 Measurement detector B | 8 Optics module |
| 9 Lamp module            |                 |

Models AF16-F and AF26 are high precision color sensors used to measure color or color changes in various industries. The sensors are designed for inline operation and provide accurate concentration measurements with remarkable repeatability, linearity and resolution.

Modular construction of the sensors offers maximum flexibility in adapting to various process needs. Options include electro-polished sensor bodies, hazardous location (explosion-proof) capability, chemical resistant materials (sapphire windows, titanium, Hastelloy, etc.) and high temperature or high pressure versions.

### VIS-Absorption (Color)

A special tungsten lamp produces a constant light beam that passes through the process medium. The attenuation of the light intensity, caused by absorption and/or scattering by dissolved and undissolved substances, is detected by sealed silicon photodiodes.

At a specific wavelength in the visible range (385 - 750 nm) there is a loss of light as a result of an increase in color depth. optek sensors measure in various color scales such as Hazen, APHA, ASTM, EBC, Gardner, Saybolt, and many more. Also, many dissolved substances in liquids can be precisely

monitored using color measurements. For instance, increasing iron or nickel contents result in a yellow liquid.

### OPL

Special optical windows are made from a single crystal sapphire, providing superior resistance to all abrasive and corrosive media. With the appropriate choice of sensor bodies and windows in various lengths, the optimal OPL (optical path length = distance between the windows) can be achieved to meet the measurement requirements, i.e., low/high measuring ranges at highest resolution.

### Dual Wavelengths

Selected combinations of optical filters make it possible to focus on specific wavelengths ensuring suitable adaptation to the application. While the AF16-F uses one wavelength, an AF26 is equipped with an internal beam splitter making it possible to measure two wavelengths simultaneously.

Connected to optek Control 4000 or Control 8000 converters, the second

wavelength can be used to compensate for (varying) background turbidity and any lamp intensity variation to assure the highest level of precision and long-term performance. Combined with a long optical path length, even the smallest color changes can be measured.

### NIST-traceable

NIST-traceable calibration accessories provide absolute measurement confidence (for details refer to page 27).

### Typical Applications:

- Monitoring in various color scales  
0-10 to 0-500 APHA Hazen,  
30 to -16 Saybolt,  
0-1 to 0-8 ASTM etc.
- Measuring various concentrations  
0-100 mg/l chlorine,  
0-5 mg/l iron in hydrochloric acid,  
0-100% chlorine gas,  
0-10 ppm to 0-15 g/l chlorine dioxide

See our **TOP 5 brochures for applications in your industry.**



optek AF26-VB Dual Channel Absorption Sensor with Calibration Adapter



Technical Data	AF16-F (Color)	AF26 (Color)
<b>Measurement</b>		
<b>Measurement principle</b>	1- Channel absorption of light	2- Channel absorption of light
<b>Measurement wavelength(s)</b>	385, 400, 430, 525, 750, 1000 nm, others on request	385/430, 385/550, 385/620, 400/550, 400/620, 420/700, 430/525, 430/620, 430/700, 460/620, 470/620, 470/700, 525/620, 525/700, 550/800, 620/800, 660/750, 670/550, 670/750, 1000/800 nm, others on request
<b>Detector(s)</b>	1 silicon photodiode (hermetically sealed)	2 silicon photodiodes (hermetically sealed)
<b>Measuring range</b>	any measuring range between 0 - 0.05 to 2.8 CU (dependent on filter used) <i>contact product specialist for application specific ranges</i>	any measuring range between 0 - 0.05 to 3 CU (dependent on filter used) <i>contact product specialist for application specific ranges</i>
<b>Optical path length</b>	1 - 1000 mm	
<b>Calibration</b>	CU (concentration units) application specific calibration	
<b>Light source</b>	special incandescent tungsten lamp 5.0 V DC, 970 mA typical life span: 3 to 5 years (25,000 to 40,000 hours)	
<b>Resolution</b>	< ± 0.05% of respective measuring range	
<b>Repeatability</b>	< ± 0.5% of respective measuring range	
<b>Linearity</b>	< ± 1% of respective measuring range (specific to application)	
<b>Protection</b>	all optical parts have an IP rating of IP65 or higher	
<b>Sensor Body</b>		
<b>Material</b>	Stainless steel 1.4435 (SS 316L), 1.4539 (904 L), 1.4571 (SS 316Ti), 1.4462 (318 LN), Titanium 3.7035 (Grade 2), Hastelloy 2.4602 (C22), Plastic TFM™ 4215, ... others on request	
<b>Line size</b>	1/8 in. to 6 in. (DN 6 to DN 150), ... others on request	
<b>Process connection</b>	Flanges (ASME, DIN, EN, JIS), Clamps (TC, ISO, DIN), Female Threads (NPT, DIN), Sanitary Threads (DIN 11851), Tube Ends (DIN, ISO, OD), DIN 11864-1/-2/-3 (DIN, ISO, OD), Varivent (DIN, IPS, OD), ... others on request	
<b>Process pressure</b>	0 - 100 bar (0 - 1450 psi) - higher on request depending on process connection, materials and design	
<b>Windows</b>	1-Pyrex®, 2-Sapphire, 3-Sapphire Biotech	
<b>Window gaskets</b>	Silicone (FDA), Viton® (FDA), EPDM / Kalrez® 6230 (FDA / USP Class VI), Kalrez® 4079, ... others on request	
<b>Temperature Ratings</b>		
<b>Process temperature</b>	permanent: 0 - 120 °C (32 - 248 °F) / peak 15 min/day: 0 - 150 °C (32 - 302 °F)	
<b>Process temperature OPTION HT</b>	permanent: -30 - 240 °C (-22 - 464 °F) / peak 15 min/day: -30 - 260 °C (-22 - 500 °F)	
<b>Process temperature OPTION EX</b>	permanent: -30 - 120 °C (-22 - 248 °F) / peak 15 min/day: -30 - 150 °C (-22 - 302 °F)	
<b>Process temperature OPTION EX-HT</b>	permanent: -30 - 240 °C (-22 - 464 °F) / peak 15 min/day: -30 - 260 °C (-22 - 500 °F)	
<b>Ambient temperature</b>	operation: 0 - 40 °C (32 - 104 °F) operation: -30 - 40 °C (-22 - 104 °F) with options HT / EX / EX-HT transport: -20 - 70 °C (-4 - 158 °F)	
<b>Explosion Proof</b>		
<b>Ex-proof</b>	none	
<b>Ex-proof OPTION EX (EN-D)</b>	Sensor assembly in ex-proof version acc. ATEX (EN-D)	Approval: DMT O2 ATEX E 175 X Approval: DMT O2 ATEX E 176 X
<b>Ex-proof OPTION EX (FM-D)</b>	Sensor assembly in ex-proof version acc. FM (FM-D)	Approval: FMG J. I. 3013884
<b>Calibration</b>		
<b>Calibration adapter</b>	none	
<b>Calibration adapter OPTION VB - recommended -</b>	Filter adapter FHO3 (detector side) for calibration filter used for sensor verification	

Pressure and temperature ratings specified herein may be subject to limitations - see instruction manual.  
The appropriate choice of material for all wetted parts is the sole responsibility of the user.  
Data given are subject to changes without prior notice.

# 16 | UV Sensors AF45/AF46

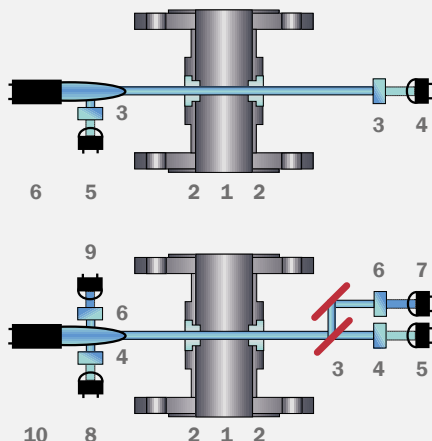

### 5 Model AF45 Single Channel Absorption (UV)

- |                      |                         |
|----------------------|-------------------------|
| 1 Sensor body        | 2 Windows               |
| 3 Filter             | 4 Measurement detector  |
| 5 Reference detector | 6 Lamp module (mercury) |

### 6 Model AF46 Dual Channel Absorption (UV)

- |                          |                          |
|--------------------------|--------------------------|
| 1 Sensor body            | 2 Windows                |
| 3 Beam splitter          | 4 Filter A               |
| 5 Measurement detector A | 6 Filter B               |
| 7 Measurement detector B | 8 Reference detector A   |
| 9 Reference detector B   | 10 Lamp module (mercury) |

Models AF45 and AF46 are high precision UV absorption sensors for use in the biotech and chemical industries. The sensors are designed for inline operation and provide accurate concentration measurements with remarkable repeatability, linearity and resolution.

Modular construction of the sensors offers maximum flexibility in adapting to various process needs. Options include electro-polished sensor bodies, hazardous location (explosion-proof) capability, chemical resistant materials (sapphire windows, titanium, Hastelloy, etc.) and high temperature or high pressure versions.

### UV-Absorption

A special mercury lamp produces a constant light beam that passes through the process medium. The attenuation of the light intensity, caused by absorption and/or scattering by dissolved and undissolved substances, is detected by sealed silicon photodiodes.

The light intensity of the lamp itself is measured by sealed silicon photodiodes using the same filter as the measurement wavelength. The sealed silicon photodiodes also compensate for any variances in lamp intensity, assuring the highest level of precision and long-term performance. Specific lamp design and capability of optek

converters operating with lowest photocurrents provide a prolonged life span at the lowest cost of ownership.

### OPL

Special optical windows are made from a single crystal sapphire, providing superior resistance to all abrasive and corrosive media. With the appropriate choice of sensor bodies and windows in various lengths, the optimal OPL (optical path length = distance between the windows) can be achieved to meet the measurement requirements, i.e., low/high measuring ranges at highest resolution.

### Dual Wavelengths

Selected combinations of optical filters make it possible to focus on specific wavelengths. Different peak wavelengths are available with a variety of bandwidth options ensuring suitable adaptation to the application.

While the AF45 uses one wavelength, an AF46 is equipped with an internal beam splitter making it possible to measure two wavelengths simultaneously. Connected to an optek Control 4000 or Control 8000 converter, a wide dynamic range is possible to measure at high and low values with one sensor in one setup. This ensures minimal hold-up volume and installation cost.

### NIST-traceable

NIST-traceable calibration accessories provide absolute measurement confidence (for details refer to page 27).

### Typical Applications:

- Monitoring of chromatographic columns (i.e., protein concentration)
- Measuring concentrations of aromatics

See our TOP 5 brochures for applications in your industry.



optek AF46-VB  
Dual Channel UV Absorption Sensor  
with Calibration Adapter



Technical Data	AF45 (UV)	AF46 (UV)
<b>Measurement</b>		
<b>Measurement principle</b>	1- Channel absorption of light	2- Channel absorption of light
<b>Measurement wavelength(s)</b>	254-13, 280-09, 280-13, 290-13, 300-13, 313-13 nm, ... others on request	254-13/280-13, 254-13/313-13, 280-09/300-05, 280-09/300-13, 280-09/313-13, 280-13/300-13, 280-13/313-13, 290-13/313-13 nm, ..... others on request
<b>Measuring detector(s)</b>	1 silicon photodiode (hermetically sealed)	2 silicon photodiodes (hermetically sealed)
<b>Reference detector(s)</b>	1 silicon photodiode (hermetically sealed)	2 silicon photodiodes (hermetically sealed)
<b>Measuring range</b>	any measuring range between 0 - 0.05 to 3 CU (dependent on filter used/ OPL) (contact product specialist for application specific ranges)	any measuring range between 0 - 0.05 to 2 CU (dependent on filter used/ OPL) (contact product specialist for application specific ranges)
<b>Optical path length</b>	1 - 160 mm	
<b>Calibration</b>	CU (concentration units) application specific calibration	
<b>Light source</b>	low pressure mercury lamp typical life span: 1 to 2 years (8,000 to 16,000 hours)	
<b>Resolution</b>	< ± 0.05% of respective measuring range	
<b>Repeatability</b>	< ± 0.5% of respective measuring range	
<b>Linearity</b>	< ± 1% of respective measuring range (specific to application)	
<b>Protection</b>	all optical parts have an IP rating of IP65 or higher	
<b>Sensor Body</b>		
<b>Material</b>	Stainless steel 1.4435 (SS 316L), 1.4539 (904 L), 1.4571 (SS 316Ti), 1.4462 (318 LN), Titanium 3.7035 (Grade 2), Hastelloy 2.4602 (C22), Plastic TFM™ 4215, ... others on request	
<b>Line size</b>	1/8 in. to 6 in. (DN 6 to DN 150), ... others on request	
<b>Process connection</b>	Flanges (ASME, DIN, JIS), Clamps (TC, ISO, DIN), Female Threads (NPT, DIN), Sanitary Threads (DIN 11851), Tube Ends (DIN, ISO, OD), DIN 11864-1/-2/-3 (DIN, ISO, OD), Varivent (DIN, IPS, OD), ... others on request	
<b>Process pressure</b>	0 - 100 bar (0 - 1450 psi) - higher on request depending on process connection, materials and design	
<b>Windows</b>	2-Sapphire, 3-Sapphire Biotech (do not use Pyrex®)	
<b>Window gaskets</b>	Viton® (FDA), EPDM / Kalrez® 6230 (FDA / USP Class VI), Kalrez® 4079, ... others on request (do not use Silicone)	
<b>Temperature Ratings</b>		
<b>Process temperature</b>	permanent: 0 - 70 °C (32 - 158 °F) / peak 15 min/day: 0 - 135 °C (32 - 275 °F) / peak 30 min/day: 0 - 120 °C (32 - 248 °F)	
<b>Process temperature OPTION HT</b>	permanent: -30 - 120 °C (-22 - 248 °F) / peak 15 min/day: -30 - 150 °C (-22 - 302 °F) / peak 30 min/day: -30 - 140 °C (-22 - 284 °F)	
<b>Process temperature OPTION EX</b>	permanent: -30 - 70 °C (-22 - 158 °F) / peak 15 min/day: -30 - 135 °C (-22 - 275 °F) / peak 30 min/day: -30 - 120 °C (-22 - 248 °F)	
<b>Process temperature OPTION EX-HT</b>	permanent: -30 - 120 °C (-22 - 248 °F) / peak 15 min/day: -30 - 150 °C (-22 - 302 °F) / peak 30 min/day: -30 - 140 °C (-22 - 284 °F)	
<b>Ambient temperature</b>	operation: 0 - 40 °C (32 - 104 °F) operation: -30 - 40 °C (-22 - 104 °F) with options HT / EX / EX-HT transport: -20 - 70 °C (-4 - 158 °F)	
<b>Explosion Proof</b>		
<b>Ex-proof</b>	none	
<b>Ex-proof OPTION EX (EN-D)</b>	Sensor assembly in ex-proof version acc. ATEX (EN-D)	Approval: DMT 02 ATEX E 175 X Approval: DMT 02 ATEX E 176 X
<b>Ex-proof OPTION EX (FM-D)</b>	Sensor assembly in ex-proof version acc. FM (FM-D)	Approval: FMG J. I. 3013884
<b>Calibration</b>		
<b>Calibration adapter VB</b>	Filter adapter FH03 (detector side) for calibration filter used for sensor verification	

Pressure and temperature ratings specified herein may be subject to limitations - see instruction manual.  
The appropriate choice of material for all wetted parts is the sole responsibility of the user.  
Data given are subject to changes without prior notice.

# 18 | Probe Sensors AS16/AS56

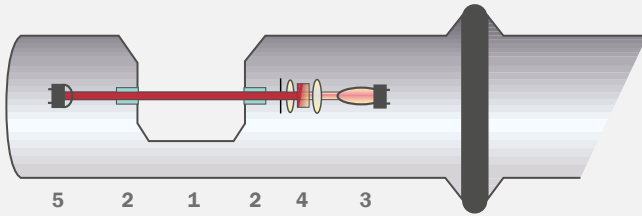

## ② Model AS16 (AS56) Single Channel Absorption

- 1 OPL
- 2 Windows
- 3 Lamp module
- 4 Optics modules (incl. filter)
- 5 Detector module

No window gaskets used

Models AS16 and AS56 are high precision sensors measuring turbidity (AS16-N and AS56-N) or color (AS16-F and AS56-F) for use in various industries. The sensors are designed for inline operation and provide accurate concentration measurements with remarkable repeatability, linearity and resolution.

### AS16

The AS16 series offers the high-end range of optek probe sensors. A wide selection of different optical path lengths and insertion depths combined with optional calibration filters and electro-polished stainless steel meet all requirements of the biotechnology industry.

### AS56

The AS56, based on the same design as the AS16 with seal-less window construction, is typically used in food and beverage applications. Limited variations allow cost effective measurement (e.g., phase separation).

### NIR-Absorption (Turbidity) VIS-Absorption (Color)

A special tungsten lamp produces a constant light beam that passes through the process medium. The attenuation of the light intensity, caused by absorption and/or scattering by dissolved and undissolved substances, is detected by a sealed silicon photo-

diode. The AS16-N and AS56-N uses light from 730 - 970 nm to measure solids concentration independent from color or color changes (e.g., yeast concentration in beer during tank draining).

The AS16-F and AS56-F uses a specific wavelength in the visible spectrum to measure color in liquids with little or no turbidity (e.g., beer in water during phase change).

### OPL

Special optical windows are made from a single crystal sapphire, providing superior resistance to all abrasive and corrosive media. optek's superior manufacturing techniques allow mounting the windows without gaskets or glue for lifetime without maintenance. The appropriate choice of the optimal OPL (optical path length = distance between the windows) supports all measurement requirements, i.e., low/high measuring ranges at highest resolution.

### NIST-traceable

NIST-traceable calibration accessories (AS16 only) provide absolute measurement confidence (for details refer to page 27).

### Typical Applications:

- Cell density in fermentation (AS16-N)
- Milk/water phase separation (AS56-N)
- Beverage blending (AS16-F)
- Beer/water phase separation (AS56-F)

See our **TOP 5 brochures for applications in your industry.**



optek AS16-VB-N Single Channel Absorption Probe



optek AS16-VB-N Single Channel Absorption Probe with Calibration Adapter

Technical Data	AS16	AS56
<b>Measurement</b>		
<b>Measurement principle</b>	1- Channel absorption of light	
<b>Detector</b>	1 silicon photodiode (hermetically sealed)	
<b>Measurement wavelength</b>	<ul style="list-style-type: none"> <li>AS16-N: 730 - 970 nm</li> <li>AS16-F: 430, 550 or 620 nm</li> </ul>	<ul style="list-style-type: none"> <li>AS56-N: 730 - 970 nm</li> <li>AS56-F: 430 nm</li> </ul>
<b>Measuring range</b>	AS16-N: any measuring range between 0 - 0.05 to 6 CU AS16-F: any measuring range between 0 - 0.05 to 2 CU (depending on wavelength)	AS56-N: any measuring range between 0 - 0.05 to 4 CU AS56-F: any measuring range between 0 - 0.05 to 1.5 CU
<b>Optical path length</b>	1, 5, 10, 20 or 40 mm	5 or 10 mm
<b>Calibration</b>	CU (concentration units) application specific calibration	
<b>Light source</b>	special incandescent tungsten lamp 5.0 V DC, 970 mA typical life span: 3 to 5 years (25,000 to 40,000 hours)	special incandescent tungsten lamp 5.0 V DC, 450 mA typical life span: 3 to 5 years (25,000 to 40,000 hours)
<b>Resolution</b>	< ± 0.05% of respective measuring range	< ± 0.5% of respective measuring range
<b>Repeatability</b>	< ± 0.5% of respective measuring range	< ± 1.0% of respective measuring range
<b>Linearity</b>	< ± 1% of respective measuring range (specific to application)	< ± 2% of respective measuring range (specific to application)
<b>Protection</b>	all optical parts have an IP rating of IP65 or higher	
<b>Process Adaption</b>		
<b>Material</b>	wetted parts: stainless steel 1.4435 (SS 316L) dF < 1%, BN2 surface: N5: Ra < 0.4 µm (16 µinch) - electropolished housing: stainless steel 1.4571 (SS 316Ti)	wetted parts: stainless steel 1.4435 (SS 316L) surface: N6: Ra < 0.8 µm (32 µinch) - electropolished housing: stainless steel 1.4571 (SS 316Ti)
<b>Port connection</b>	thread G1-1/4 in., ISO 228/1 for port AS25 (similar Ingold-port) diameter: 25 mm ( D = 25 H7) O-ring groove for 30 mm and for 60 mm port length	
<b>Port gasket</b>	O-ring 18.64 x 3.53 mm EPDM (FDA / USP Class VI)	
<b>Insertion depth</b>	35 mm (1.38 in.) + OPL at a port length of 60 mm (2.36 in.)	35 mm (1.38 in.) + OPL at a port length of 60 mm (2.36 in.)
	135 mm (5.31 in.) + OPL at a port length of 60 mm (2.36 in.)	n/a
<b>Process pressure</b>	0 - 20 bar (0 - 290 psi)	0 - 10 bar (0 - 145 psi)
<b>Windows</b>	sapphire (seal-less)	
<b>Window gaskets</b>	n/a	
<b>Installation accessories</b>	weld-in ports, Varivent adapter (50.00), clamp adapter (1.5 and 2.0 in.)	
<b>Temperature Ratings</b>		
<b>Process temperature</b>	permanent: 0 - 100 °C (32 - 212 °F) peak 60 min/day: 0 - 150 °C (32 - 302 °F) peak 90 min/day: 0 - 130 °C (32 - 266 °F)	permanent: 0 - 90 °C (32 - 194 °F) peak 60 min/day: 0 - 100 °C (32 - 212 °F)
<b>Ambient temperature</b>	operation: 0 - 40 °C (32 - 104 °F) transport: -20 - 70 °C (-4 - 158 °F)	
<b>Calibration</b>		
<b>Calibration adapter VB</b>	Filter adapter FH03 for calibration filter used for sensor verification	n/a

Pressure and temperature ratings specified herein may be subject to limitations - see instruction manual.  
The appropriate choice of material for all wetted parts is the sole responsibility of the user.  
Data given are subject to changes without prior notice.



## 20 | Probe Sensors ASD12-N / ASD25-N

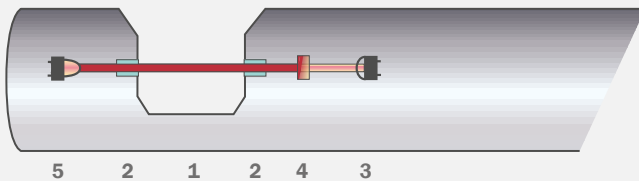

### ① Model ASD

- |                    |                    |
|--------------------|--------------------|
| 1 OPL              | 2 Sapphire windows |
| 3 Detector         | 4 Daylight filter  |
| 5 LED light source |                    |

No window gaskets used

The ASD12-N and ASD25-N absorption sensors are designed for use in pilot and production scale fermenters or bioreactors to precisely measure the growth of microbial or cell cultures as a function of NIR absorption.

### NIR-Absorption

A precisely defined and constant LED light beam penetrates the process medium. ASD12-N and ASD25-N use light from 840 nm to 910 nm (NIR). The attenuation of the light intensity, caused by absorption by dissolved substances and undissolved material is detected by a hermetically sealed photodiode.

### ASD12-N

The ASD12-N probe is specifically engineered for use in laboratory fermenters. The seal-less sapphire window design eliminates crevices and gaps to assure the highest level of sterility. All wetted parts are electro-polished steel. The ASD12-N is autoclavable and mounts conveniently through any head-plate with a PG13.5 threaded port. The ASD12-N is available in three different insertion depths with either 1, 5 or 10 mm OPLs (optical path length = distance between the windows). Shorter optical path lengths are typically used for dense cell cultures such as bacterial and yeast cultures. Longer OPLs are used for less dense cell cultures e.g., mammalian cells and dissolution / precipitation / crystallization reactions.

### ASD25-N / ASD25-BT-N

Models ASD25-N and ASD25-BT-N are designed for use in pilot or production scale fermenters or bioreactors. These extremely durable probes are designed for sanitary bioprocess environments and can be used in CIP/ SIP processes.

The ASD25-N is conveniently mounted through a standard 25 mm Ingold - type port and the ASD25-BT-N through a standard 25 mm safety port.

### Typical Applications:

- Cell growth in mammalian cell cultures and bacterial fermentation
- Algae concentration monitoring
- Biomass concentrations
- Crystallization process monitoring

See our **TOP 5 brochures for applications in your industry.**



Sapphire windows (seal-less)



optek ASD12-N  
Single Channel Absorption Probes



# Probe Sensors ASD12-N / ASD25-N | 21

Technical Data	ASD12-N	ASD25-N	ASD25-BT-N
<b>Measurement</b>			
<b>Measurement principle</b>	1-Channel absorption of light		
<b>Detector</b>	1-Silicon photodiode (hermetically sealed)		
<b>Measurement wavelength</b>	840 nm - 910 nm		
<b>Measuring range</b>	any measuring range between: 0 - 0,05 to 4 CU		
<b>Optical path length</b>	1, 5 or 10 mm	1, 5, 10 or 20 mm	
<b>Calibration</b>	CU (concentration units) application specific calibration		
<b>Light source</b>	Hybrid LED (hermetically sealed), 5.4 V DC, 100 mA, typical life span: approx 10 years		
<b>Protection</b>	IP68		IP65
<b>Process Adaption</b>			
<b>Material</b>	wetted parts: stainless steel 1.4435 (SS 316L) dF < 1%, BN2 surface: N5: Ra < 0.4 µm (16 µinch) - electropolished		
<b>Port connection</b>	Fermenter head plates diameter: 12 mm thread: PG 13.5	OSP25-GS60 (similar Ingold-port) nominal length: 60 and 30 mm diameter: 25 mm thread: G1-1/4 in. ISO 228/1	OSP25-GS52 (similar safety- port) nominal length: 52 and 30 mm diameter: 25 mm thread: G1-1/4 in. ISO 228/1
<b>Port gasket</b>	O-ring 11.00 x 3.00 mm EPDM (FDA / USP Class VI)	O-ring 18.64 x 3.53 mm EPDM (FDA / USP Class VI), others on request	
<b>Insertion depth</b>	110 mm + OPL 215 mm + OPL 315 mm + OPL others on request	35 mm + OPL with port length 60 mm	35 mm + OPL with port length 52 mm
<b>Process pressure</b>	pressure-free (+/- 0.5 bar) (+/- 7.25 psi)	0 - 10 bar (0 - 145 psi)	
<b>Windows</b>	Sapphire (seal-less)		
<b>Installation accessories</b>	Adapter PG 13.5 Variable depth Adapter M 26 x 1 - PG 13.5	weld-in ports, Varivent adapter (50.00), clamp adapter,	weld-in ports
<b>Temperature Ratings</b>			
<b>Process temperature</b>	permanent: 5 - 50 °C (41 - 122 °F)	permanent: 5 - 65 °C (41 - 149 °F) peak (60 min./day): 5 - 135 °C (41 - 275 °F) thermal shutdown at approximately 75 °C (167 °F)	
<b>Ambient temperature</b>	operation: 0 - 40 °C (32 - 104 °F) transport: -20 - 70 °C (-4 - 158 °F)		
<b>Sterilization conditions</b>	Sterilization must be performed outside the process and the ASD must be discon- nected from the power source (autoclaving possible without cable) max. pressure: 4 bar (58 psi) max. temperature: 135 °C (275 °F) (max. 60 min./day)	Autoclaving not possible	

Pressure and temperature ratings specified herein may be subject to limitations - see instruction manual.  
The appropriate choice of material for all wetted parts is the sole responsibility of the user.  
Data given are subject to changes without prior notice.



optek ASD25-N  
Single Channel Absorption Probe



optek ASD25-BT-N  
Single Channel Absorption Probe

## 22 | Conductivity Sensors ACF60 / ACS60



- Six-electrode design reduces sensitivity to fouling and polarization
- Wide measuring range:  
0 - 10  $\mu\text{S}/\text{cm}$  up to 0 - 850  $\text{mS}/\text{cm}$
- Integrated Pt1000 temperature sensor
- No O-rings or epoxy - suitable for CIP/SIP

### Six-Electrodes

The ACF60/ACS60 conductivity sensor features a superior six-electrode, four-pole design. The arrangement of the four current electrodes around the two potential electrodes results in a reliable and precise measurement. This unique design also provides greatly reduced sensitivity to sensor fouling and polarization. The combination of optek C82x or C8000 universal converter and ACF60/ACS60 conductivity sensors allow a wide dynamic range from 0 - 10  $\mu\text{S}/\text{cm}$  up to 0 - 850  $\text{mS}/\text{cm}$  with the same sensor.

### Temperature Measurement

The integrated Pt1000 platinum RTD in the tip of the ACF60/ACS60 sensor provides fast-response temperature measurement for compensation, which can be displayed and transmitted from the C8000 converter.

### Sanitary Design

Designed for ultra-sterility, the six electrodes are sealed in the FDA (USP class VI) compliant PEEK sensor tip without the use of O-rings or epoxy. The ACF60/ACS60 sensor is suitable for CIP/SIP applications.

### ACF60

Mounted in an optek inline sensor body, the design ensures smooth and unrestricted flow of all process fluids with minimized hold-up and hydrostatic shear.



ACF60  
Conductivity Sensor



ACS60  
Conductivity Sensor

Technical Data	ACF60	ACS60
<b>Material (wetted)</b>	PEEK (FDA, USP Class VI) electrodes: • Stainless Steel 1.4435 (SS 316L), dF < 1%, BN2 • Hastelloy 2.4602 Hastelloy C22	
<b>Port-gaskets</b>	O-ring: EPDM (FDA, USP Class VI), ... others on request	
<b>Line size</b>	1/8 in. to 6 in. (DN 6 to DN 150), ... others on request	
<b>Port connection</b>		OSP25-GS60 (similar Ingold-port) nominal length: 60 mm diameter: 25 mm thread: G1-1/4 in. ISO 228/1
<b>Installation accessories</b>		weld-in ports, Varivent adapter 50.00), clamp adapter
<b>Process pressure</b>	0 - 20 bar (0 - 290 psi) - 50 °C (122 °F) 0 - 10 bar (0 - 145 psi) - 100 °C (212 °F) 0 - 4 bar (0 - 58 psi) - 135 °C (275 °F)	
<b>Process temperature</b>	permanent: -10 - 90 °C (14 - 194 °F) peak 30 min/day: -10 - 135 °C (14 - 275 °F)	
<b>Ambient temperature</b>	operation: -10 °C - 40 °C (14 °F - 104 °F) transport: -20 °C - 70 °C (-4 °F - 158 °F)	
<b>Temperature sensor</b>	integrated Pt1000 RTD (IEC Class A) accuracy: $\pm 0.25$ °C at 25 °C (77 °F)	
<b>Protection</b>	IP65	
<b>Measuring range</b>	any measuring range between 0 - 10 $\mu\text{S}/\text{cm}$ to 850 $\text{mS}/\text{cm}$	

	Accuracy	Repeatability
0 - 10 $\mu\text{S}/\text{cm}$	calibrated: $\pm 1\%$ of measuring value $\pm 0.2$ $\mu\text{S}/\text{cm}$ uncalibrated: $\pm 3\%$ of measuring value $\pm 0.2$ $\mu\text{S}/\text{cm}$	$\pm 0.5\%$
0 - 250 $\text{mS}/\text{cm}$	calibrated: $\pm 1\%$ of measuring value $\pm 0.2$ $\mu\text{S}/\text{cm}$ uncalibrated: $\pm 3\%$ of measuring value $\pm 0.2$ $\mu\text{S}/\text{cm}$	$\pm 0.5\%$
250 - 500 $\text{mS}/\text{cm}$	calibrated: $\pm 2\%$ of measuring value $\pm 0.2$ $\mu\text{S}/\text{cm}$ uncalibrated: $\pm 6\%$ of measuring value $\pm 0.2$ $\mu\text{S}/\text{cm}$	$\pm 1\%$
500 - 850 $\text{mS}/\text{cm}$	calibrated: $\pm 5\%$ of measuring value $\pm 0.2$ $\mu\text{S}/\text{cm}$ uncalibrated: $\pm 12\%$ of measuring value $\pm 0.2$ $\mu\text{S}/\text{cm}$	$\pm 3\%$

Pressure and temperature ratings specified herein may be subject to limitations - see instruction manual. The appropriate choice of material for all wetted parts is the sole responsibility of the user. Data given are subject to changes without prior notice.



- 12-degree electrode orientation provides improved performance
- pH electrode solution ground allows inline diagnostics
- Designed to enhance flow and minimize hold-up volume
- Suitable for most Ø 12 x 120 mm pH-electrodes

## 12 Degree

The optek PF12 pH electrode adapter is designed to mount pH electrodes at the optimal angle of 12 degrees. This allows the sensor to use electrolyte-filled glass electrodes and improves the functionality and life span of the pH electrodes. The PF12 electrode adapter is compatible with a broad variety of pH electrodes.

## Solution Ground

The PF12 is equipped with a solution ground (earth) connection mounted to the sensor body. This allows the use of pH electrodes that incorporate differential pH input techniques. Additionally, the solution earth connection provides a highly stable measurement while enabling sensor diagnostics including low glass impedance, out-of sample, and broken electrode/cable warnings.

## Sanitary Design

Mounted in an optek inline sensor body, the design of the PF12 ensures smooth and unrestricted flow of all process fluids. The PF12 meets sterility requirements and is compatible with CIP/SIP while minimizing hold-up volume and hydrostatic shear.



PF12  
pH Electrode Holder



ACF60

PF12

Technical Data	PF12
<b>Material</b>	Stainless steel 1.4435 (SS 316L), dF < 1%, BN2
<b>Material (wetted)</b>	<ul style="list-style-type: none"> <li>• Stainless Steel 1.4435 (SS 316L), dF &lt; 1%, BN2 or</li> <li>• Hastelloy 2.4602 Hastelloy C22</li> </ul>
<b>Surface</b>	N5: Ra < 0.4 µm (16 µinch) - electropolished
<b>Solution ground</b>	female SA483 for solution ground plug
<b>Line size</b>	1/8 in. to 6 in. (DN 6 to DN 150), ... others on request
<b>Electrode types</b>	suitable for wide variety of electrodes with dimensions Ø 12 x 120 mm, PG 13.5 thread
<b>Process temperature</b>	-10 °C - 135 °C (14 °F - 275 °F)
<b>Process pressure</b>	0 - 6 bar (0 - 87 psi)

### pH and conductivity measurement combined for low hold-up volume\*

Line Size	Volume	Volume
	cond. only	pH + cond.
0.25 in.	< 41 ml	< 38 ml
0.50 in.	< 44 ml	< 41 ml
0.75 in.	< 52 ml	< 49 ml
1.00 in.	< 64 ml	< 61 ml

\* Example values for hold-up volume of an optek F40 sensor body with process connection according to DIN32676-series C, electrode adapter PF12.0-86 and pH electrode with Ø 12 x 120 mm.

Pressure and temperature ratings specified herein may be subject to limitations - see instruction manual. The appropriate choice of material for all wetted parts is the sole responsibility of the user. Data given are subject to changes without prior notice.

## 24 | Single Use Cell (S.U.C.)



- No contamination risk
- No cleaning or validation
- OPL correction value for maximum accuracy
- Up to 6 parallel measurements
- USP Class VI and FDA approval

The Single Use Cell (S.U.C.) is designed to optimize separation, purification, concentration and formulation processes in disposable downstream systems. Cross-contamination between products and batches will no longer be an issue as gamma irradiated Single Use Cells decrease the risk of contamination to virtually zero.

### S.U.C. Design

The S.U.C. is available in five different designs. Each S.U.C. is clearly labeled with data specific to that particular cell. This data includes the sensor constant of the conductivity sensor (except SUC24) as well as the OPL (optical path length) adaptation data for SUC24, SUC25 and SUC27.

### SUC Holder

Integral parts of the S.U.C. system include the holder and locking mechanism guaranteeing proper installation. To enable easy and fast installation into the process instrumentation, the S.U.C. holder comes equipped with the conductivity sensor ACF60-SU-35.

### SUC Holder OPT





For the SUC24, which is designed for only optical measurements there is a separate holder, the SUC Holder OPT. All SUC Holders are fully compatible with optek UV, NIR and VIS sensors.

### S.U.C. pH Adapter

SUC23 and SUC27 are equipped with the pH adapter, which is compatible with a broad variety of standard pH electrodes (Ø12 mm x 120 mm). When no pH adapter is required (for SUC21 and SUC25) a plug is used to cover the pH input. This pH plug has the same dimensions as the pH electrode, keeping the hold-up volume minimal.

### S.U.C. (Single Use Cells)

- With low hold-up volumes and easy installation they are fully compatible with the optek range of UV, NIR and color absorption sensors
- The Single Use Cells are manufactured in a clean room facility and are gamma irradiation ready
- Simple fast exchange of the S.U.C. eliminates the need for system cleaning and validation
- Improved productivity due to simpler exchange procedures and low down time between products / batches.

Available Models					
S.U.C. Types	Conductivity	pH	Optical	Hold-up Volume	Example
SUC21	✓	—	—	20 ml	
SUC23	✓	✓	—	20 ml	
SUC24	—	—	✓	(OPL 1 mm): 9.2 ml (OPL 2.5 mm): 9.7 ml (OPL 10 mm): 12 ml (OPL 20 mm): 15 ml	
SUC25	✓	—	✓	(OPL 1 mm): 22 ml (OPL 2.5 mm): 23 ml (OPL 10 mm): 25 ml (OPL 20 mm): 28 ml	
SUC27	✓	✓	✓	(OPL 1 mm): 22 ml (OPL 2.5 mm): 23 ml (OPL 10 mm): 25 ml (OPL 20 mm): 28 ml	

Technical Data	SUC Holder Including ACF60-SU-35	SUC Holder OPT
Material (non wetted)	SS 316L	
Measuring range	0 µS/cm to 150 mS/cm Accuracy: ± 2% of measuring value ± 0.4 µS/cm (dependent on ambient and process temperature being equal)	N/A
Temperature compensation of conductivity sensor	Accuracy ≤ 0.8% of measuring value at temperature conditions (T ambient - T process) ≤ ± 20 °C (± 68 °F)	N/A
Protection	IP65	
Cleanability	Cleaning with standard cleaning agents (alcoholic surface disinfectants, quaternary ammonium compounds) is permitted.	
	Caution! Ensure that windows are clean and dry and the contact unit for the electrodes is dry before starting measurement.	Caution! Ensure that windows are clean and dry before starting measurement.
Technical Data	SUC21 / SUC23 / SUC25 / SUC27	SUC24
Material (wetted)	Conductivity electrode pins: stainless steel 1.4435 (SS 316L), dF < 1%, BN2	N/A
	Windows (SUC24, SUC25, SUC27): Quartz , UV transparent Gasket: EPDM (FDA, USP class VI) Sensor body: Polyphenylsulfone (PPSU)  The plastic and elastomeric wetted parts of the sensor have passed the bio-reactivity tests according to USP <87> and <88> class VI and comply with FDA Regulations 21 CFR 177.2600. All wetted parts are of non-animal origin and any materials of animal origin or containing animal substances are not used during manufacture. All wetted parts are of bovine-free origin and any materials of bovine origin or containing TSE have not been used during manufacture.	
Surface (wetted parts)	N6: Ra < 0.8 µm (32 µinch)	
Process connection	Hose barb, Clamp <sup>1)</sup>	
Line size	Line size Hose barb 0.25 in., 0.375 in., 0.5 in., 0.625 in., 0.75 in., 1 in. Line size - Clamp Mini-TC <sup>1,2)</sup> 0.25 in., 0.375 in., 0.5 in., 0.625 in. Line size - Clamp TC <sup>1,3)</sup> 0.75 in., 1 in.	
Optical Path Length (OPL) <sup>4)</sup>	1 mm, 2.5 mm, 10 mm, 20 mm	
Shelf life	36 months after manufacturing date, under appropriate climatic conditions <sup>5)</sup>	
Permitted gamma irradiation	Tested to 55 kGy	
Temperature and Pressure Ratings		
Process pressure	0 - 6 bar (0 - 87 psi) May be reduced in combination with pH probe. Refer to corresponding instruction manual for specifications of pH probe	0 - 6 bar (0 - 87 psi)
Process temperature	2 - 50 °C (35.6 - 122 °F) May be reduced in combination with pH probe. Refer to corresponding instruction manual for specifications of pH probe	2 - 50 °C (35.6 - 122 °F)
Transport temperature	-20 - 60 °C (-4 - 140 °F), max. 10 days	
Storage conditions	Temperature: 15 - 25 °C (59 - 77 °F). Relative humidity: max. 60% No exposure to fumes.	
Ambient conditions	Temperature during operation: 2 - 30 °C (35.6 - 86 °F) Relative humidity 80% for temperature up to 31 °C (87 °F)	

Data given are subject to changes without prior notice.

<sup>1)</sup> Clamps according to ASME BPE Design Standard 2016, Table DT-7-1, IMPORTANT: Deviating from the ASME BPE design standard, the line size of the S.U.C. clamp is referring to the internal diameter or bore, NOT the external tube diameter.

<sup>2)</sup> Flange Type A, Diameter 0.984 in., "Mini-TC". Note: SUC Holder Spacer necessary!

<sup>3)</sup> Flange Type B, Diameter 1.984 in., "TC". Note: SUC Holder Spacer necessary!

<sup>4)</sup> Valid only for SUC24, SUC25 and SUC27

<sup>5)</sup> See: Storage conditions

Assembly of a SUC27

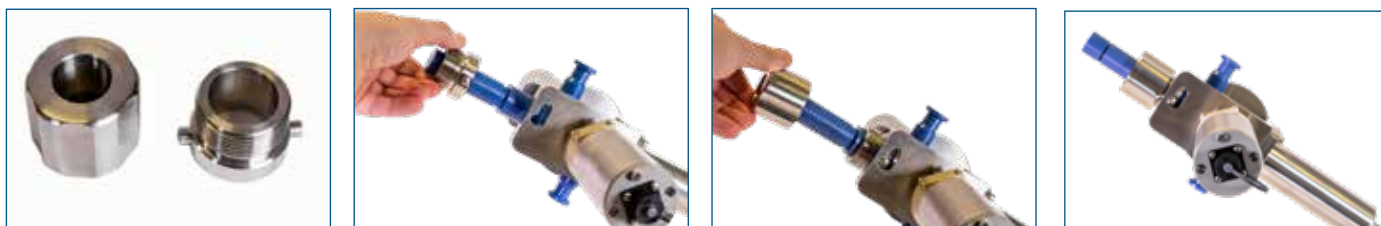



## 26 | Sensor Body (Armature)

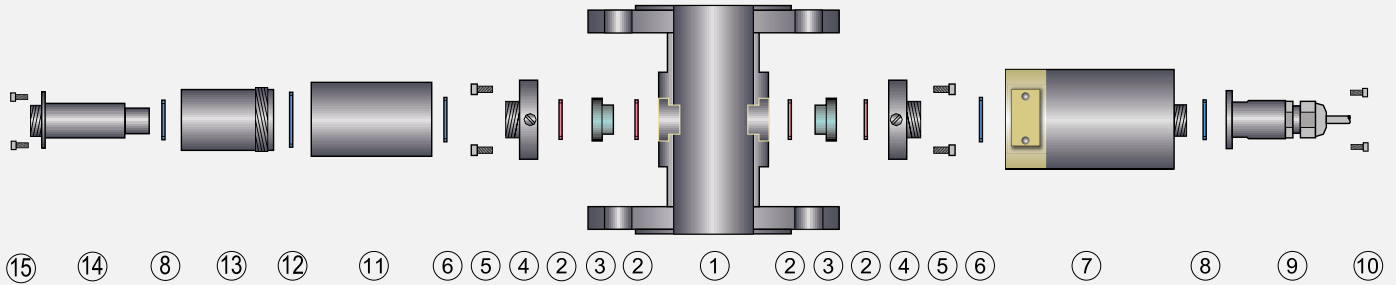

### Example Exploded View - Model AF26-VB:

- 1 Sensor body 1/8 in. to 6 in. (DN 6 to DN 150)
- 2 O-rings (EPDM, Viton®, Kalrez® etc.)
- 3 Windows (Sapphire, Pyrex®)
- 4 Window ring M24 (1.4571 / 316 Ti)
- 5 8 Screws (M5 x 12) with lock washer
- 6 O-ring (Viton®)
- 7 Detector assembly AF26-HT-VB
- 8 O-ring (EPDM, Viton®, Kalrez® etc.)
- 9 SS-plug protection
- 10 4 Screws (M3 x 6)
- 11 Lamp adapter AF26 incl. optics module AF
- 12 O-ring 31.47 x 1.78 mm
- 13 Optical housing OH06
- 14 Lamp module AF26
- 15 4 Screws (M3 x 6)

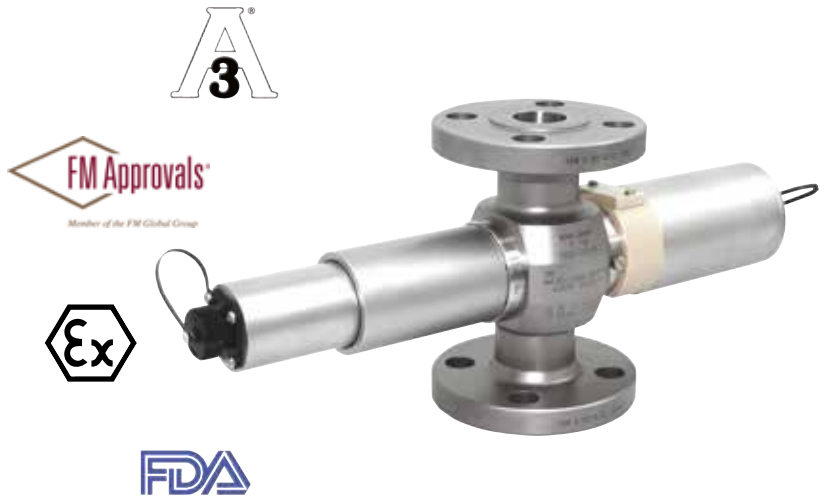

Sensor Body	
For Variations and Details see Separate Sensor Body Datasheet	
<b>Material</b>	Stainless steel 1.4435 (SS 316L), 1.4539 (904 L), 1.4571 (SS 316Ti), 1.4462 (318 LN), Titanium 3.7035 (Grade 2), Hastelloy 2.4602 (C22), Plastic TFM™ 4215 ... others on request
<b>Line size</b>	1/8 in. to 6 in. (DN 6 to DN 150), ... others on request
<b>Process connection</b>	Flanges (ASME, DIN, EN, JIS), Clamps (TC, ISO, DIN), Female Threads (NPT, DIN), Sanitary Threads (DIN 11851), Tube Ends (DIN, ISO, OD), DIN 11864-1/-2/-3 (DIN, ISO, OD), Varivent (DIN, IPS, OD), ... others on request
<b>Process pressure</b>	0 - 100 bar (0 - 1450 psi) - higher on request depending on process connection, materials and design
<b>Windows</b>	1-Pyrex®, 2-Sapphire, 3-Sapphire Biotech
<b>Window gaskets</b>	Silicone (FDA), Viton® (FDA), EPDM / Kalrez® 6230 (FDA / USP Class VI), Kalrez® 4079 ... others on request



Windows available in different lengths for OPL (optical path length) adjustment



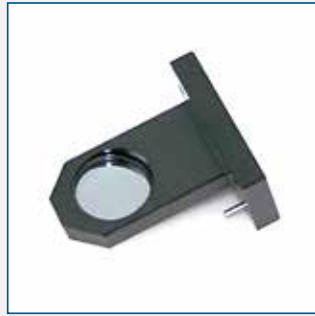

optek calibration accessories are specifically designed for nonintrusive calibration and verification of optek systems.

### UV Sensors

Three series of solid filters are available to ensure confidence in measurements. The UV-L filter series is used to calibrate photometric accuracy and linearity. The UV-B filter series verifies integral blocking and the UV-S filter series tests for long-term stability of the sensor.

### VIS/NIR Sensors

A special series of solid filters is available for each wavelength (range) to ensure best measurement performance. The calibration filters are used to calibrate photometric accuracy and linearity.

### NIST-Traceable

All optek UV/VIS filters ship with NIST-traceable (National Institute of Standards and Technology) certification. The optek laboratory is equipped with a high quality, NIST-traceable spectrophotometer to assure quality and quick turnaround time for recertification of filters.

### Concept

Advantages of optek calibration concept include:

- Only 1 filter (set) for multiple sensors ensures identical calibration
- Only the filter needs to be sent back for recertification, while the sensor remains operating

- **Calibration Filters UV-L**

Nominal absorption: 0.45, 0.9, 1.8 and 2.4 CU\*

- **Calibration Filter UV-B**

Nominal absorption: > 3 CU\*

- **Calibration Filters UV-S**

Nominal absorption: Application specific

- **Calibration Filters VIS-L**

Nominal absorption: 0.45, 0.9 and 1.8 CU\*

- **Calibration Filters NIR-L**

Nominal absorption: 0.45, 0.9 and 1.8 CU\*

\*CU = Concentration Units

- **Calibration Case**

Holds up to 7 calibration filters

- **Calibration Cuvette**

The unique calibration cuvette, FH03, enables product calibration without need to interfere with the process line.

The cuvette allows users to create a correlation of absorption signals to the concentration of product or an equivalent substance, creating an easy link from lab to process.



Calibration cuvette FH03

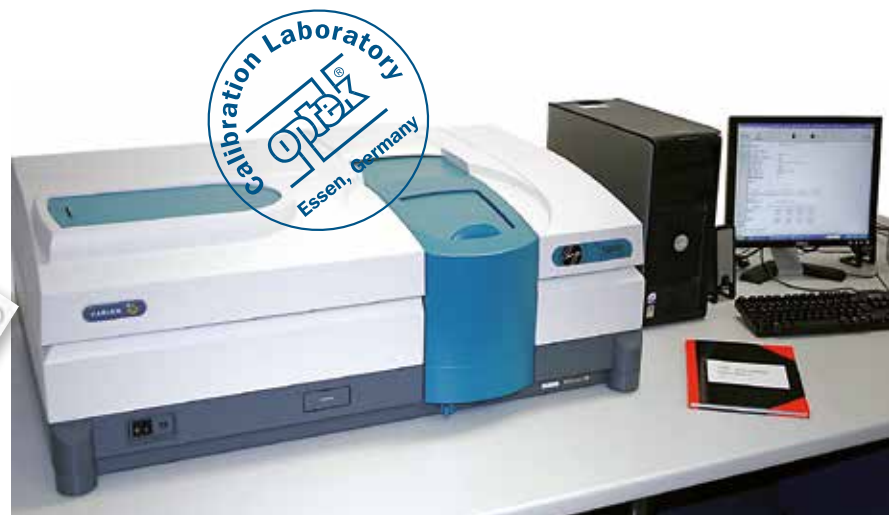



## **Germany**

optek-Danulat GmbH  
Emscherbruchallee 2  
45356 Essen / Germany  
Phone: +49 201 63409 0  
E-Mail: info@optek.de

## **USA**

optek-Danulat Inc.  
N118 W18748 Bunsen Drive  
Germantown WI 53022 / USA  
Phone: +1 262 437 3600  
Toll free call: +1 800 371 4288  
E-Mail: info@optek.com

## **Singapore**

optek-Danulat Pte. Ltd.  
25 Int'l Business Park  
#02-09 German Centre  
Singapore 609916  
Phone: +65 6562 8292  
E-Mail: info@optek.com.sg

## **China**

optek-Danulat Shanghai Co., Ltd.  
Room 718 Building 1  
No.88 Keyuan Road  
Pudong Zhangjiang  
Shanghai, China 201203  
Phone: +86 21 2898 6326  
E-Mail: info@optek-danulat.com.cn

## **中国**

优培德在线测量设备（上海）  
有限公司  
上海张江科苑路88  
号德国中心718  
室 邮编: 201203  
电话: +86-21-28986326  
E-Mail: info@optek-danulat.com.cn

Please visit our website for contact details of our local distributors in other countries.  
[www.optek.com](http://www.optek.com)