

LMK 382H

Stainless Steel Probe with HART®-communication

Ceramic Sensor

accuracy according to IEC 60770:
0.1 % FSO



Nominal pressure

from 0 ... 60 cmH₂O up to 0 ... 200 mH₂O

Output signals

2-wire: 4 ... 20 mA
others on request

Special characteristics

- ▶ diameter 39.5 mm
- ▶ HART® communication (setting of offset, span and damping)
- ▶ permissible temperatures up to 85 °C
- ▶ high overpressure resistance
- ▶ high long-term stability

Optional versions

- ▶ IS-version
Ex ia = intrinsically safe for gas and dust
- ▶ mounting with stainless steel pipe
- ▶ flange version
- ▶ diaphragm 99.9 % Al₂O₃
- ▶ accessories e.g. transmitter and mounting flanges and terminal clamp

The stainless steel probe LMK 382H has been designed for continuous level measurement in sewage, polluted and higher viscosity fluids.

Basic element is a robust and high overpressure capable capacitive ceramic sensor e.g. for low levels.

Preferred areas of use are

 Water
ground water level measurement
rain spillway basins

 Sewage
waste water treatment
water recycling

 Fuel and oil
level monitoring in open tanks
with low filling heights
fuel storage
tank farms
biogas plants



Pressure ranges ¹										
Nominal pressure	[bar]	0.06	0.16	0.4	1	2	5	10	20	
Level	[mH ₂ O]	0.6	1.6	4	10	20	50	100	200	
Overpressure	[bar]	2	4	6	8	15	25	35	45	
Max. ambient pressure (housing): 40 bar										
¹ on customer request we adjust the devices by software on the required pressure ranges, within the turn-down possibility (starting at 0.02 bar)										
Output signal / Supply										
Standard	2-wire: 4 ... 20 mA / V _S = 12 ... 36 V _{DC} with HART® communication							V _{S rated} = 24 V _{DC}		
Option IS-version	2-wire: 4 ... 20 mA / V _S = 14 ... 28 V _{DC} with HART® communication							V _{S rated} = 24 V _{DC}		
Performance										
Accuracy ²	p _N ≥ 160 mbar	TD ≤ 1:5 ≤ ± 0.2 % FSO					TD > 1:5 ≤ ± [0.2 + 0.03 x TD] % FSO		TD _{max} = 1:10	
	p _N < 160 mbar	≤ ± [0.2 + 0.1 x TD] % FSO							TD _{max} = 1:3	
	p _N ≥ 1 bar	TD ≤ 1:5 ≤ ± 0.1 % FSO					TD > 1:5 ≤ ± [0.1 + 0.02 x TD] % FSO		TD _{max} = 1:10	
Permissible load	R _{max} = [(V _S - V _{S min}) / 0.02 A] Ω					load at HART®-communication: R _{min} = 250 Ω				
Long term stability	≤ ± (0.1 x turn-down) % FSO / year at reference conditions									
Influence effects	supply: 0.05 % FSO / 10 V					permissible load: 0.05 % FSO / kΩ				
Turn-on time	850 msec									
Mean response time	140 msec without consideration of electronic damping						mean measuring rate 7/sec			
Max. response time	380 msec									
Adjustability	configuration of following parameters possible (interface / software necessary ³):									
	- electronic damping: 0 ... 100 sec									
	- offset: 0 ... 80 % FSO									
	- turn down of span: max. 1:10									
² accuracy according to IEC 60770 – limit point adjustment (non-linearity, hysteresis, repeatability)										
³ software, interface, and cable have to be ordered separately (software appropriate for Windows® 95, 98, 2000, NT Version 4.0 or higher, and XP)										
Thermal effects (offset and span)										
Tolerance band	≤ ± 1 % FSO									
in compensated range	-20 ... 80 °C									
Permissible temperatures										
Permissible temperatures	medium / electronics / environment / storage: -25 ... 85 °C									
Electrical protection ⁴										
Short-circuit protection	permanent									
Reverse polarity protection	no damage, but also no function									
Electromagnetic compatibility	emission and immunity according to EN 61326									
⁴ additional external overvoltage protection unit in terminal box KL 1 or KL 2 with atmospheric pressure reference available on request										
Mechanical stability										
Vibration	4 g (according to: DIN EN 60068-2-6)									
Electrical connection										
Cable outlet with sheath material ⁵	PVC (-5 ... 70 °C)	grey	Ø 7.4 mm							
	PUR (-25 ... 70 °C)	black	Ø 7.4 mm							
	FEP ⁶ (-25 ... 70 °C)	black	Ø 7.4 mm							
	TPE-U (-25 ... 85 °C)	blue	Ø 7.4 mm							
Bending radius	static installation:		10-fold cable diameter							
	dynamic application:		20-fold cable diameter							
⁵ shielded cable with integrated ventilation tube for atmospheric pressure reference										
⁶ do not use freely suspended probes with an FEP cable if effects due to highly charging processes are expected										
Materials										
Housing	stainless steel 1.4404 (316 L)									
Seals	FKM, FFKM, EPDM, others on request									
Diaphragm	standard: ceramics Al ₂ O ₃ 96 % option: ceramics Al ₂ O ₃ 99.9 %									
Protection cap	POM-C									
Cable sheath	PVC, PUR, FEP, TPE-U, others on request									
Explosion protection										
Approval DX15A-LMK 382H	IBExU 10 ATEX 1186 X zone 0 ⁷ : II 1G Ex ia IIB T4 Ga zone 20: II 1D Ex ia IIIC T135 °C Da									
Safety technical maximum values	U _i = 28 V, I _i = 93 mA, P _i = 660 mW, C _i = 13.2 nF, L _i = 0 μH, the supply connections have an inner capacity of max. 27 nF opposite the enclosure									
Permissible media temperature	in zone 0: -10 ... 60 °C with p _{atm} 0.8 bar up to 1.1 bar zone 1 or higher: -25 ... 70 °C									
Connecting cables (by factory)	cable capacitance: signal line/shield also signal line/signal line: 160 pF/m cable inductance: signal line/shield also signal line/signal line: 1 μH/m									
⁷ for optional stainless steel pipe following designation is valid: "II 1G Ex ia IIC T4" (zone 0)										

LMK 382H

Stainless Steel Probe

Technical Data

Miscellaneous	
Option cable protection for probes	prepared for mounting with stainless steel pipe
Ingress protection	IP 68
Current consumption	max. 21 mA
Weight	approx. 400 g (without cable)
CE-conformity	EMC Directive: 2014/30/EU
ATEX Directive	2014/34/EU

Wiring diagram

2-wire-system (current) HART®

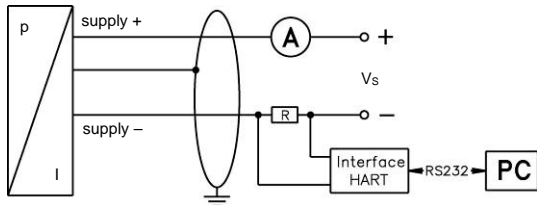

Pin configuration

Electrical connection	cable colours (IEC 60757)
Supply +	WH (white)
Supply -	BN (brown)
Shield	GNYE (green-yellow)

Dimensions (mm / in)

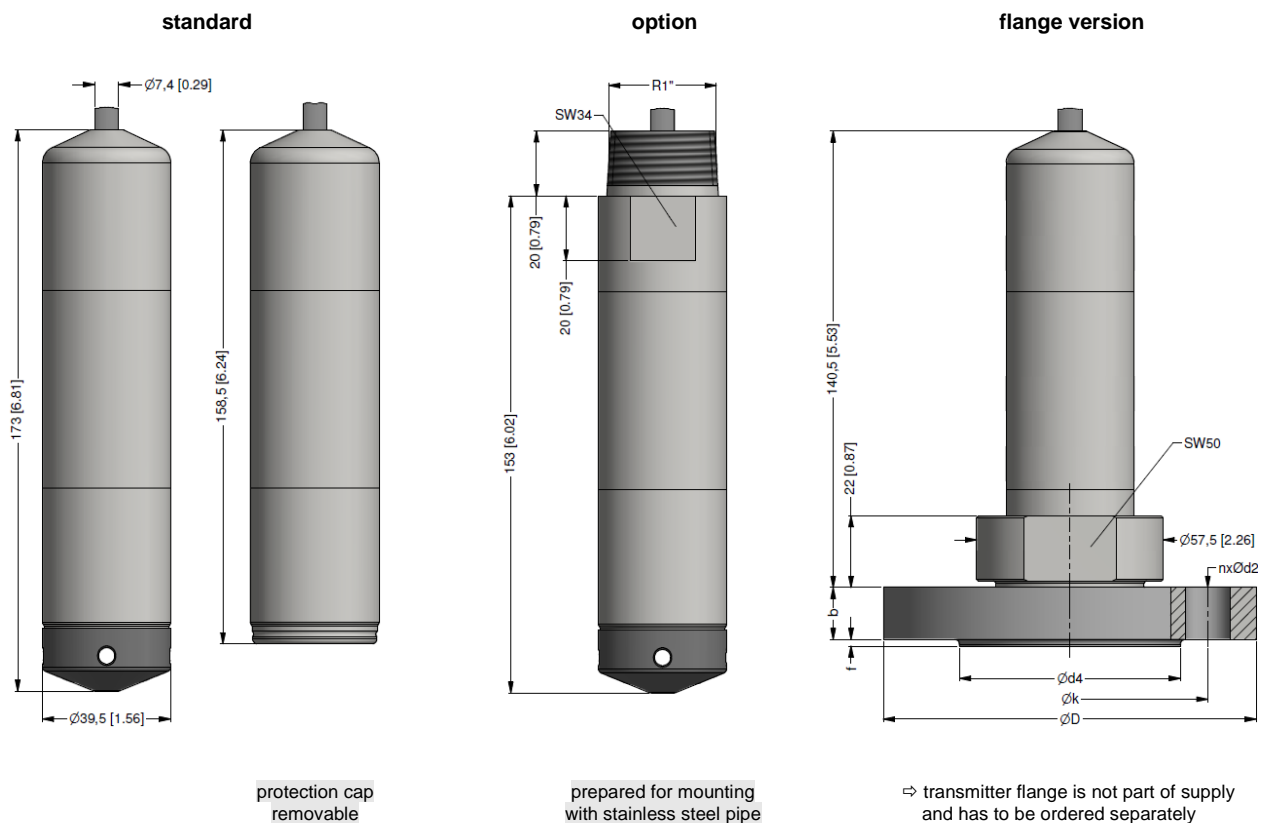

HART® is a registered trade mark of HART Communication Foundation; Windows® is a registered trade mark of Microsoft Corporation

Transmitter flange for flange version

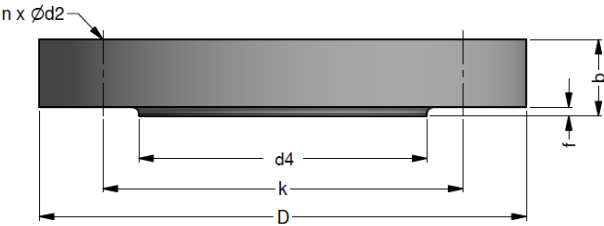

dimensions in mm			
size	DN25 / PN40	DN50 / PN40	DN80 / PN16
b	18	20	20
D	115	165	200
d2	14	18	18
d4	68	102	138
f	2	3	3
k	85	125	160
n	4	4	8

Technical data		
Suitable for	LMK 382, LMK 382H, LMK 458, LMK 458H	
Flange material	stainless steel 1.4404 (316L)	
Hole pattern	according to DIN 2507	
Ordering type	Ordering code	Weight
Transmitter flange DN25 / PN40	ZSF2540	1.2 kg
Transmitter flange DN50 / PN40	ZSF5040	2.6 kg
Transmitter flange DN80 / PN16	ZSF8016	4.1 kg

Mounting flange with cable gland

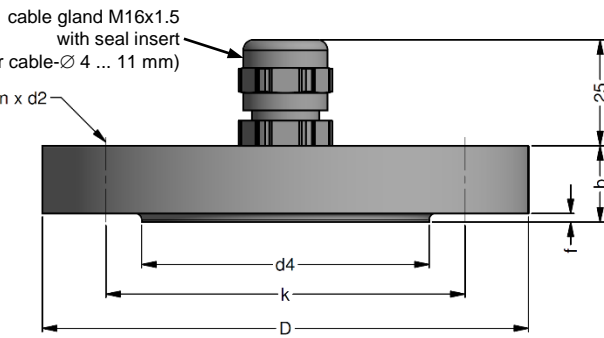

dimensions in mm			
size	DN25 / PN40	DN50 / PN40	DN80 / PN16
b	18	20	20
D	115	165	200
d2	14	18	18
d4	68	102	138
f	2	3	3
k	85	125	160
n	4	4	8

Technical data		
Suitable for	all probes	
Flange material	stainless steel 1.4404 (316L)	
Material of cable gland	standard: brass, nickel plated on request: stainless steel 1.4305 (303); plastic	
Seal insert	material: TPE (ingress protection IP 68)	
Hole pattern	according to DIN 2507	
Ordering type	Ordering code	Weight
DN25 / PN40 with cable gland brass, nickel plated	ZMF2540	1.4 kg
DN50 / PN40 with cable gland brass, nickel plated	ZMF5040	3.2 kg
DN80 / PN16 with cable gland brass, nickel plated	ZMF8016	4.8 kg

Terminal clamp



Technical data		
Suitable for	all probes with cable Ø 5.5 ... 10.5 mm	
Material of housing	standard: steel, zinc plated optionally: stainless steel 1.4301 (304)	
Material of clamping jaws and positioning clips	PA (fibre-glass reinforced)	
Dimensions (mm)	174 x 45 x 32	
Hook diameter	20 mm	
Ordering type	Ordering code	Weight
Terminal clamp, steel, zinc plated	Z100528	approx. 160 g
Terminal clamp, stainless steel 1.4301 (304)	Z100527	

© 2022 BD|SENSORS GmbH – The specifications given in this document represent the state of engineering at the time of publishing. We reserve the right to make modifications to the specifications and materials.

Ordering code LMK 382H

LMK 382H



Pressure										
	in bar	5	6	5						
	in mH ₂ O	5	6	6						
Input										
	[mH ₂ O]									
	[bar]									
	0.6	0.06	0	6	0	0				
	1.6	0.16	1	6	0	0				
	4.0	0.40	4	0	0	0				
	10	1.0	1	0	0	1				
	20	2.0	2	0	0	1				
	50	5.0	5	0	0	1				
	100	10	1	0	0	2				
	200	20	2	0	0	2				
	customer		9	9	9				consult	
Housing										
	stainless steel 1.4404 (316L)					1				
	customer					9			consult	
Diaphragm										
	ceramics Al ₂ O ₃ 96 %					2				
	ceramics Al ₂ O ₃ 99.9 %					C				
	customer					9			consult	
Output										
	HART [®] -communication						H			
	4 ... 20 mA / 2-wire									
	HART [®] -communication						I			
	intrinsic safety 4 ... 20 mA / 2-wire									
	customer						9		consult	
Seals										
	FKM					1				
	EPDM					3				
	FFKM					7				
	customer					9			consult	
Electrical connection										
	PVC-cable (grey, Ø 7.4 mm) ¹						1			
	PUR-cable (black, Ø 7.4 mm) ¹						2			
	FEP-cable (black, Ø 7.4 mm) ¹						3			
	TPE-U-cable (blue, Ø 7.4 mm) ¹						4			
	customer						9		consult	
Accuracy										
	p _N ≥ 1 bar:	0.1 % FSO					1			
	p _N < 1 bar:	0.2 % FSO					B			
	customer						9		consult	
Cable length										
	in m							9	9	9
Special version										
	standard							0	0	0
	prepared for mounting									
	with stainless steel pipe ²							5	0	2
	flange version ³							5	1	0
	customer							9	9	9

¹ shielded cable with integrated ventilation tube for atmospheric pressure reference

² stainless steel pipe is not part of the supply

³ mounting accessories are not part of supply and have to be ordered separately

HART[®] is a registered trade mark of HART Communication Foundation