Instruction Manual

Model FU24
pH/ORP Combination sensor
with pressure compensation



(BG)

Всички улътвания за продукти от серията ATEX Ex се предлагат на английски език. Ако се нуждаете от улътвания за продукти от серията Ex на родния ви език, се свържете с най-близкия офис или представителство на фирма Yokogawa.

(CZ)

Všechny uživatelské příručky pro výrobky, na něž se vztahuje nevýbušné schválení ATEX Ex, jsou dostupné v angličtině. Požadujete-li pokyny týkající se výrobků s nevýbušným schválením ve vašem lokálním jazyku, kontaktujte prosím vaši nejbližší reprezentační kancelář Yokogawa.

(D)

Alle Betriebsanleitungen für ATEX Ex bezogene Produkte stehen in den Sprachen Englisch. Sollten Sie die Betriebs- anleitungen für Ex-Produkte in Ihrer Landessprache benötigen, setzen Sie sich bitte mit Ihrem örtlichem Yokogawa-Vertreter in Verbindung.

(DK)

Alle brugervejledninger for produkter relateret til CE er tilgængelige på engelsk. Skulle De ønske yderligere oplysninger om håndtering af CE produkter på eget sprog, kan De rette henvendelse herom til den nærmeste Yokogawa afdeling eller forhandler.

(EST)

Kõik ATEX Ex toodete kasutamishendid on esitatud inglise keeles. Ex seadmete muukeelse dokumentatsiooni saamiseks pöörduge lähima lokagava (Yokogawa) kontori või esindaja poole.

(E)

Todos los manuales de instrucciones para los productos antiexplosivos de ATEX están disponibles en inglés. Si desea solicitar las instrucciones de estos artículos antiexplosivos en su idioma local, deberá ponerse en contacto con la oficina o el representante de Yokogawa más cercano.

(F)

Tous les manuels d'instruction des produits ATEX Ex sont disponibles en langue anglaise. Si vous nécessitez des instructions relatives aux produits Ex dans votre langue, veuillez bien contacter votre représentant Yokogawa le plus proche.

(GB)

All instruction manuals for ATEX Ex related products are available in English. Should you require Ex related instructions in your local language, you are to contact your nearest Yokogawa office or representative.

(GR)

Όλα τα εγχειρίδια λειτουργίας των προϊόντων με ATEX Ex διατίθενται στα Αγγλικά. Σε περίπτωση που χρειάζεστε οδηγίες σχετικά με Ex στην τοπική γλώσσα παρακαλούμε επικοινωνήστε με το πλησιέστερο γραφείο της Yokogawa ή αντιπροσωπο της.

(H)

Az ATEX Ex műszerek gépkönyveit angol nyelven adjuk ki. Amennyiben helyi nyelven kérik az Ex eszközök leírásait, kérjük keressék fel a legközelebbi Yokogawa irodát, vagy képviselőt.

(I)

Tutti i manuali operativi di prodotti ATEX contrassegnati con Ex sono disponibili in inglese. Se si desidera ricevere i manuali operativi di prodotti Ex in lingua locale, mettersi in contatto con l'ufficio Yokogawa più vicino o con un rappresentante.

(LV)

Visas ATEX Ex kategorijas izstrādājumu Lietošanas instrukcijas tiek piegādātas angļu valodās. Ja vēlaties saņemt Ex ierīšu dokumentāciju citā valodā, Jums ir jāsazinās ar firmas Yokogawa (Yokogawa) tuvāko ofisu vai pārstāvi.

(LT)

Visos gaminio ATEX Ex kategorijos Eksploatavimo instrukcijos teikiami anglo kalbomis. Norėdami gauti prietaisø Ex dokumentacijà kitomis kalbomis susisiekite su artimiausiu bendrovės Yokogawa biuru arba atstovu.

(M)

Il-manwali kollha ta' l-istruzzjonijiet għal prodotti marbuta ma' ATEX Ex huma disponibbli bl-Ingliż. Jekk tkun tehtieg struzzjonijiet marbuta ma' Ex fil-lingwa lokali tiegħek, għandek tikkuntattja lill-qrebb rappreżentant jew ufficiju ta' Yokogawa.

(NL)

Alle handleidingen voor producten die te maken hebben met ATEX explosiebeveiliging (Ex) zijn verkrijgbaar in het Engels. Neem, indien u aanwijzingen op het gebied van explosiebeveiliging nodig hebt in uw eigen taal, contact op met de dichtstbijzijnde vestiging van Yokogawa of met een vertegenwoordiger.

(P)

Todos os manuais de instruções referentes aos produtos Ex da ATEX estão disponíveis em Inglês. Se necessitar de instruções na sua língua relacionadas com produtos Ex, deverá entrar em contacto com a delegação mais próxima ou com um representante da Yokogawa.

(PL)

Wszystkie instrukcje obsługi dla urządzeń w wykonaniu przeciwwybuchowym Ex, zgodnych z wymaganiami ATEX, dostępne są w języku angielskim. Jeżeli wymagana jest instrukcja obsługi w Państwa lokalnym języku, prosimy o kontakt z najbliższym biurem Yokogawy.

(RO)

Toate manualele de instructiuni pentru produsele ATEX Ex sunt in limba engleza. In cazul in care doriti instructiunile in limba locala, trebuie sa contactati cel mai apropiat birou sau reprezentant Yokogawa.

(S)

Alla instruktionsböcker för ATEX Ex (explosionssäkra) produkter är tillgängliga på engelska. Om Ni behöver instruktioner för dessa explosionssäkra produkter på annat språk, skall Ni kontakta närmaste Yokogawakontor eller representant.

(SF)

Kaikkien ATEX Ex-tyyppisten tuotteiden käyttöohjeet ovat saatavilla englannin-. Mikäli tarvitsette Ex-tyyppisten tuotteiden ohjeita omalla paikallisella kielellänne, ottakaa yhteyttä lähimpään Yokogawa-toimistoon tai -edustajaan.

(SK)

Všetky návody na obsluhu pre prístroje s ATEX Ex sú k dispozícii v jazyku anglickom. V prípade potreby návodu pre Ex-prístroje vo Vašom národnom jazyku, skontaktujte prosím miestnu kanceláriu firmy Yokogawa.

(SLO)

Vsi predpisi in navodila za AEX Ex sorodni pridelki so pri roki v anglišèini. Èe so Ex sorodna navodila potrebna v vašem tukejnem jeziku, kontaktirajte vaš najbliži Yokogawa office ili predstavnika.

Contents

1. PREFACE	5
1.1 Introduction	5
1.2 Unpacking and Checking	5
1.3 Warranty and Service.....	6
1.4 Serial number.....	6
2. GENERAL SPECIFICATIONS	7
2.1 Measuring elements	7
2.2 Wetted parts.....	7
2.3 Functional specifications (at 25 °C)	7
2.4 Dynamic specifications.....	7
2.5 Operating range	7
2.6 Shipping details.....	8
2.7 Environmental conditions	8
2.8 Mechanical specifications.....	8
2.9 Regulatory standards	9
3. INSTALLATION OF FU24	21
3.1 Typical installation.....	21
3.2 Preparing the sensor for use	21
3.3 Mounting the sensor.....	21
4. DIMENSIONS	22
5. WIRING	23
6. GENERAL CALIBRATION & MAINTENANCE PROCEDURE	24
6.1 Calibration for pH measurement.....	24
6.2 Calibration for ORP and rH measurement	24
6.3 Maintenance of the FU24 sensor.....	25
7. MODEL CODES	26
8. SPARE PARTS	26
9. CHEMICAL COMPATIBILITY CHART	27

1. PREFACE

1.1 Introduction

This instruction manual provides information for the installation and use of the FU24 four-in-one wide body pH sensor, which is especially designed for harsh process applications.

The Model FU24 offers a simple and cost-effective solution for process applications with fluctuating pressure and/or temperature which normally limit the lifetime of a sensor.

By using the patented Bellow system, a strong pressure compensation mechanism is created. This ensures immediate interior pressure equalization to the outside process pressure, making the sensor virtually insensitive to process pressure variations.

A slight overpressure caused by the bellow tension prevents process fluid ingress and maintains a positive ion flow out of the sensor. Additionally, the sensor can be mounted in all angles including Upside Down.

This all-in-one sensor provides simultaneous measurement of pH, redox (ORP) and temperature if desired. The rugged PPS 40GF body is designed for easy installation via the 1" NPT threaded connections provided on both ends of the sensor.

The FU24 sensor is available in two types:

- With fixed cable, 5 and 10 meters.
- With Vario Pin connector: (VP and VS-model)

The VP and VS model can be used with an analogue analyzer in combination with universal WU10- cable or halogen free WE10- cable. Both cables are available in different lengths.

The VS model with integrated ID-chip can be used with SA11-P1 Smart Adapter, which is placed directly on top of this connector, or remotely connected using the 3 meter WE10-H-D-003-V1 cable.

1.2 Unpacking and Checking

Upon delivery, unpack the sensor carefully and inspect it to ensure it was not damaged during shipment. If damage is found, retain the original packing materials and then immediately notify the carrier and the relevant Yokogawa sales office. Make sure the Model Code and Serial Number on the sensor are the same as on the packing list. Also, check any option(s) that were ordered are included and correct

For some specific sensor information, the size of the sensor label is not big enough. For that reason and specifically for information related to the intrinsically safety compliance of FM-US and FM-Canada, a separate label is delivered. This label needs to be connected, in case of use in United States and Canada in a hazardous area, onto the sensor cable.

1.3 Warranty and Service

Yokogawa products and parts are guaranteed free from defects in workmanship and material under normal use and service for a period of (typically) 12 months from the date of shipment from the manufacturer. Individual sales organizations can deviate from the typical warranty period, and the conditions of sale relating to the original purchase order should be consulted. Damage caused by wear and tear, inadequate maintenance, corrosion, or by the effects of chemical processes are excluded from this warranty coverage. In the event of warranty claim, the defective goods should be sent (freight paid) to the Service Department of the relevant sales Organization for repair or replacement (at Yokogawa's discretion).

The following information must be included in the letter accompanying the returned goods:

- Model Code and Serial Number.
- Original Purchase Order and Date.
- Length of time in service and description of the process.
- Description of the fault and circumstances of the failure.
- Process/environmental conditions that may be related to the failure of the sensor
- Statement as to whether warranty or non-warranty service is requested.
- Complete shipping and billing instructions for return of material, plus the name and phone number of a contact person that can be reached for further information.
- Clean Statement
Returned goods that have been in contact with process fluids must be decontaminated and disinfected prior to shipment. Goods should carry a certificate to this effect, for the health and safety of our employees. Material Safety Data sheets must be included for all components of the process to which the sensor(options) have been exposed.

1.4 Serial number

The Serial number is defined by nine (9) alphanumeric characters:

X₁X₂ Production location
X₃X₄ Year/Month code
X₅X₆X₇X₈X₉ Tracking number

Example: N3P600028

Table 1: Production Year code

Year	Year code	Year	Year code
2014	P	2026	3
2015	R	2027	4
2016	S	2028	5
2017	T	2029	6
2018	U	2030	7
2019	V	2031	8
2020	W	2032	9
2021	X	2033	A
2022	Y	2034	B
2023	Z	2035	C
2024	1	2036	D
2025	2	2037	E

Table 2: Production Month code

Month	Month code
January	1
February	2
March	3
April	4
May	5
June	6
July	7
August	8
September	9
October	A
November	B
December	C

2. GENERAL SPECIFICATIONS

2.1 Measuring elements

: pH glass electrode
 : Silver/Silver chloride reference
 : Solid platinum electrode
 : Pt1000 temperature sensor.

2.2 Wetted parts

Sensor body : PPS 40GF
 Earthing pin : Solid Platinum
 Measuring sensor : G-glass
 LE glass tube : AR-glass
 O-ring : Viton
 Reference junction : Porous PTFE
 Bellow system : Viton

2.3 Functional specifications (at 25 °C)

Isothermal point : pH 7 / 3.3M KCl
 Reference system : Ag/AgCl with saturated KCl
 Glass impedance
 - Dome shape : 200 MΩ nominal
 - Flat Surface : 750 MΩ nominal
 Junction resistance : < 15 kΩ
 Liquid outlet : non-flow double junction
 Temperature element : Pt1000 to IEC 751
 Asymmetry potential : 8 ± 15 mV
 Slope : > 96 % (of theoretical value)

Note: The temperature sensor included in the FU24 is designed for process compensation and for indication. It is **NOT** designed for process temperature control.

2.4 Dynamic specifications

Response time pH : $t_{90} < 15$ sec. (for 7 to 4 pH step)
 Response time temperature
 - Dome shape : $t_{90} < 1$ min. (for 10 °C step)
 - Flat surface : $t_{90} < 4$ min. (for 10 °C step)
 Stabilization time pH : < 2 min. (for 0.02 pH deviation during 10 sec.)

2.5 Operating range

pH : 0 to 14
 ORP : -1500 to +1500 mV
 rH : 0 to 100
 Temperature
 - Dome shape : -10 to +105 °C (14 to 221 °F)
 - Flat Surface : +15 to +105 °C (59 to 221 °F)
 Pressure : See Graph 1
 Conductivity : > 10 μS/cm

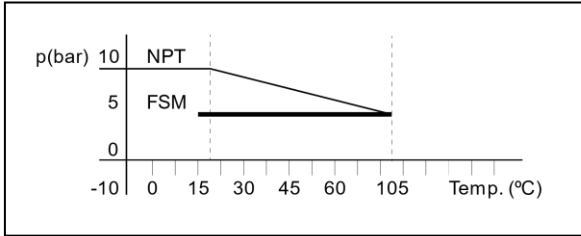

Graph 1: Pressure & Temperature range FU24

Note: The pH operating range at room temperature is 0-14 pH, but at high temperatures or range outside 2-12 pH the lifetime will be seriously shortened.

Note: The upper process temperature for the intrinsically safe version is limited by the ambient temperature ($T_{amb.}$) defined for each temperature class (T3, T4, T5 and T6)

2.6 Shipping details

	FU24-05/10	FU24-VP/VS
Package size (LxWxH)	410 x 130 x 75 mm 16.1 x 5.1 x 3.0 inch	300 x 100 x 75 mm 11.8 x 3.9 x 3.0 inch
Package weight (max.)	0.92 kg (2.02 lbs)	0.33 kg (0.73 lbs)

2.7 Environmental conditions

Storage temperature	: -10 to +50 °C (14 to 122 °F)
Ingress Protection	: IP67 (conform IEC 60529)

2.8 Mechanical specifications

Max. torque on sensor body : 7.5 Nm

2.9 Regulatory standards

IECEX

Applying standards : IEC 60079-0
 : IEC 60079-11
 Certificate no.* : IECEX DEK 11.0064X, issue 1
 Ex ia IIC T3...T6 Ga
 Electrical data : See Note 1
 Specific conditions : See Note 2
 of use

CE

- **ATEX** : Directive 2014/34/EU
 Applying standards : EN IEC 60079-0
 EN 60079-11
 Certificate no.* : DEKRA 11ATEX0014 X, issue 2
 Ⓢ II 1 G Ex ia IIC T3...T6 Ga
 Electrical data : See Note 1
 Specific conditions : See Note 2
 of use
- **ROHSII** : Directive 2011/65/EU
 Applying sensors, detectors and (ion sensitive)
 electrodes
- **PED** : Directive 2014/68/EU
 Applying article 4.3 (Sound Engineering Practice)



WARNING

Damaging the screw thread of the sensor might influence the maximum process pressure

- **LVD** : Directive 2014/35/EU
 Applying standards : NEN-EN-IEC 61010-1
 ANSI/ISA 61010-1
 CAN/CSA-C22.2 No. 61010-1

Note 1: Models without ID-chip (with fixed cable or VP type):
 I/O signals are from/to an associated intrinsically safe certified pH/ORP transmitter (e.g. Yokogawa transmitter Model FLX21/FLX202 series or Yokogawa transmitter Model PH202S series).

Models with ID-chip (VS type):
 I/O signals are from/to an associated intrinsically safe certified pH/ORP transmitter, Yokogawa Smart Adapter Model SA11-P1.

Sensor input circuits:

In type of protection intrinsic safety Ex ia IIC, only for connection to a certified intrinsically safe circuit, with the following maximum values:

$U_i=18\text{ V}$; $I_i=170\text{ mA}$; $P_i=0.4\text{ W}$;

$L_i=0.1\text{ mH}$ (models with fixed cable) or $L_i=0\text{ mH}$ (VS/VP type);

$C_i=150\text{ nF}$ (models with fixed cable) or

$C_i=0.4\text{ nF}$ (VS type) or $C_i=0\text{ nF}$ (VP type)



When the sensor has been connected to non intrinsically safe equipment which exceeds the restrictions regarding the sensor input circuits, the sensor is not suitable anymore for intrinsically safe use.

Note 2: Ambient temperature:

- 40 °C to +40 °C for temperature class T6,
- 40 °C to +55 °C for temperature class T4 and T5,
- 40° C to +105 °C for temperature class T3.



Electrostatic charges of the sensor enclosure parts and label shall be avoided, especially in the case that the process medium is non-conductive. Use a damp cloth for cleaning the equipment.

* Certification is subject to change, due to new regulations or changes in the product itself. When a certificate is updated, a new revision under the same certificate number is created with a new issue number.

- ATEX:
 - DEKRA11ATEX0014 X, issue 1 (effective from 03-2011)
 - DEKRA11ATEX0014 X, issue 2 (effective from 02-2021)
- IECEx:
 - IECEx DEK 11.0064X, issue 0 (effective from 07-2011)
 - IECEx DEK 11.0064X, issue 1 (effective from 02-2021)

Label information:

All statutory required label information is written on metallized product label. This includes MS-code, serial number and process operating specifications. The intrinsic safety certification information of ATEX and IECEx is also written on the product label. Example of a product label see figure 1.



Figure 1: Sensor product label

For other certification related information, the product label is not big enough to show all details. Therefore, the intrinsic certification information for FM-United States and FM-Canada an additional label is provided. This label needs to be attached to the sensor cable. Label content of additional label, see figure 2.

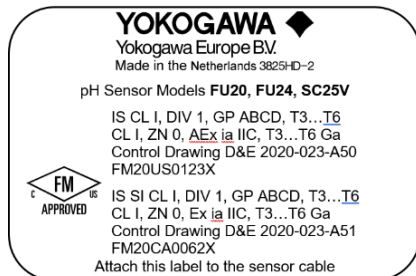

Figure 2: Product label FM-US and FM-CSA

FM-United States

Applying standards : FM Class 3600
 FM Class 3610
 FM Class 3810
 ANSI/ISA 60079-0
 ANSI/ISA 60079-11

Certificate no.* : FM20US0123X
 IS CL I, DIV 1, GP ABCD, T3...T6
 CL I, ZN 0, AEx ia IIC, T3...T6 Ga
 Control Drawing: D&E 2020-023-A50

Electrical data : See Note 3

Specific conditions : See Control Drawing D&E 2020-023-A50
 of use

Note 3: Intrinsically safe, entity, for Class I, Division 1, Groups A, B, C and D;
 Class I, Zone 0, AEx ia IIC, Ga (entity) for hazardous (classified) locations when
 installed per control drawing D&E 2020-023-A50.

Sensor input parameters:

$U_i = 18 \text{ V}$; $I_i = 170 \text{ mA}$; $P_i = 0.4 \text{ W}$;

$L_i = 0.1 \text{ mH}$ (models with fixed cable) or $L_i = 0 \text{ mH}$ (VS/VP type);

$C_i = 150 \text{ nF}$ (models with fixed cable) or

$C_i = 0.4 \text{ nF}$ (VS type) or $C_i = 0 \text{ nF}$ (VP type).

Ambient temperature:

-40 °C to +40 °C for temperature class T6,

-40 °C to +55 °C for temperature class T4 and T5,

-40 °C to +105 °C for temperature class T3.



When the sensor has been connected to non intrinsically safe equipment which
 exceeds the restrictions regarding the sensor input circuits, the sensor is not
 suitable anymore for intrinsically safe use.

* Certification is subject to change, due to new regulations or changes in the product itself.
 When a certificate is updated, a new revision under the same certificate number is created
 with a new date.

- FM-United States:
 FM20US0123X (effective from 03-2021)

Control drawing: D&E 2020-023-A50 (part 1)

Hazardous Location

IS CL I, DIV 1, GP ABCD T3 / T4 / T5 / T6
 CL I, ZN 0, AEx ia IIC, T3...T6 Ga
 Ta 105°C / 55°C / 55°C / 40°C

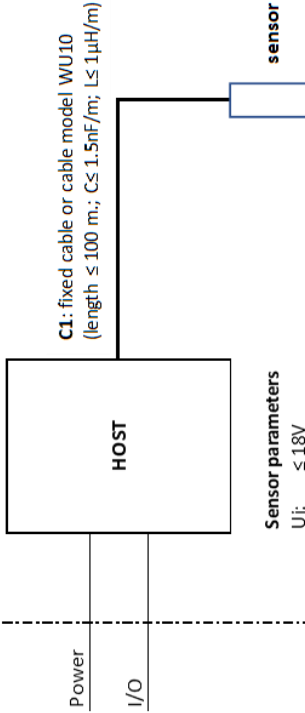

Sensor parameters

Ui: ≤ 18V

Ii: ≤ 170mA

Pi: ≤ 400mW

Ci: ≤ 0nF for sensor models with connector (without ID-chip)
 ≤ 0.4nF for sensor models with connector (including ID-chip)
 ≤ 150nF for sensor models with permanent cable

Remark:

Sensor Ci (in case of an integral cable the Ci includes the capacitance of the cable) shall not exceed the Co of the HOST.

Li: ≤ 0mH for sensor models with connector (without ID-chip)
 ≤ 0mH for sensor models with connector (including ID-chip)
 ≤ 0.1mH for sensor models with permanent cable

Remark:

Sensor Li (in case of an integral cable the Li includes the inductance of the cable) shall not exceed the Lo of the HOST.

Non-hazardous Location

Remarks:

- 1 No revision to this drawing without prior approval of FM.
- 2 Installation must be in accordance with the National Electrical Code (ANSI/NFPA 70), ANSI/ISA-RP12.06.01, and relevant local codes.
- 3 The sensor shall be installed to a certified intrinsically safe HOST with the following maximum values: $U_0 = 18\text{ V}$, $I_0 = 170\text{ mA}$, $P_0 = 400\text{ mW}$.
- 4 The sensor does not provide isolation from earth. Installers shall take necessary measures to prevent the possibility of sparking resulting from differing earth potentials between the sensors and interconnecting equipment. This can be realized for example by selecting interconnecting equipment which provides input-to-output and input-to-earth isolation up to 500 V rms.
- 5 Sensor Model code:

Table 3:

Model	Suffix Codes	Option Codes
FU24	-ab-cd-efg	/h

ab	Connection type:	Two alphanumeric characters identifying the length of the permanent cable, each character from 0 to 9
		VP Connector without ID-chip
		VS Connector with ID-chip
cd	Temperature sensor + Region:	T1 Pt1000, IS for ATEX/IECEX, FM-US, FM-CAN
efg	Type:	NPT PPS body/Tapered Thread/ Dome shaped
		FSM PPS body/Tapered Thread/ Flat Surface
h	Option code:	Up to ten alphanumeric characters (A to Z, 0 to 9 or hyphen)

- 6 **WARNING—POTENTIAL ELECTROSTATIC CHARGING HAZARD – SEE INSTRUCTIONS**
pH sensors containing accessible plastic parts and/or external conductive parts, must be installed and used in such a way, that dangers of ignition due to hazardous electrostatic charges cannot occur, especially in the case that the process medium is non-conductive.

Control drawing: D&E 2020-023-A50 (part 2)

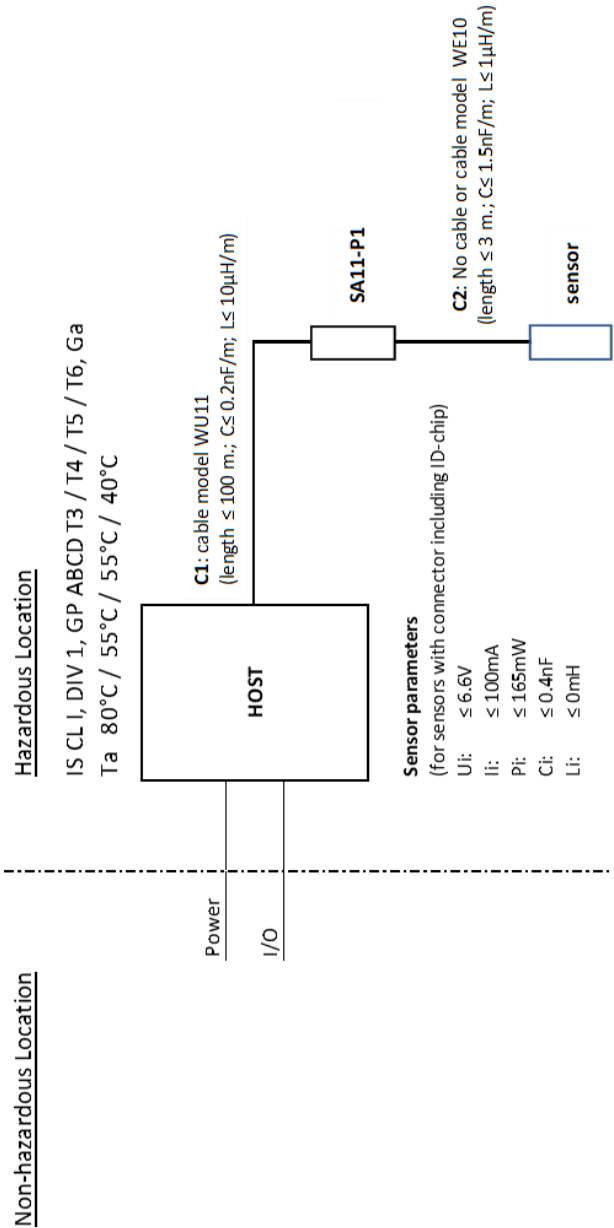

Remarks:

- 1 No revision to this drawing without prior approval of FM.
- 2 Installation must be in accordance with the National Electrical Code (ANSI/NFPA 70), ANSI/ISA-RP12.06.01, and relevant local codes.
- 3 The sensor shall be installed to a certified intrinsically safe Smart Adapter, model SA11-P1 with the following maximum values: $U_o = 6.6$ V, $I_o = 100$ mA, $P_o = 165$ mW.
- 4 The installers shall take necessary measures to prevent the possibility of sparking resulting from differing earth potentials between the sensors and interconnecting equipment. The sensor itself does not provide 500 V rms isolation from earth, the interconnecting equipment Model SA11-P1 Smart Adapter however provide this required isolation.
- 5 Sensor Model code:

Table 4:

Model	Suffix Codes	Option Codes
FU24	-ab-cd-efg	/h

ab	Connection type:	VS	Connector with ID-chip
cd	Temperature sensor + Region:	T1	Pt1000, IS for ATEX/IECEX, FM-US, FM-CAN
efg	Type:	NPT	PPS body/Tapered Thread/ Dome shaped
		FSM	PPS body/Tapered Thread/ Flat Surface
h	Option code:		Up to ten alphanumeric characters (A to Z, 0 to 9 or hyphen)

- 6 **WARNING—POTENTIAL ELECTROSTATIC CHARGING HAZARD – SEE INSTRUCTIONS**
pH sensors containing accessible plastic parts and/or external conductive parts, must be installed and used in such a way, that dangers of ignition due to hazardous electrostatic charges cannot occur, especially in the case that the process medium is non-conductive.

FM-Canada

Applying standards	: CAN/CSA-C22.2 No. 60079-0 CAN/CSA-C22.2 No. 60079-11
Certificate no.*	: FM20CA0062X IS CL I, DIV 1, GP ABCD, T3...T6 CL I, ZN 0, Ex ia IIC, T3...T6 Ga Control Drawing: D&E 2020-023-A51
Electrical data	: See Note 4.
Specific conditions of use	: See Control Drawing D&E 2020-023-A51.

Note 4: Intrinsically safe, entity, for Class I, Division 1, Groups A, B, C and D; Class I, Zone 0, Ex ia IIC, Ga (entity) for hazardous (classified) locations when installed per control drawing D&E 2020-023-A51.

Sensor input parameters:

$U_i = 18\text{V}$; $I_i = 170\text{ mA}$; $P_i = 0.4\text{ W}$;

$L_i = 0.1\text{ mH}$ (models with fixed cable) or $L_i = 0\text{ mH}$ (VS/VP type);

$C_i = 150\text{ nF}$ (models with fixed cable) or

$C_i = 0.4\text{ nF}$ (VS type) or $C_i = 0\text{ nF}$ (VP type).

Ambient temperature:

-40 °C to +40 °C for temperature class T6,

-40 °C to +55 °C for temperature class T4 and T5,

-40 °C to +105 °C for temperature class T3.

**WARNING**

When the sensor has been connected to non intrinsically safe equipment which exceeds the restrictions regarding the sensor input circuits, the sensor is not suitable anymore for intrinsically safe use.

* Certification is subject to change, due to new regulations or changes in the product itself. When a certificate is updated, a new revision under the same certificate number is created with a new date.

- FM-Canada:
FM20CA0062X (effective from 03-2021)

Control drawing: D&E 2020-023-A51 (part 1)

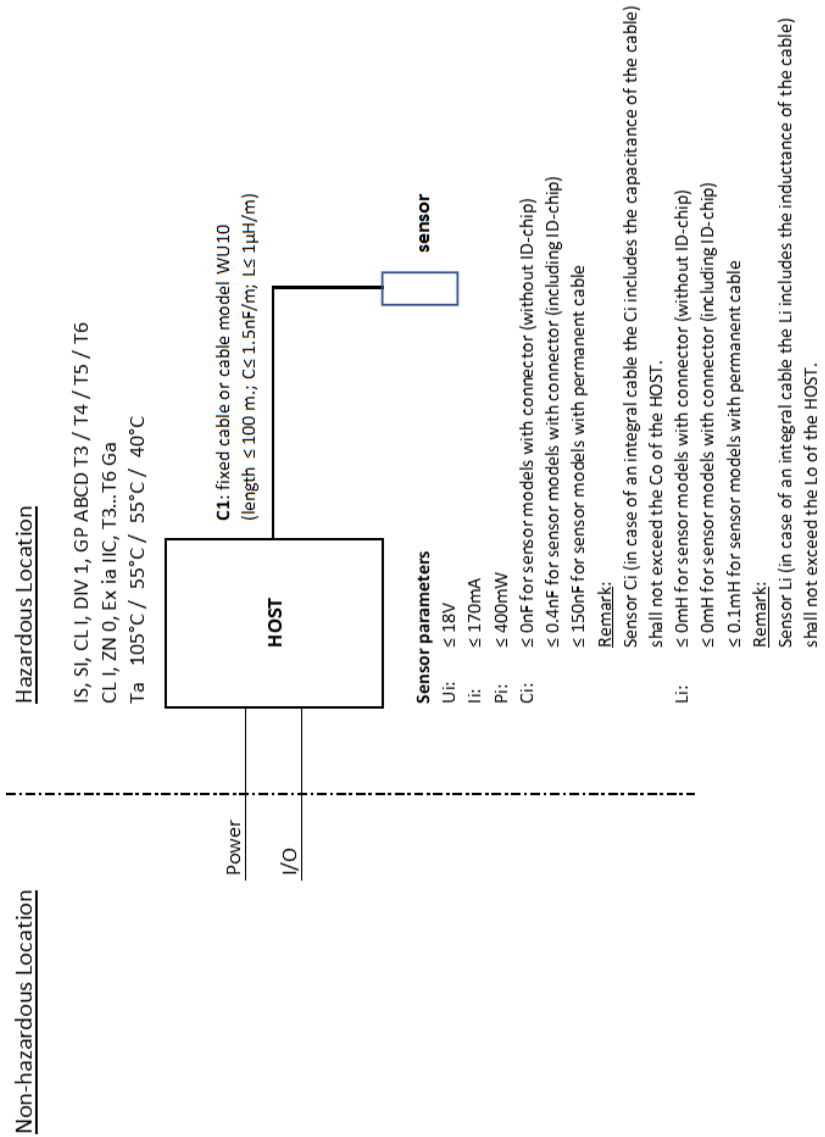

Remarks:

- 1 No revision to this drawing without prior approval of FM.
- 2 Installation must be in accordance with the Canadian Electrical Code (CEC) CSA22.1, and relevant local codes.
- 3 The sensor shall be installed to a certified intrinsically safe HOST with the following maximum values: Uo= 18 V, Io = 170 mA, Po = 400 mW.
- 4 The sensor does not provide isolation from earth. Installers shall take necessary measures to prevent the possibility of sparking resulting from differing earth potentials between the sensors and interconnecting equipment. This can be realized for example by selecting interconnecting equipment which provides input-to-output and input-to-earth isolation up to 500 V rms.
- 5 Sensor Model code:

Table 5:

Model	Suffix Codes	Option Codes
FU24	-ab-cd-efg	/h

ab	Connection type:	Two alphanumeric characters identifying the length of the permanent cable, each character from 0 to 9
		VP Connector without ID-chip
		VS Connector with ID-chip
cd	Temperature sensor + Region:	T1 Pt1000, IS for ATEX/IECEx, FM-US, FM-CAN
efg	Type:	NPT PPS body/Tapered Thread/ Dome shaped
		FSM PPS body/Tapered Thread/ Flat Surface
h	Option code:	Up to ten alphanumeric characters (A to Z, 0 to 9 or hyphen)

6 WARNING—POTENTIAL ELECTROSTATIC CHARGING HAZARD – SEE INSTRUCTIONS

pH sensors containing accessible plastic parts and/or external conductive parts, must be installed and used in such a way, that dangers of ignition due to hazardous electrostatic charges cannot occur, especially in the case that the process medium is non-conductive.

AVERTISSEMENT – DANGER POTENTIEL DE CHARGES ÉLECTROSTATIQUES – VOIR LES INSTRUCTIONS

Les sondes de pH contenant des pièces en plastique accessibles et / ou des pièces conductrices externes doivent être installées et utilisées de manière à éviter tout risque d'inflammation dû à des charges électrostatiques dangereuses, en particulier dans le cas où le fluide de procédé n'est pas conducteur.

Control drawing: D&E 2020-023-A51 (part 2)

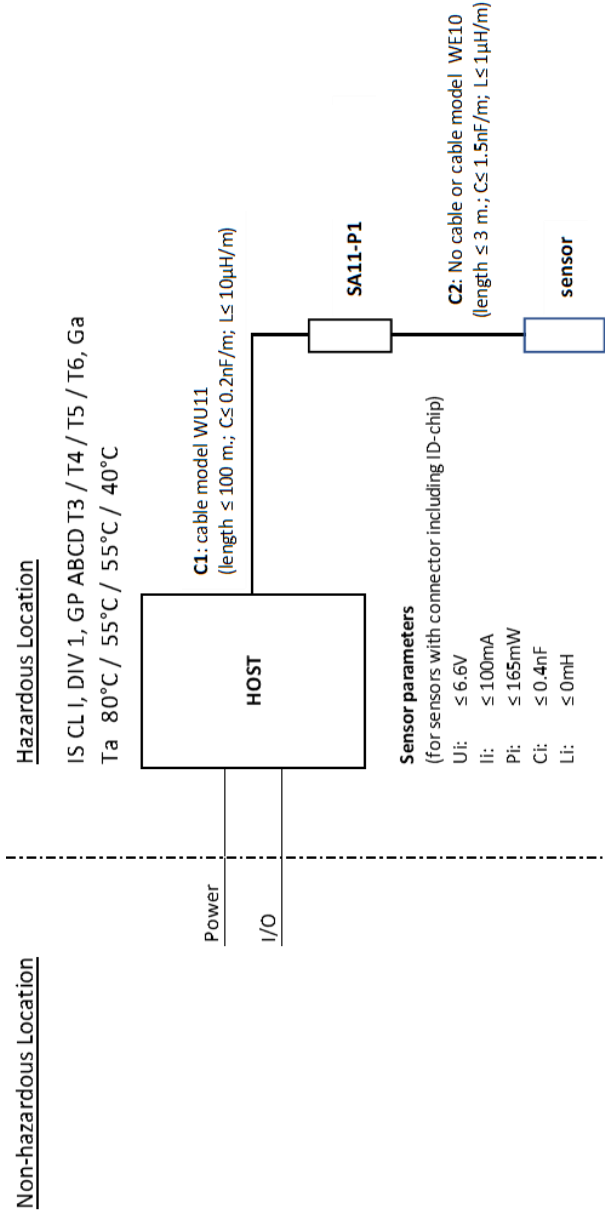

Remarks:

1. No revision to this drawing without prior approval of FM.
2. Installation must be in accordance with the Canadian Electrical Code (CEC) CSA22.1, and relevant local codes.
3. The sensor shall be installed to a certified intrinsically safe Smart Adapter, model SA11-P1 with the following maximum values: $U_0 = 6.6 \text{ V}$, $I_0 = 100 \text{ mA}$, $P_0 = 165 \text{ mW}$.
4. The installers shall take necessary measures to prevent the possibility of sparking resulting from differing earth potentials between the sensors and interconnecting equipment. The sensor itself does not provide 500 V rms isolation from earth, the interconnecting equipment Model SA11-P1 Smart Adapter however provide this required isolation.
5. Sensor Model code:

Table 6:

Model	Suffix Codes	Option Codes
FU24	-ab-cd-efg	/h

ab	Connection type:	VS	Connector with ID-chip
cd	Temperature sensor + Region:	T1	Pt1000, IS for ATEX/IECEX, FM-US, FM-CAN
efg	Type:	NPT	PPS body/Tapered Thread/ Dome shaped
		FSM	PPS body/Tapered Thread/ Flat Surface
h	Option code:	Up to ten alphanumeric characters (A to Z, 0 to 9 or hyphen)	

WARNING—POTENTIAL ELECTROSTATIC CHARGING HAZARD – SEE INSTRUCTIONS

pH sensors containing accessible plastic parts and/or external conductive parts, must be installed and used in such a way, that dangers of ignition due to hazardous electrostatic charges cannot occur, especially in the case that the process medium is non-conductive.

DANGER POTENTIEL DE CHARGES ÉLECTROSTATIQUES – VOIR LES INSTRUCTIONS

Les sondes de pH contenant des pièces en plastique accessibles et / ou des pièces conductrices externes doivent être installées et utilisées de manière à éviter tout risque d'inflammation dû à des charges électrostatiques dangereuses, en particulier dans le cas où le fluide de procédé n'est pas conducteur.

3. INSTALLATION OF FU24

For optimum measurement results, the FU24 should be installed in a location that offers an acceptable representation of the process composition and **DOES NOT** exceed the specifications of the sensor. The FU24 is designed with 1" NPT threaded connections on both ends of the sensor to allow installation in a wide variety of applications.

3.1 Typical installation

The FU24 sensor is designed for versatile in-line, immersion or bypass loop installation. For best results the FU24 should be mounted with the process flow coming towards the sensor. The sensor can be mounted in all angles with respect to the horizontal plane (including Upside Down mounting).

3.2 Preparing the sensor for use

Remove the sensor from its shipping box and slide of the so-called 'wet pocket', the tube filled with solution to prevent drying out of the measuring elements during shipment or storage. Although on the Quality Inspection Certificate (QIC) all factory calibration data is stored, it is recommended to calibrate the sensor before first use. A general calibration procedure is described in Section 6 of this Instruction Manual.

3.3 Mounting the sensor

The simplest mounting is to use one of the 1" NPT threaded connection of the sensor. Apply Teflon tape to the appropriate threaded end, then install the sensor in the process. Tighten the sensor using a wrench on the sensor flats.

Note: DO NOT over tighten the sensor to prevent damage. The maximum applicable torque is 7.5 Nm.

4. DIMENSIONS

Dimensions in mm (inches)

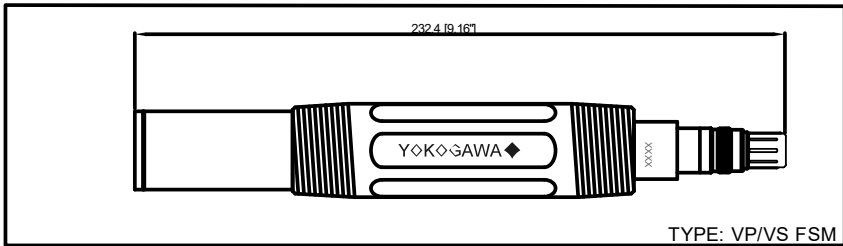
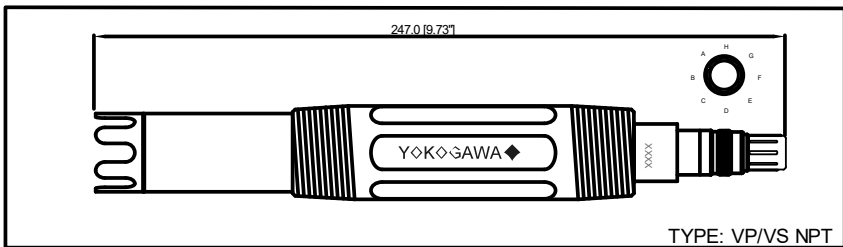
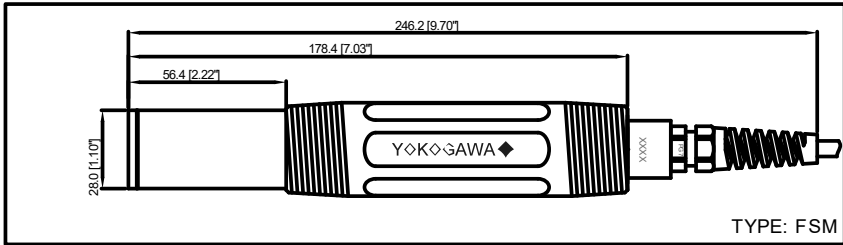
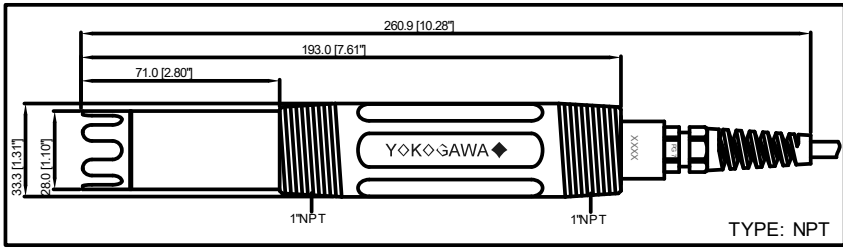

Figure 3: Dimensions FU24

5. WIRING

The FU24 sensor is provided with a fixed cable or a 8 pins Vario Pin connector (type VP without ID-chip and type VS with ID-chip).

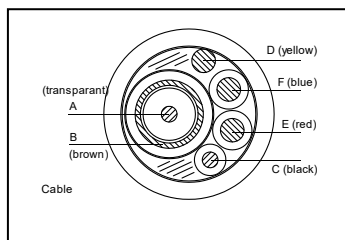

Figure 4: Connection diagram fixed cable

Table 7:

Item	Wire Pin no.	Wire color	Description
A	15	Transparent	pH Guard
B	16	Brown	pH Guard
C	13	Black	Reference
D	14	Yellow	LE/ORP
E	11	Red	Pt1000
F	12	Blue	Pt1000

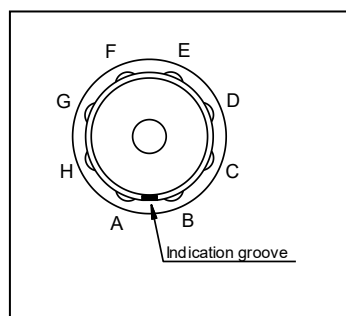

Table 8:

Pin no.	Description VP type	Description VS type
A	pH	pH
B	Reference	Reference
C	pH Guard	pH Guard
D	LE/ORP	LE/ORP
E	Pt1000	Pt1000
F	Pt1000	Pt1000/ID-chip GND
G	Not available	ID-chip VCC
H	Not available	ID-chip DATA

Figure 5: Connection diagram connector type

Note: Preferred connection cable is Yokogawa Model WU10-V-D or Model WE10

6. GENERAL CALIBRATION & MAINTENANCE PROCEDURE

6.1 Calibration for pH measurement

To calibrate the FU24 pH/ORP sensor, two buffer solutions with known pH values are required. It is recommended that one buffer solution has a value near to pH 7.00. Depending on the process value to be measured, the second buffer solution should be either acidic (below pH 7.00) or alkaline (above pH 7.00). Normally the IEC buffers (pH 4.01, 6.87 and 9.18) are used.

The following is a very general 2-point calibration procedure:

1. Clean the sensor using a 5% solution of HCl;
2. Rinse sensor thoroughly with demineralized water;
3. Immerse the sensor in the first buffer (pH 6.87 is recommended) and execute calibration as described in the Instruction Manual of the analyzer.
4. Rinse sensor thoroughly with demineralized water;
5. Immerse the sensor in the second buffer (pH 4.01 or 9.18 is recommended) and execute calibration as described in the Instruction Manual of the analyzer.
6. Rinse sensor thoroughly with demineralized water.

During calibration, the temperature compensation should be active. The EXA/FLXA analyzer automatically compensates for the sensitivity change of the pH sensor at different temperatures.

After calibration, replace or re-install the sensor into the process.

6.2 Calibration for ORP and rH measurement

For calibration of ORP and rH, the procedure for MANUAL CALIBRATION can be used as described in the Instruction Manual of the analyzer.

The rH value is a function of the reference system and the pH value of the buffer solution. The FU24 sensor has a reference system of saturated Silver/Silver Chloride (Ag/AgCl). The commonly used standards for ORP and rH calibration are made from Chinhydrone (Quinhydrone) powder dissolved in pH buffer solutions (1 g / 200 ml). In Table 9 the measurement values are given as function of the used pH buffer solution with Chinhydrone powder. The accuracy of the standards is approximately ± 10 mV.

Table 9: ORP, pH compensated ORP and rH as function of pH buffer solution with Chinhydrone powder.

pH buffer	ORP (mV)	pH compensated	rH
1.68	403	88	23.6
4.01	265	88	23.6
6.87	96	88	23.6
7.00	88	88	23.6

6.3 Maintenance of the FU24 sensor

A pH sensor requires routine maintenance to keep the measuring elements clean and functioning. Depending on the process, different cleaning solutions may be required.



Avoid cleaning the complete sensor with solution. Some cleaning solutions will damage the model code sticker and connector which are placed on top of the sensor. Only clean the measuring elements at the bottom side of the sensor.

In most cases cleaning with water, iso-propanol or methanol is sufficient. In other cases, the measuring elements of the sensor have to be cleaned with specific solutions.

Examples:

1. Deposits of limes, hydroxides or carbonates can be removed by immersing the bottom part of the sensor in a solution containing dilute hydrochloric acid (5% is recommended). Afterwards rinse the sensor with water.
2. Deposits of oil and fat can be removed with hot water with a detergent. When the results are unsatisfactory, a mild (carbonate based) abrasive can be used.
3. Protein deposits should be removed with a protein enzymatic solution, for instance a solution containing 8.5 mL concentrated hydrochloric acid and 10 grams of pepsin in 1 liter of water.

Note: Avoid cleaning with non-polar solvent like tri-chloro ethylene, toluene or hexane. The non-polar solvents will break up the gel-layer on the pH glass bulb and requires that the sensor has to be soaked in water for at least 12 hours before it will function again.

The Teflon diaphragm of the sensor can be regenerated by putting it in hot ($\pm 70\text{ }^{\circ}\text{C}$, $158\text{ }^{\circ}\text{F}$) 3 molar Potassium Chlorine (KCl) solution and letting it cool down to room temperature. This procedure clears the diaphragm and will soak the diaphragm with conductive KCl again.

7. MODEL CODES

Table 10:

Model Code	Suffix code	Option code	Description
FU24			Wide body sensor
Type	- VP - VS - 05 - 10		Variopin connector Variopin connector for SENCOM Fixed cable, 5 meter Fixed cable, 10 meter
Temp. Element	-T1		Pt1000
Model		-NPT -FSM	Dome shape model, heavy duty Flat surface model, self-cleaning

8. SPARE PARTS

Table 11:

Spare part		Description
K1521JA	FU24	Holder for FU24(F) in FF20-S3* (SS) (1"NPT)
K1521JB		Holder for FU24(F) in FF20-F3* (PVDF) (1"NPT)
K1520BA	Buffer solutions	Buffer Solution pH4.01+6.87+9.18(3x0.5L)
K1520BB		Buffer Solution pH 1.68 (3x 0.5L)
K1520BC		Buffer Solution pH 4.01 (3x 0.5L)
K1520BD		Buffer Solution pH 6.87 (3x 0.5L)
K1520BE		Buffer Solution pH 9.18 (3x 0.5L)
WU10-V-D-XX	Connection cables for Suffix -05,-10,-VP	Variopin cable (XX = 02, 05, 10, 15 and 20m)
WU10-V-S-XX		Variopin cable (XX = 02, 05, 10, 15 and 20m)
WE10-H-D-XX		Extension cable for SENCOM SMART ADAPTER SA11
BA11	Connection equipment for Suffix -VS	Active Junction box
SA11-P1		SENCOM SMART adapter
WU11		Interconnection cable
IB100		Interface box

9. CHEMICAL COMPATIBILITY CHART

Table 12:

				Material													
				Viton			PTFE (teflon)			PPS (Ryton)			Glass				
				Conc. %	Temp. °C	20	60	100	20	60	100	20	60	100	20	60	100
Inorganic acid	Sulfuric acid	10		o	o	o	o	o	o	o	o	o	o	o	o	o	o
		50		o	o	o	o	o	o	x	x	x	o	o	o	o	o
		95		o	o	o	o	o	o	x	x	-	o	o	o	o	o
		fuming		o	o	o	o	o	o				o	o	o	o	o
	Hydrochloric acid	10		o	o	o	o	o	o	o	o	o	o	o	o	o	o
		sat.		o	o	o	o	o	o	o	o	o	o	o	o	o	o
	Nitric acid	25		o	o	x	o	o	o	o	o	o	o	o	o	o	o
		50		-	-	-	o	o	o	x	x	x	o	o	o	o	o
		95		-	-	-	o	o	o	o	-	-	-	o	o	o	o
		fuming		-	-	-	o	o	o	o				o	o	o	o
	Phosphoric acid	25		o	o	o	o	o	o	o	o	o	o	o	o	o	o
		50		o	o	o	o	o	o	o	o	o	o	o	o	o	o
95			x	x	-	o	o	o	o	o	o	o	o	o	o	o	
Hydrofluoric acid	40		o	o	o	o	o	o	x	x	x	x	x	x	x	x	
	75		o	o	x	o	o	o	o	-	-	-	-	-	-	-	
Organic acid	Acetic acid	10		-	-	-	o	o	o	o	o	o	o	o	o	o	
	glacial		-	-	-	o	o	o	o	o	o	o	o	o	o	o	
	Formic acid	80		-	-	-	o	o	o	o	o	o	o	o	o	o	
	Citric acid	50		o	o	o	o	o	o	o	o	o	o	o	o	o	
Alkali	Calcium hydroxide	sat.		o	o	o	o	o	o	o	o	o	o	o	o	o	
	Potassium hydroxide	50		o	o	o	o	o	o	o	o	o	o	o	o	x	
	Sodium hydroxide	40		x	x	x	o	o	o	o	o	o	o	o	o	x	
	Ammonia in water	30		x	x	x	o	o	o	o	o	o	o	o	o	x	
Acid salt	Ammonium chloride	sat.		o	o	o	o	o	o	o	o	o	o	o	o	o	
	Zinc chloride	50		o	o	o	o	o	o	o	o	o	o	o	o	o	
	Iron(III) chloride	50		o	o	o	o	o	o	o	o	o	o	o	o	o	
	Sodium sulfite	sat.		-	-	-	o	o	o	o	o	o	o	o	o	o	
Basic salt	Sodium carbonate	sat.		o	o	o	o	o	o	o	o	o	o	o	o	o	
	Potassium chloride	sat.		o	o	o	o	o	o	o	o	o	o	o	o	o	
	Sodium sulfate	sat.		o	o	o	o	o	o	o	o	o	o	o	o	o	
	Calcium chloride	sat.		o	o	o	o	o	o	o	o	o	o	o	o	o	
Neutral salt	Sodium chloride	sat.		o	o	o	o	o	o	o	o	o	o	o	o	o	
	Sodium nitrate	50		o	o	o	o	o	o	o	o	o	o	o	o	o	
	Aluminum chloride	sat.		o	o	o	o	o	o	o	o	o	o	o	o	o	
	Hydrogen peroxide	30		o	o	o	o	o	o	x	-	-	o	o	o		
Oxidizing agent	Sodium Hypochlorite	50		o	o	x	o	o	o	x			o	o	o		
	Potassium dichromate	sat.		o	o	o	o	o	o	x			o	o	o		
	Chlorinated lime						o	o	o	o			o	o	o		
	Ethanol	80		x	-	-	o	o	o	o	o	o	o	o	o		
Organic solvent	Cyclohexane			o	o	o	o	o	o	o	o	o	o	o	o	o	
	Toluene			-	-	-	o	o	o	o	o	o	o	o	o		
	Trichloroethane			x	x	x	o	o	o	o	o	o	o	o	o		
	Water			o	o	o	o	o	x	o	o	o	o	o	o		

o = can be used x = shortens useful life - = cannot be used Blank = no data currently available

Note: Information in this list is based on our general experience and literature data and given in good faith. However, Yokogawa is unable to accept responsibility for claims related to this information.

YOKOGAWA ELECTRIC CORPORATION
World Headquarters
9-32, Nakacho 2-chome, Musashino-shi
Tokyo 180-8750
Japan
www.yokogawa.com

YOKOGAWA CORPORATION OF AMERICA
2 Dart Road
Newnan GA 30265
USA
www.yokogawa.com/us

YOKOGAWA EUROPE BV
Euroweg 2
3825 HD AMERSFOORT
The Netherlands
www.yokogawa.com/eu

YOKOGAWA ELECTRIC ASIA Pte. LTD.
5 Bedok South Road
Singapore 469270
Singapore
www.yokogawa.com/sg

YOKOGAWA CHINA CO. LTD.
Room 1301, Tower 5, THE PLACE
No.100 Zunyi Road
Changing District, Shanghai, China
www.yokogawa.com/cn

YOKOGAWA MIDDLE EAST B.S.C.(c)
P.O. Box 10070, Manama
Building 577, Road 2516, Busaitteen 225
Muharraq, Bahrain
www.yokogawa.com/bh

Yokogawa has an extensive sales and distribution network. Please refer to the European website (www.yokogawa.com/eu) to contact your nearest representative.



YOKOGAWA ◆

IM 12B06J03-03EN-P
Subject to change without notice
Copyright ©

Printed in The Netherlands, 01-2101

IM 12B06J03-03EN-P