

# Operating Instructions

Radiometric sensor for level detection

## POINTRAC 31

Four-wire 8/16 mA/HART



Document ID: 39411



**VEGA**

# Contents

<b>1</b>	<b>About this document</b> .....	<b>4</b>
1.1	Function .....	4
1.2	Target group .....	4
1.3	Symbols used.....	4
<b>2</b>	<b>For your safety</b> .....	<b>5</b>
2.1	Authorised personnel .....	5
2.2	Appropriate use.....	5
2.3	Warning about incorrect use.....	5
2.4	General safety instructions .....	5
2.5	EU conformity.....	6
2.6	NAMUR recommendations .....	6
2.7	Installation and operation in the USA and Canada .....	6
2.8	Environmental instructions .....	6
<b>3</b>	<b>Product description</b> .....	<b>7</b>
3.1	Configuration.....	7
3.2	Principle of operation.....	8
3.3	Packaging, transport and storage.....	8
3.4	Accessories.....	9
3.5	Corresponding source container .....	11
<b>4</b>	<b>Mounting</b> .....	<b>13</b>
4.1	General instructions .....	13
4.2	Mounting instructions .....	14
<b>5</b>	<b>Connecting to power supply</b> .....	<b>20</b>
5.1	Preparing the connection .....	20
5.2	Connection.....	23
<b>6</b>	<b>Set up with the display and adjustment module</b> .....	<b>26</b>
6.1	Insert display and adjustment module .....	26
6.2	Adjustment system .....	27
6.3	Parameter adjustment .....	28
6.4	Saving the parameterisation data.....	39
<b>7</b>	<b>Setup with PACTware</b> .....	<b>40</b>
7.1	Connect the PC.....	40
7.2	Parameter adjustment with PACTware .....	41
7.3	Saving the parameterisation data .....	42
<b>8</b>	<b>Set up with other systems</b> .....	<b>43</b>
8.1	DD adjustment programs .....	43
8.2	Field Communicator 375, 475 .....	43
<b>9</b>	<b>Diagnostics and servicing</b> .....	<b>44</b>
9.1	Maintenance .....	44
9.2	Status messages.....	44
9.3	Rectify faults.....	47
9.4	Exchanging the electronics module.....	48
9.5	Software update .....	48
9.6	How to proceed if a repair is necessary.....	49

<b>10 Dismount.....</b>	<b>50</b>
10.1 Dismounting steps.....	50
10.2 Disposal .....	50
<b>11 Supplement .....</b>	<b>51</b>
11.1 Technical data .....	51
11.2 Dimensions .....	55
11.3 Industrial property rights.....	60
11.4 Trademark .....	60



**Safety instructions for Ex areas**

Take note of the Ex specific safety instructions for Ex applications. These instructions are attached as documents to each instrument with Ex approval and are part of the operating instructions.

Editing status: 2021-03-04

# 1 About this document

## 1.1 Function

This instruction provides all the information you need for mounting, connection and setup as well as important instructions for maintenance, fault rectification, the exchange of parts and the safety of the user. Please read this information before putting the instrument into operation and keep this manual accessible in the immediate vicinity of the device.

## 1.2 Target group

This operating instructions manual is directed to trained personnel. The contents of this manual must be made available to the qualified personnel and implemented.

## 1.3 Symbols used



### Document ID

This symbol on the front page of this instruction refers to the Document ID. By entering the Document ID on [www.vega.com](http://www.vega.com) you will reach the document download.



**Information, note, tip:** This symbol indicates helpful additional information and tips for successful work.



**Note:** This symbol indicates notes to prevent failures, malfunctions, damage to devices or plants.



**Caution:** Non-observance of the information marked with this symbol may result in personal injury.



**Warning:** Non-observance of the information marked with this symbol may result in serious or fatal personal injury.



**Danger:** Non-observance of the information marked with this symbol results in serious or fatal personal injury.



### Ex applications

This symbol indicates special instructions for Ex applications.



### List

The dot set in front indicates a list with no implied sequence.



### Sequence of actions

Numbers set in front indicate successive steps in a procedure.



### Battery disposal

This symbol indicates special information about the disposal of batteries and accumulators.

## 2 For your safety

### 2.1 Authorised personnel

All operations described in this documentation must be carried out only by trained, qualified personnel authorised by the plant operator.

During work on and with the device, the required personal protective equipment must always be worn.

### 2.2 Appropriate use

The POINTRAC 31 is a sensor for point level detection.

You can find detailed information about the area of application in chapter " *Product description*".

Operational reliability is ensured only if the instrument is properly used according to the specifications in the operating instructions manual as well as possible supplementary instructions.

### 2.3 Warning about incorrect use

Inappropriate or incorrect use of this product can give rise to application-specific hazards, e.g. vessel overfill through incorrect mounting or adjustment. Damage to property and persons or environmental contamination can result. Also, the protective characteristics of the instrument can be impaired.

### 2.4 General safety instructions

This is a state-of-the-art instrument complying with all prevailing regulations and directives. The instrument must only be operated in a technically flawless and reliable condition. The operator is responsible for the trouble-free operation of the instrument. When measuring aggressive or corrosive media that can cause a dangerous situation if the instrument malfunctions, the operator has to implement suitable measures to make sure the instrument is functioning properly.

The safety instructions in this operating instructions manual, the national installation standards as well as the valid safety regulations and accident prevention rules must be observed by the user.

For safety and warranty reasons, any invasive work on the device beyond that described in the operating instructions manual may be carried out only by personnel authorised by the manufacturer. Arbitrary conversions or modifications are explicitly forbidden. For safety reasons, only the accessory specified by the manufacturer must be used.

To avoid any danger, the safety approval markings and safety tips on the device must also be observed.

This measuring system uses gamma rays. Therefore take note of the instructions for radiation protection in chapter "*Product description*". Any work on the source container may only be carried out under the supervision of a qualified radiation protection officer.

## 2.5 EU conformity

The device fulfils the legal requirements of the applicable EU directives. By affixing the CE marking, we confirm the conformity of the instrument with these directives.

The EU conformity declaration can be found on our homepage.

### Electromagnetic compatibility

Instruments in four-wire or Ex-d-ia version are designed for use in an industrial environment. Nevertheless, electromagnetic interference from electrical conductors and radiated emissions must be taken into account, as is usual with class A instruments according to EN 61326-1. If the instrument is used in a different environment, the electromagnetic compatibility to other instruments must be ensured by suitable measures.

## 2.6 NAMUR recommendations

NAMUR is the automation technology user association in the process industry in Germany. The published NAMUR recommendations are accepted as the standard in field instrumentation.

The device fulfils the requirements of the following NAMUR recommendations:

- NE 21 – Electromagnetic compatibility of equipment
- NE 43 – Signal level for fault information from measuring transducers
- NE 53 – Compatibility of field devices and display/adjustment components
- NE 107 – Self-monitoring and diagnosis of field devices

For further information see [www.namur.de](http://www.namur.de).

## 2.7 Installation and operation in the USA and Canada

This information is only valid for USA and Canada. Hence the following text is only available in the English language.

Installations in the US shall comply with the relevant requirements of the National Electrical Code (ANSI/NFPA 70).

Installations in Canada shall comply with the relevant requirements of the Canadian Electrical Code.

## 2.8 Environmental instructions

Protection of the environment is one of our most important duties. That is why we have introduced an environment management system with the goal of continuously improving company environmental protection. The environment management system is certified according to DIN EN ISO 14001.

Please help us fulfil this obligation by observing the environmental instructions in this manual:

- Chapter " *Packaging, transport and storage* "
- Chapter " *Disposal* "

### 3 Product description

#### 3.1 Configuration

##### Type label

The type label contains the most important data for identification and use of the instrument:

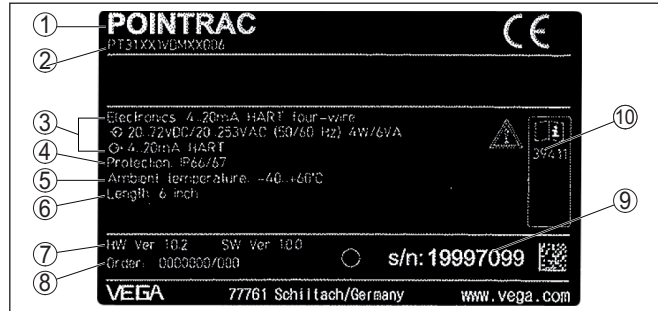

Fig. 1: Layout of the type label (example)

- 1 Instrument type
- 2 Product code
- 3 Electronics
- 4 Protection rating
- 5 Process and ambient temperature, process pressure
- 6 Instrument length
- 7 Hardware and software version
- 8 Order number
- 9 Serial number of the instrument
- 10 ID numbers, instrument documentation

##### Serial number - Instrument search

The type label contains the serial number of the instrument. With it you can find the following instrument data on our homepage:

- Product code (HTML)
- Delivery date (HTML)
- Order-specific instrument features (HTML)
- Operating instructions and quick setup guide at the time of shipment (PDF)
- Order-specific sensor data for an electronics exchange (XML)
- Test certificate (PDF) - optional

Move to "[www.vega.com](http://www.vega.com)" and enter in the search field the serial number of your instrument.

Alternatively, you can access the data via your smartphone:

- Download the VEGA Tools app from the "Apple App Store" or the "Google Play Store"
- Scan the DataMatrix code on the type label of the instrument or
- Enter the serial number manually in the app

##### Scope of this operating instructions

This operating instructions manual applies to the following instrument versions:

- Hardware from 1.0.6 <sup>1)</sup>
- Software from 2.1.0
- Hardware from 2.0.0
- Software from 3.0.0

### Electronics versions

The instrument is available in different electronics versions. Each version can be identified via the product code on the type label:

- Standard electronics type PROTRACH.-XX

### Scope of delivery

The scope of delivery encompasses:

- Radiometric sensor
- Mounting accessories
- Documentation
- Bluetooth module (optional)
  - This operating instructions manual
  - Ex-specific "*Safety instructions*" (with Ex versions)
  - If necessary, further certificates

## 3.2 Principle of operation

### Application area

The instrument is suitable for applications in liquids and bulk solids in vessels under difficult process conditions. There are application possibilities in nearly all areas of industry.

The limit level is detected contactlessly through the vessel wall. Neither a process fitting nor a vessel opening is required. The instrument is thus ideal for retrofitting.

### Functional principle

In radiometric measurement, a Caesium-137 or Cobalt-60 isotope emits focussed gamma rays that are attenuated when penetrating the vessel wall and the medium. The PVT detector on the opposite side of the tank receives the radiation. When the intensity of the radiation drops below a defined value, e.g. due to damping, then the POINTRAC 31 switches. The measuring principle has proven itself well under extreme conditions because it measures contactlessly from outside through the vessel wall. The measuring system ensures maximum safety, reliability and plant availability independent of the medium and its properties.

## 3.3 Packaging, transport and storage

### Packaging

Your instrument was protected by packaging during transport. Its capacity to handle normal loads during transport is assured by a test based on ISO 4180.

The packaging consists of environment-friendly, recyclable cardboard. For special versions, PE foam or PE foil is also used. Dispose of the packaging material via specialised recycling companies.

<sup>1)</sup> It is not possible to update the software to 3.0.0. In this case the electronics module must be exchanged.



<b>Transport</b>	Transport must be carried out in due consideration of the notes on the transport packaging. Nonobservance of these instructions can cause damage to the device.
<b>Transport inspection</b>	The delivery must be checked for completeness and possible transit damage immediately at receipt. Ascertained transit damage or concealed defects must be appropriately dealt with.
<b>Storage</b>	<p>Up to the time of installation, the packages must be left closed and stored according to the orientation and storage markings on the outside.</p> <p>Unless otherwise indicated, the packages must be stored only under the following conditions:</p> <ul style="list-style-type: none"> <li>● Not in the open</li> <li>● Dry and dust free</li> <li>● Not exposed to corrosive media</li> <li>● Protected against solar radiation</li> <li>● Avoiding mechanical shock and vibration</li> </ul>
<b>Storage and transport temperature</b>	<ul style="list-style-type: none"> <li>● Storage and transport temperature see chapter " <i>Supplement - Technical data - Ambient conditions</i>"</li> <li>● Relative humidity 20 ... 85 %</li> </ul>
<b>Lifting and carrying</b>	With instrument weights of more than 18 kg (39.68 lbs) suitable and approved equipment must be used for lifting and carrying.

### 3.4 Accessories

<b>PLICSCOM</b>	<p>The display and adjustment module is used for measured value indication, adjustment and diagnosis.</p> <p>The integrated Bluetooth module (optional) enables wireless adjustment via standard adjustment devices.</p>
<b>VEGACONNECT</b>	The interface adapter VEGACONNECT enables the connection of communication-capable instruments to the USB interface of a PC.
<b>VEGADIS 81</b>	The VEGADIS 81 is an external display and adjustment unit for VEGA plics <sup>®</sup> sensors.
<b>VEGADIS 82</b>	VEGADIS 82 is suitable for measured value indication and adjustment of sensors with HART protocol. It is looped into the 4 ... 20 mA/HART signal cable.
<b>External indicating unit</b>	The VEGADIS 62 is suitable for measured value indication of sensors. It is looped into the 4 ... 20 mA/HART signal cable.
<b>Electronics module - PT30</b>	<p>The electronics module PT30... is a replacement part for radiometric sensors POINTRAC 31.</p> <p>It is located in the large electronics and connection compartment.</p> <p>The electronics module can only be exchanged by VEGA service technician.</p>

**Supplementary electronics module - PROTRAC.ZE**

The supplementary electronics module PROTRAC.ZE... is a replacement part for radiometric sensors POINTRAC 31.

It is located in the lateral adjustment and connection compartment.

**Device cooling**

The radiometric sensor has temperature limits which must not be exceeded. In case the max. permissible temperature is exceeded, faulty measurements and a permanent damage of the sensor can be caused.

You have several possibilities to avoid too high ambient temperatures:

**Passive sun shade**

Direct sun increases the temperature on the sensor by 20 °K. The best possibility to protect the sensor against the effects of direct sun is a suitable roof structure.

If this is not possible or only with great effort, then you can use the passive sun shade. The passive sun shade consists of a housing sun shade and a sun protection hose and can reduce the sensor temperature by 10 °K.

**Air cooling**

For ambient temperatures up to +80 °C you can use an air cooling. The cooling air is generated with vortex coolers. Please check if sufficient compressed air is available. You can find further information in the supplementary instructions of the air cooling. The air cooling cannot be retrofitted.

**Water cooling**

For ambient temperatures up to +100 °C you can use a water cooling. Please check if sufficient cooled water is available. You can find further information in the supplementary instructions of the water cooling. The water cooling cannot be retrofitted.

**Gamma modulator**

In order to exclude external interference radiation, you can mount a gamma modulator in front of the source holder. This allows reliable measurement even when interference radiation occurs.

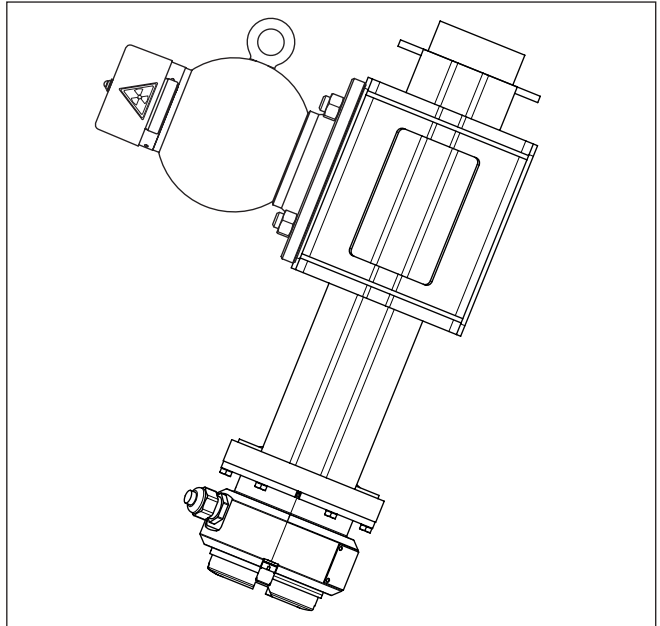

Fig. 2: Gamma modulator (optional) for uninterrupted measurement even with interference radiation

1 Gamma modulator (mounted on the source holder)

For ambient temperatures up to 120 °C (248 °C) the gamma modulator is optionally available with water cooling.

Any number of devices can be synchronized. To synchronize several gamma modulators, you need a controller.

### 3.5 Corresponding source container

A radioactive isotope in a suitable source holder is the prerequisite for a radiometric measurement setup.

The handling of radioactive substances is regulated by law. The radiation protection rules of the country in which the system is operated apply first and foremost.

In Germany, for example, the current radiation protection ordinance (StrlSchV) based on the Atomic Energy Law (AtG) applies.

The following points are important for measurement with radiometric methods:

A handling permit is required for operation of a system using gamma rays. This permit is issued by the respective government office or the responsible authority (in Germany, for example, offices for environmental protection, trade supervisory boards, etc.)

You can find further instructions in the operating instructions manual of the source container.

### General instructions for radiation protection

When handling radioactive sources, unnecessary radiation exposure must be avoided. An unavoidable radiation exposure must be kept as low as possible. Take note of the following three important measures:

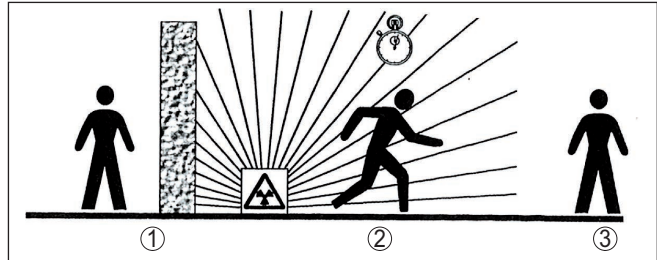

Fig. 3: Measures for protection against radioactive radiation

- 1 Shielding
- 2 Time
- 3 Distance

**Shielding:** Provide good shielding between the source and yourself as well as all other persons. Special source containers (e.g. VEGASOURCE) as well as all materials with high density (e.g. lead, iron, concrete, etc.) provide effective shielding.

**Time:** Stay as short a time as possible in radiation exposed areas.

**Distance:** Your distance to the source should be as large as possible. The local dose rate of the radiation decreases in proportion to the square of the distance to the radiation source.

### Radiation safety officer

The plant operator must appoint a radiation safety officer with the necessary expert knowledge. He is responsible for ensuring that the radiation protection ordinance is complied with and for implementing all radiation protection measures.

### Control area

Control areas are areas in which the local dose rate exceeds a certain value. Only persons who undergo official dose monitoring are allowed into these control areas. You can find the respectively valid limit values for control areas in the guideline of the respective authority (in Germany, for example, the radiation protection ordinance).

We are at your disposal for further information concerning radiation protection and regulations in other countries.

## 4 Mounting

### 4.1 General instructions

#### Switch off source

The source container is part of the measuring system. In case the source container is already equipped with an active isotope, the source container must be locked before mounting.



#### Danger:

Before mounting; make sure that the source is securely closed. Use a padlock to secure the source container in the closed condition and prevent it from being inadvertently opened.

#### Protection against moisture

Protect your instrument against moisture ingress through the following measures:

- Use a suitable connection cable (see chapter " *Connecting to power supply* ")
- Tighten the cable gland or plug connector
- Lead the connection cable downward in front of the cable entry or plug connector

This applies mainly to outdoor installations, in areas where high humidity is expected (e.g. through cleaning processes) and on cooled or heated vessels.



#### Note:

Make sure that during installation or maintenance no moisture or dirt can get inside the instrument.

To maintain the housing protection, make sure that the housing lid is closed during operation and locked, if necessary.

#### Process conditions



#### Note:

For safety reasons, the instrument must only be operated within the permissible process conditions. You can find detailed information on the process conditions in chapter " *Technical data* " of the operating instructions or on the type label.

Hence make sure before mounting that all parts of the instrument exposed to the process are suitable for the existing process conditions.

These are mainly:

- Active measuring component
- Process fitting
- Process seal

Process conditions in particular are:

- Process pressure
- Process temperature
- Chemical properties of the medium
- Abrasion and mechanical influences

**Cable glands****Metric threads**

In the case of instrument housings with metric thread, the cable glands are screwed in at the factory. They are sealed with plastic plugs as transport protection.

You have to remove these plugs before electrical connection.

**NPT thread**

In the case of instrument housings with self-sealing NPT threads, it is not possible to have the cable entries screwed in at the factory. The free openings for the cable glands are therefore covered with red dust protection caps as transport protection.

Prior to setup you have to replace these protective caps with approved cable glands or close the openings with suitable blind plugs.

The suitable cable glands and blind plugs come with the instrument.

**4.2 Mounting instructions****Installation position****Note:**

During the planning, our specialists will analyse the conditions of the measurement loop to dimension the isotope accordingly.

You get a "Source Sizing" document specifying the required source activity and containing all relevant mounting information for your measuring point.

You must follow the instructions in this "Source Sizing" document in addition to the following mounting instructions.

The following mounting information is applicable as long as there is nothing else specified in the "Source Sizing" document.

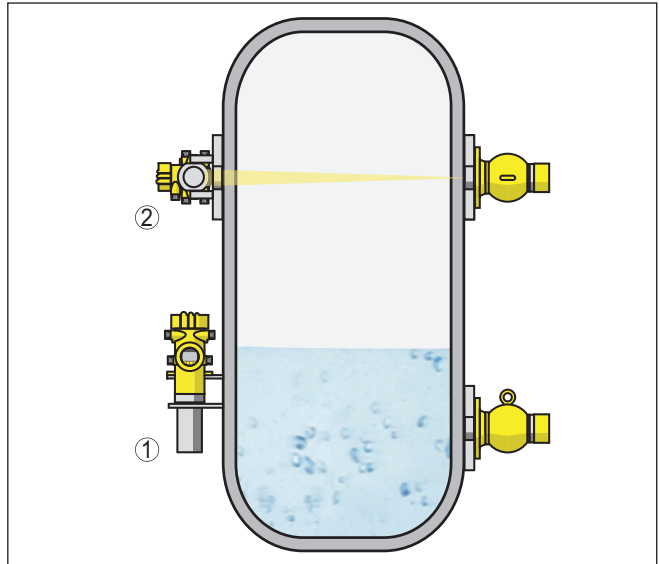

Fig. 4: Mounting position - level detection - version with detector tube

- 1 Vertical mounting
- 2 Mounting horizontally, at right angles to container

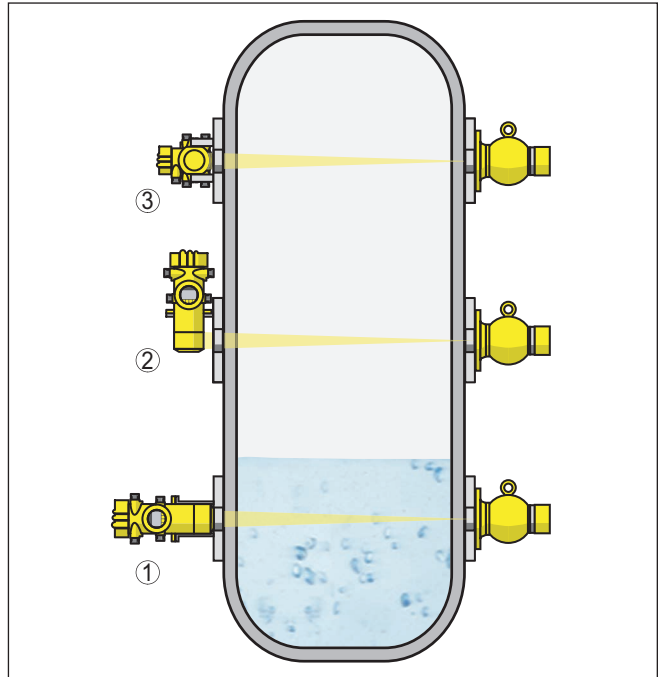

Fig. 5: Mounting position - level detection - version without detector tube

- 1 Horizontal mounting
- 2 Vertical mounting
- 3 Mounting horizontally, at right angles to container

You can find information on protective barriers and the mounting of the corresponding source container in the operating instructions manual of the source container, e.g. VEGASOURCE.

For level detection, the device is generally mounted horizontally at the height of the requested limit level. Make sure that there are no struts or reinforcements at this position in the vessel.

Direct the exit beam of the source container exactly towards the measuring range of POINTRAC 31.

Fasten the devices in such a way that it cannot fall out of the holder. If necessary, provide the device with a support from below.

Mount the source container as close as possible to the vessel. If there are gaps, secure the area with a safety fence and protective grating so that no one can reach into the dangerous area.

### Mounting clamp

You can mount the device (version with detector tube) with the attached mounting clamp to your vessel.



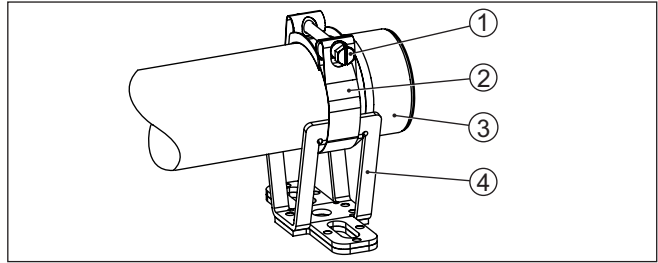

Fig. 6: Mounting clamp

- 1 Screw M8 x 80
- 2 Hinge bolt clamp
- 3 Detector tube
- 4 Console

1. Determine the exact mounting position of the mounting clamp and mark the holes.  
Drill appropriate holes (max. M12) for fastening the mounting clamps.
2. For mounting, insert the detector tube (3) into the V-shape holding fixture of the console (4).  
Draw the hinge bolt clamp (2) according to the illustration through the console (4).  
Screw the hinge bolt clamp (2) together and tighten the screw (1) with a max. torque of 20 Nm (14.75 lbf/ft).



**Note:**

The mounting clamps do not come with fastening screws. Use fastening elements that are appropriate for the situation in your plant.

**Sensor orientation**

**Level detection - max. detection**

The POINTRAC 31 is suitable for level detection in liquids or bulk solids. It is mounted at the height of the requested switching point.

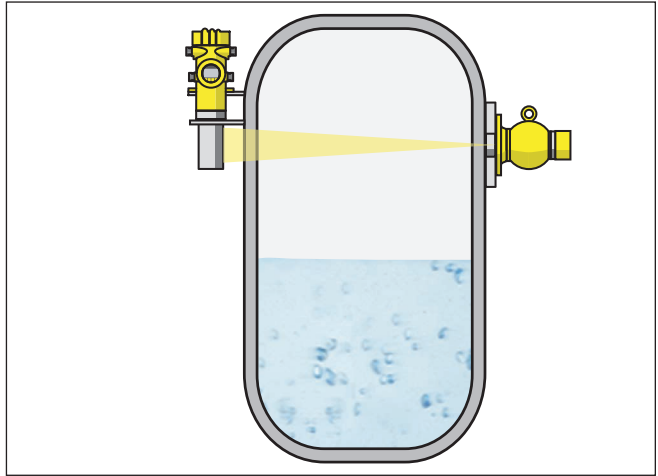

Fig. 7: POINTRAC 31 as max. level detection (uncovered)

**Level detection - min. detection**

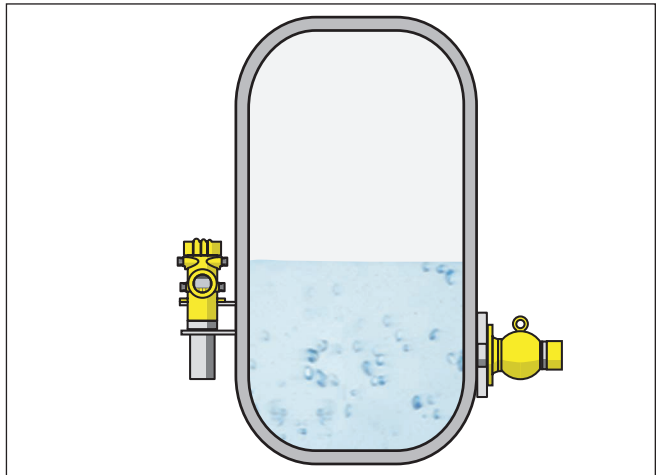

Fig. 8: POINTRAC 31 as min. level detection (covered)

### Bulk solids with low density

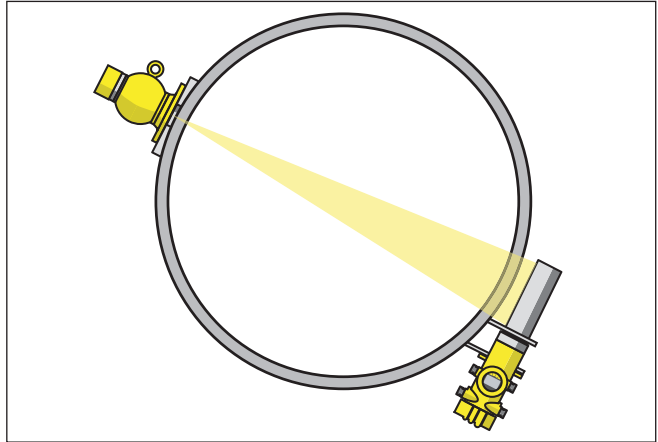

Fig. 9: POINTRAC 31 as level detection (top view)

POINTRAC 31 lends itself well for level detection of bulk solids with low density. Mount the instrument horizontally at the height of the requested switching point.

Mount the source container VEGASOURCE displaced by 90° in order to get the widest possible radiation angle.

When the sensor is covered by the medium, the radiation damping is considerably stronger - hence, the switching point is all the more reliable.

### Protection against heat

If the max. ambient temperature is exceeded, you must take suitable measures to protect the instrument against overheating.

You can protect the instrument by providing a suitable insulation against the heat or mounting the instrument further away from the heat source.

Make sure these measures are taken into account already in the planning stage. If you want to carry out such measures later on, contact our specialists to ensure that the accuracy of the application is not impaired.

If these measures are not sufficient to maintain the max. ambient temperature, you could consider using the water or air cooling system we offer for POINTRAC 31.

The cooling system must also be included in the calculations for the measuring point. Contact our specialists regarding the dimensioning of the cooling.

## 5 Connecting to power supply

### 5.1 Preparing the connection

#### Safety instructions

Always keep in mind the following safety instructions:

- The electrical connection must only be carried out by trained, qualified personnel authorised by the plant operator.
- If overvoltage surges are expected, overvoltage arresters should be installed.



#### Warning:

Only connect or disconnect in de-energized state.

#### Voltage supply via mains voltage

In this case, the instrument is designed in protection class I. To maintain this protection class, it is absolutely necessary that the ground conductor be connected to the internal ground terminal. Take note of the national installation regulations.

Supply voltage and current output are carried on separate connection cables if reliable separation is required. The supply voltage range can differ depending on the instrument version.

The data for power supply are specified in chapter " *Technical data*".

#### Select connection cable

##### General requirements

- Make sure that the cable used has the required temperature resistance and fire safety for max. occurring ambient temperature
- Use cable with round cross section for instruments with housing and cable gland. To ensure the seal effect of the cable gland (IP protection rating), find out which cable outer diameter the cable gland is suitable for.
- Use a cable gland fitting the cable diameter.
- Unused cable glands do not offer sufficient protection against moisture and must be replaced by blind plugs.

##### Voltage supply

For power supply, an approved, three-wire installation cable with PE conductor is required.

##### Signal cable

The 8/16 mA current output is connected with standard two-wire cable without shielding. If electromagnetic interference is expected which is above the test values of EN 61326 for industrial areas, shielded cable should be used.

#### Cable glands

##### Metric threads

In the case of instrument housings with metric thread, the cable glands are screwed in at the factory. They are sealed with plastic plugs as transport protection.

You have to remove these plugs before electrical connection.

##### NPT thread

In the case of instrument housings with self-sealing NPT threads, it is not possible to have the cable entries screwed in at the factory. The

free openings for the cable glands are therefore covered with red dust protection caps as transport protection.

Before setup you have to replace these protective caps with approved cable glands or close the openings with suitable blind plugs. Unused cable glands do not provide sufficient protection against moisture and must be replaced with blind plugs.

The suitable cable glands and blind plugs come with the instrument.

### Cable screening and grounding

If shielded cable is required, connect the cable screen on both ends to ground potential. In the sensor, the screen must be connected directly to the internal ground terminal. The ground terminal on the outside of the housing must be connected to the potential equalisation (low impedance).

If potential equalisation currents are expected, the connection on the processing side must be made via a ceramic capacitor (e. g. 1 nF, 1500 V). The low-frequency potential equalisation currents are thus suppressed, but the protective effect against high frequency interference signals remains.



#### Warning:

Significant potential differences exist inside galvanization plants as well as on vessels with cathodic corrosion protection. Considerable equalisation currents can flow over the cable screen if the screen is grounded on both ends.

To avoid this, the cable screen in such applications must be connected only on one end to ground potential in the switching cabinet. The cable screen must **not** be connected to the inner ground terminal in the sensor and the outer ground terminal on the housing must **not** be connected to potential equalization!



#### Information:

The metal parts of the instrument are conductively connected to the inner and outer ground terminal on the housing. This connection is either a direct metallic connection or, in case of instruments with external electronics, a connection via the screen of the special connection cable.

You can find specifications on the potential connections inside the instrument in chapter "*Technical data*".

### Connection technology

The voltage supply and signal output are connected via the spring-loaded terminals in the housing.

Connection to the display and adjustment module or to the interface adapter is carried out via contact pins in the housing.

### Connection procedure

Proceed as follows:

The procedure applies to instruments without explosion protection.

1. Unscrew the big housing cover
2. Loosen compression nut of the cable gland and remove blind plug

3. Remove approx. 10 cm (4 in) of the cable mantle, strip approx. 1 cm (0.4 in) of insulation from the ends of the individual wires
4. Insert the cable into the sensor through the cable entry

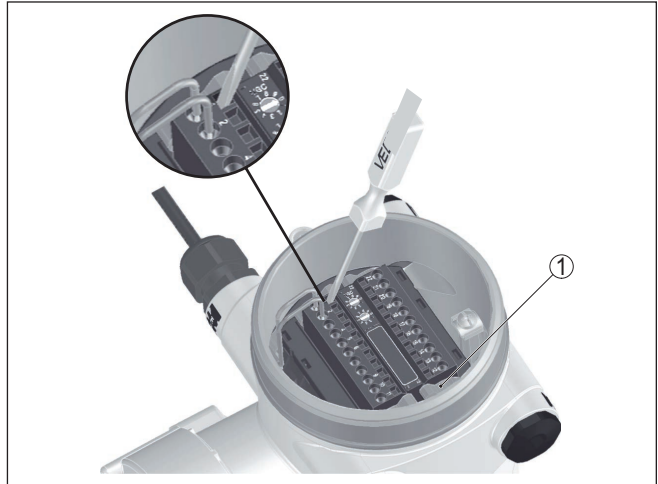

Fig. 10: Connection steps 4 and 5

1 Locking of the terminal blocks

5. Insert a small slotted screwdriver firmly into the rectangular lock openings of the respective connection terminal
6. Insert the wire ends into the round openings of the terminals according to the wiring plan



#### Information:

Solid cores as well as flexible cores with cable end sleeves are inserted directly into the terminal openings. In case of flexible cores without end sleeves, press the rectangular lock opening with a small screwdriver; the terminal opening is freed. When the screwdriver is released, the terminal opening closes again.

7. Check the hold of the wires in the terminals by lightly pulling on them  
To loosen a line, insert a small slotted screwdriver firmly into the rectangular lock opening according to the illustration
8. Connect the shielding to the internal ground terminal, connect the external ground terminal to potential equalisation
9. Tighten the compression nut of the cable entry gland. The seal ring must completely encircle the cable
10. Screw the housing lid back on

The electrical connection is finished.



#### Information:

The terminal blocks are pluggable and can be detached from the electronics. To do this, loosen the two lateral locking levers of the terminal block with a small screwdriver. When loosening the locking,

the terminal block is automatically squeezed out. It must snap in place when re-inserted.

## 5.2 Connection

### Non-Ex instruments and instruments with non-intrinsically safe current output

#### Electronics and connection compartment - Non-Ex instruments and instruments with non-intrinsically safe current output

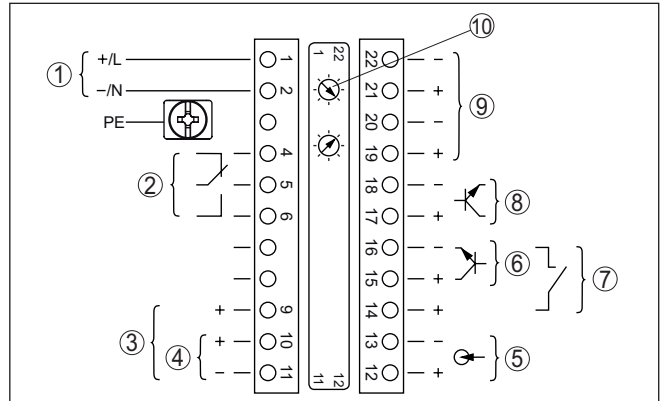

Fig. 11: Electronics and connection compartment with non-Ex instruments and instruments with non-intrinsically safe current output

- 1 Voltage supply
- 2 Relay output
- 3 Signal output 8/16 mA/HART active
- 4 Signal output 8/16 mA/HART Multidrop passive
- 5 Signal input 4 ... 20 mA
- 6 Switching input for NPN transistor
- 7 Switching input floating
- 8 Transistor output
- 9 Interface for sensor-sensor communication (MGC)
- 10 Setting the bus address for sensor-sensor communication (MGC)<sup>2)</sup>

#### Adjustment and connection compartment - Non-Ex instruments and instruments with non-intrinsically safe current output

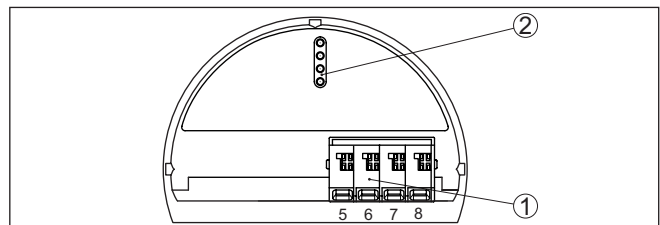

Fig. 12: Adjustment and connection compartment with non-Ex instruments and instruments with non-intrinsically safe current output

- 1 Terminals for the external display and adjustment unit
- 2 Contact pins for the display and adjustment module or interface adapter

<sup>2)</sup> MGC = Multi Gauge Communication

### Connection to a PLC

If inductive loads or stronger currents are switched through, the gold plating on the relay contact surface will be permanently damaged. The contact is then no longer suitable for switching low-voltage circuits.

Inductive loads also result from the connection to a PLC input or output and/or in combination with long cables. It is imperative that you take measures to extinguish sparks to protect the relay contact (e.g. Z diode) or the transistor or 8/16 mA output.

### Instruments with intrinsically safe current output



You can find detailed information on the explosion-protected versions (Ex-ia, Ex-d) in the Ex-specific safety instructions. These safety instructions are part of the scope of delivery and come with the Ex-approved instruments.

### Electronics and connection compartment - Instruments with intrinsically safe current output

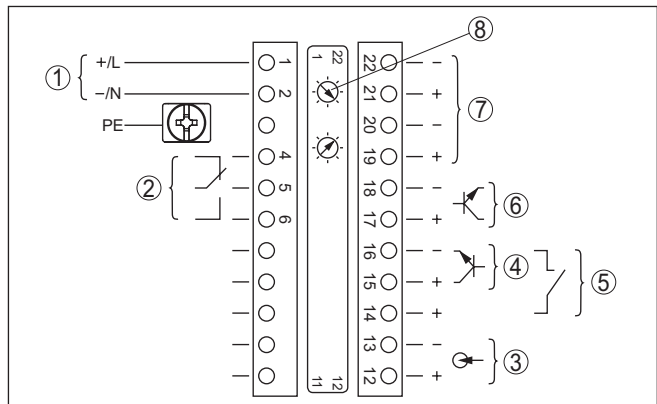

Fig. 13: Electronics and connection compartment (Ex-d) with instruments with intrinsically safe current output

- 1 Voltage supply
- 2 Relay output
- 3 Signal input 4 ... 20 mA
- 4 Switching input for NPN transistor
- 5 Switching input floating
- 6 Transistor output
- 7 Interface for sensor-sensor communication (MGC)
- 8 Setting the bus address for sensor-sensor communication (MGC)<sup>3)</sup>

<sup>3)</sup> MGC = Multi Gauge Communication



**Adjustment and connection compartment - Instruments with intrinsically safe current output**

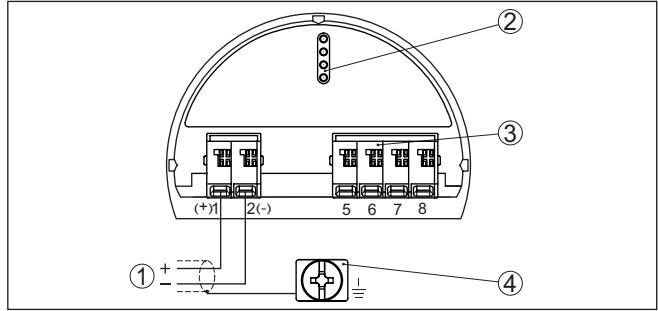

Fig. 14: Adjustment and connection compartment (Ex-ia) with instruments with intrinsically safe current output

- 1 Terminals for intrinsically safe signal output 8/16 mA/HART (Multidrop) active
- 2 Contact pins for the display and adjustment module or interface adapter
- 3 Terminals for the external display and adjustment unit
- 4 Ground terminal

**Connection to a PLC**

If inductive loads or stronger currents are switched through, the gold plating on the relay contact surface will be permanently damaged. The contact is then no longer suitable for switching low-voltage circuits.

Inductive loads also result from the connection to a PLC input or output and/or in combination with long cables. It is imperative that you take measures to extinguish sparks to protect the relay contact (e.g. Z diode) or the transistor or 8/16 mA output.

## 6 Set up with the display and adjustment module

### Mount/dismount display and adjustment module

### 6.1 Insert display and adjustment module

The display and adjustment module can be inserted into the sensor and removed again at any time. It is not necessary to interrupt the voltage supply.

Proceed as follows:

1. Unscrew the small housing cover
2. Place the display and adjustment module in the desired position on the electronics (you can choose any one of four different positions - each displaced by 90°)
3. Press the display and adjustment module onto the electronics and turn it to the right until it snaps in
4. Screw housing lid with inspection window tightly back on

Disassembly is carried out in reverse order.

The display and adjustment module is powered by the sensor, an additional connection is not necessary.

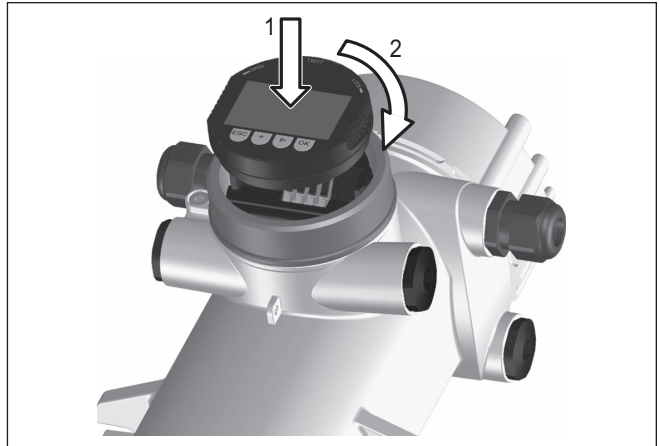

Fig. 15: Insert display and adjustment module



#### Note:

If you intend to retrofit the instrument with a display and adjustment module for continuous measured value indication, a higher lid with an inspection glass is required.

## 6.2 Adjustment system

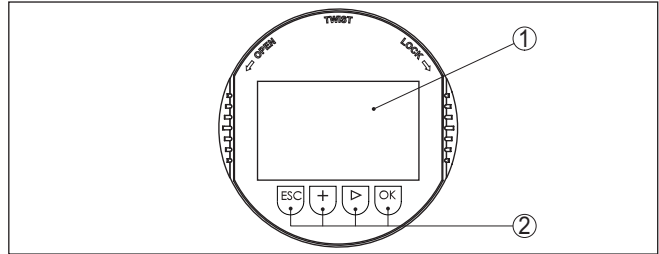

Fig. 16: Display and adjustment elements

- 1 LC display
- 2 Adjustment keys

### Key functions

- **[OK]** key:
  - Move to the menu overview
  - Confirm selected menu
  - Edit parameter
  - Save value
- **[>]** key:
  - Change measured value presentation
  - Select list entry
  - Select menu items
  - Select editing position
- **[+]** key:
  - Change value of the parameter
- **[ESC]** key:
  - Interrupt input
  - Jump to next higher menu

### Operating system - Keys direct

The instrument is operated via the four keys of the display and adjustment module. The individual menu items are shown on the LC display. You can find the function of the individual keys in the previous illustration.

### Adjustment system - keys via magnetic pen

With the Bluetooth version of the display and adjustment module you can also adjust the instrument with the magnetic pen. The pen operates the four keys of the display and adjustment module right through the closed lid (with inspection window) of the sensor housing.

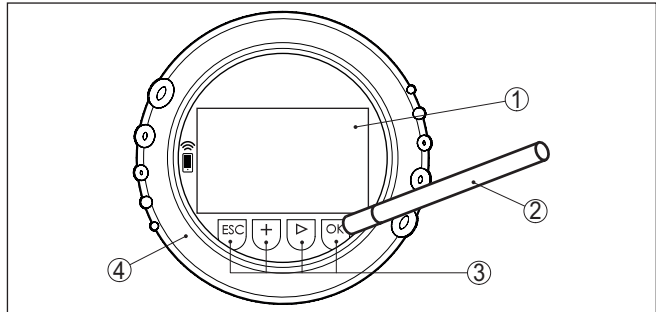

Fig. 17: Display and adjustment elements - with adjustment via magnetic pen

- 1 LC display
- 2 Magnetic pen
- 3 Adjustment keys
- 4 Lid with inspection window

## Time functions

When the **[+]** and **[->]** keys are pressed quickly, the edited value, or the cursor, changes one value or position at a time. If the key is pressed longer than 1 s, the value or position changes continuously.

When the **[OK]** and **[ESC]** keys are pressed simultaneously for more than 5 s, the display returns to the main menu. The menu language is then switched over to "English".

Approx. 60 minutes after the last pressing of a key, an automatic reset to measured value indication is triggered. Any values not confirmed with **[OK]** will not be saved.

## 6.3 Parameter adjustment

The instrument is adapted to the application conditions via the parameter adjustment. The parameter adjustment is carried out with an adjustment menu.

## Main menu

The main menu is divided into five sections with the following functions:

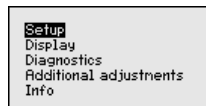

**Setup:** Settings, e.g. for measurement loop name, isotope, application, background radiation, adjustment, signal output

**Display:** Settings, for example language, measured value display

**Diagnostics:** Information, for example, of device status, peak value, simulation

**Additional adjustments:** Instrument unit, reset, date/time, copying function

**Info:** Instrument name, hardware and software version, date of manufacture, instrument features

**Procedure**

Check if the correct language is already set for the display. If not, you can change the language in the menu item "*Display - Menu language*".

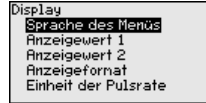
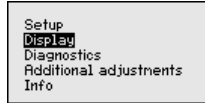

Start with the setup of POINTRAC 31.

In the main menu item "*Setup*", the individual submenu items should be selected one after the other and provided with the correct parameters to ensure optimum adjustment of the measurement. The procedure is described in the following.

Stick with the normal sequence of the menu items as closely as possible.

**6.3.1 Setup**

**Measurement loop name**

In this menu item you can assign an unambiguous name to the sensor or measurement loop. Push the "**OK**" key to start the editing. With the "+" key you change the sign and with the "->" key you jump to the next position.

You can enter names with max. 19 characters. The character set comprises:

- Capital letters from A ... Z
- Numbers from 0 ... 9
- Special characters + - / \_ blanks

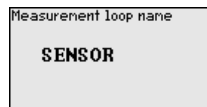

**Isotope**

In this menu item you can adjust the POINTRAC 31 to the isotope installed in the source container.

For this purpose, check which isotope is in the source container. You can find this information on the type label of the source container.

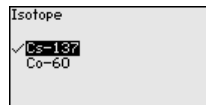
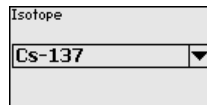

Through this selection, the sensitivity of the sensor is adapted perfectly to the isotope. The normal reduction of source activity through radioactive decay is thus taken into account.

The POINTRAC 31 requires this information for the automatic decay compensation. This ensures error-free measurement over the entire lifetime of the gamma emitter - an annual recalibration is not necessary.

Enter the requested parameters via the appropriate keys, save your settings with [**OK**] and jump to the next menu item with the [**ESC**] and the [**->**] key.

**Application**

Enter here, the respective application.

This menu item enables adaptation of the sensor to the requested application. You can choose between the following applications: "Level", "X-ray alarm" or "Real value correction".

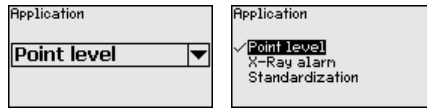
**X-ray alarm**

The radiation of external radiation sources can influence the measuring result of continuously measuring, radiometric sensors.

You can also use the POINTRAC 31 as a secondary instrument for detection against X-ray alarm. Hence an alarm can be triggered.

For this function you require PACTware with the respective DTM.

**Real value correction**

You can also use the POINTRAC 31 as a Secondary instrument for detection of a defined level. Hence you can automatically correct the measured value of a continuously measuring, radiometric sensor to the real value when this level is reached.

For this function you require PACTware with the respective DTM.

**Background radiation**

The natural radiation on earth influences the accuracy of the measurement.

With this menu item the natural background radiation can be faded out.

For this purpose, the POINTRAC 31 measures the natural background radiation and sets the pulse rate to zero.

In the future, the pulse rate from this background radiation will be automatically deducted from the total pulse rate. This means: only the component of the pulse rate originating from the source will be displayed.

The source container must be closed for this setting.

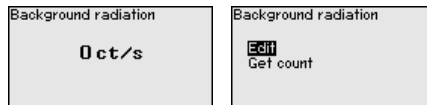
**Unit**

In this menu item you can select the temperature unit.

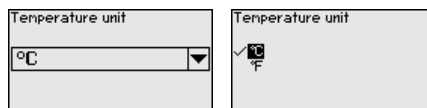
**Adjustment mode**

in this menu item you can select if you want to carry out a single or double point adjustment on the sensor.

With the double point adjustment, the Delta I value is selected automatically.

We recommend selecting the double point adjustment. To use this, you must be able to change the level of the vessel so as to carry out the adjustment of the sensor with full status (covered) and with empty status (uncovered).

Hence, you will get a very reliable switching point.

With single point adjustment, you have to define the difference between the min. and max. adjustment points (Delta I) yourself during the following setup.

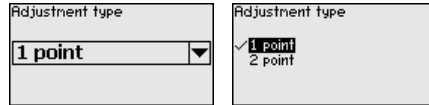

**Adjustment "uncovered" (single point adjustment)**

This menu item appears only if you have selected "**Single point adjustment**" as adjustment mode (Setup - Adjustment mode).

In this menu item you determine the point at which the POINTRAC 31 should switch in uncovered status.

Empty the vessel until the sensor is uncovered.

For this enter the requested pulse rate manually or let the rate be determined by POINTRAC 31. Automatic determination of the pulse rate should be given preference.

The count rate is stated in ct/s. This is the number of counts per second, i.e. the measured radioactive radiation dose actually reaching the sensor.

Prerequisites:

- Radiation is switched on - Source container is set to "ON"
- There is no medium between source container and sensor

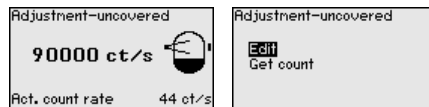

You can enter the value for "Adjustment uncovered" (ct/s) manually.

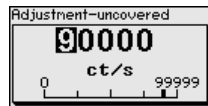

You can have the value for "Adjustment uncovered" determined by POINTRAC 31.



**Delta I (single point adjustment)**

This menu item appears only if you have selected "**Single point adjustment**" as adjustment mode (Setup - Adjustment mode).

In this menu item you can adjust at which percentage value of the max. pulse rate the sensor should switch over.

Since in most cases the radiation is almost completely absorbed when the sensor is covered, the pulse rate when the sensor is covered is very low.

The change between the two statuses is sufficiently clear.

Hence a percentage value of 90 % for the Delta I value is recommended.

You select lower values for sensitive detection of material cones or buildup which cause only partial absorption of the radiation.



### Adjustment "covered" (two-point adjustment)

This menu item appears only if you have selected "**Two point adjustment**" as adjustment mode (Setup - Adjustment mode).

In this menu item you can set the min. pulse rate (ct/s) at which the sensor should switch over.

Fill the vessel until the POINTRAC 31 is covered.

You thus get the min. pulse rate (ct/s) for the "covered" adjustment.

Enter the requested pulse rate manually or let the rate be determined by POINTRAC 31. Automatic determination of the pulse rate should be given preference.

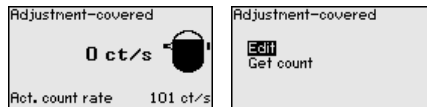

You can enter the adjustment point (ct/s) manually.

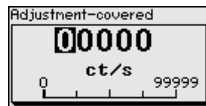

You can let the adjustment point be determined by POINTRAC 31.



### Adjustment "uncovered" (two-point adjustment)

This menu item appears only if you have selected "**Two point adjustment**" as adjustment mode (Setup - Adjustment mode).

In this menu item you can set the max. pulse rate (ct/s) at which the sensor should switch over.

Empty the vessel until the POINTRAC 31 is uncovered.

You thus get the max. pulse rate (ct/s) for the "uncovered" adjustment.

Enter the requested pulse rate manually or let the rate be determined by POINTRAC 31. Automatic determination of the pulse rate should be given preference.



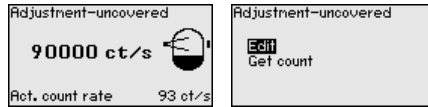

You can enter the adjustment point (ct/s) manually.

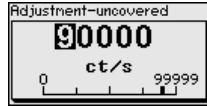

You can let the adjustment point be determined by POINTRAC 31.



**Current output mode**

In this menu item you can select the switching behaviour of the sensor.

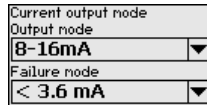

You can choose between an 8 - 16 mA characteristics or a 16 - 8 mA characteristics.

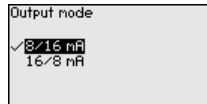

In this menu item you can also define the switching behaviour in case of fault. You can select if the current output should output 22 mA or < 3.6 mA in case of fault.

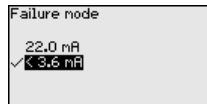

**Relay**

In this menu item you can select which mode the sensor should operate in.

You can choose between overfill and dry run protection.

The relay outputs of the sensor react accordingly.

Overfill protection = the relay will deenergise (safe state) when the max. level is reached.

Dry run protection = the relay will deenergise (safe state) when the min. level is reached.

Make sure that you have selected the correct characteristics. See menu item "Setup - Current output mode".

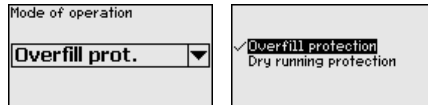

### Lock/Unlock adjustment

In the menu item "Lock/unlock adjustment", you can protect the sensor parameters against unauthorized or inadvertent modification. The sensor is locked/unlocked permanently.

With locked instrument, only the following adjustment functions are possible without entering a PIN:

- Select menu items and show data
- Read data from the sensor into the display and adjustment module



Before you lock the sensor in unlocked condition, you can modify the four-digit PIN number.

Keep the entered PIN number in mind. Operation of the sensor is only possible with this PIN number.



#### Caution:

When the PIN is active, adjustment via PACTware/DTM as well as other systems is also blocked.

In delivery status, the PIN is **0000**.

Call our service department if you have modified and forgotten the PIN.

### 6.3.2 Display

In the main menu point "Display", the individual submenu points should be selected one after the other and provided with the correct parameters to ensure the optimum adjustment of the display. The procedure is described in the following.

#### Menu language

This menu item enables the setting of the requested national language.

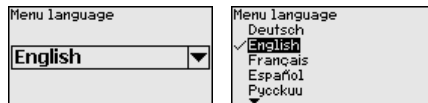

In delivery status, the sensor is set to the ordered national language.

If no language is preset, you will be asked during setup.

#### Displayed value

With this parameter you can change the indication of the display.

You can choose if the display should show the actual pulse rate or the electronics temperature.

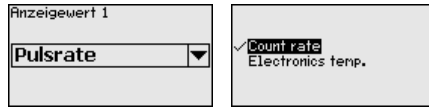

### 6.3.3 Diagnostics

#### Sensor status

In this menu item, you can enquire the status of your sensor. In normal operation, the sensor displays the message "OK". In case of fault, you will find the corresponding fault code here.

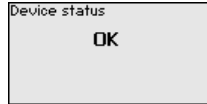

#### Peak value indicator

The peak value function holds the max. and min. values during operation.

- Pulse rates - min./max.
- Temperature - min./max./actually

Peak values	
Pulse/sec. min.	0ct/s
Pulse/sec. max.	35467ct/s
T <sub>-min.</sub>	21,5 °C
T <sub>-max.</sub>	31,5 °C
T <sub>-act.</sub>	31,0 °C

#### Adjustment data

Here, you can retrieve the adjustment value of the sensor. This is the percentage value of the max. pulse rate at which the sensor switches over.

If you have carried out a single point adjustment, this is the entered value. With a two-point adjustment, this is the calculated value.

The value is an indication for the reliability and non-repeadability of the switching point.

The greater the difference in the pulse rate between covered and uncovered status, the greater the differential value (Delta I) and the more reliable the measurement. The automatically calculated damping is also oriented around the Delta I value. The higher the value, the lower the damping.

A Delta I value below 10 % is an indication for a critical measurement.

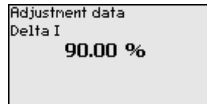

#### Simulation

In this menu item you can simulate measured values via the current output. This allows the signal path to be tested, e.g. through downstream indicating instruments or the input card of the control system.

You can simulate different values:

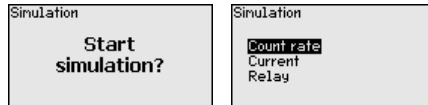

Pulse rate of the sensor

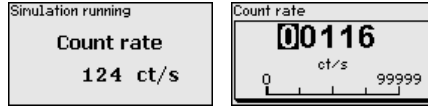

Current output

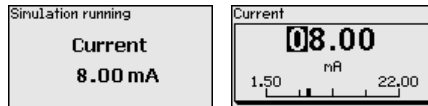

Switching function of the relay

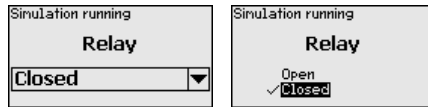

#### Information:

The simulation is automatically terminated 10 minutes after the last pressing of a key.

#### Calculated damping

The sensor calculates a suitable integration time automatically.

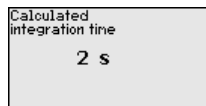

### 6.3.4 Additional adjustments

#### Date/Time



In this menu item you can set the actual date, time and display format.

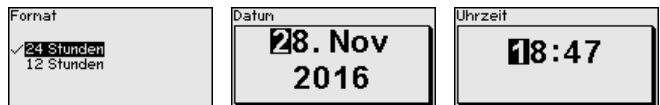

#### Reset

When a reset is carried out, all settings (with only a few exceptions) are reset. The exceptions are: PIN, language, SIL and HART mode.

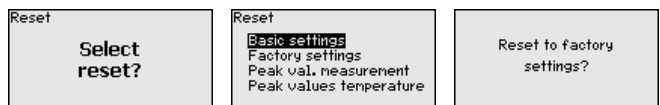

The following reset functions are available:

**Basic settings:** Resetting of the parameter adjustments to default values at the time of shipment. Order-specific settings are deleted.

**Default settings:** Resetting of the parameter adjustment like under "*Basic settings*". In addition, special parameters are reset to default values. Order-specific settings are deleted.

**Peak values of measured value:** Resetting of the parameter adjustments in the menu item "*Setup*" to the default values of the respective instrument. Order-specific settings remain but are not taken over into the current parameters.

**Peak values of temperature:** Resetting of the measured min. and max. temperatures to the actual measured value.

The following table shows the default values of the instrument. The values apply for the application "*Limit level*". First of all you have to select the application.

Depending on the instrument version, not all menu items may be available or they may be differently assigned:

Menu	Menu item	Default value
Setup	Measurement loop name	Sensor
	Isotope	Cs-137
	Application	Limit level
	Adjustment mode	Single point adjustment
	Adjustment - uncovered	90000 ct/s
	Adjustment - covered	9000 ct/s only with two-point adjustment
	Delta I	90 %
	Background radiation	0 ct/s
	Temperature unit	°C
	Damping	Is calculated automatically by the instrument
	Current output mode	8/16 mA, < 3.6 mA
	X-ray alarm	Modulated measuring current
	Mode - Relay	Overfill protection
Lock adjustment	Released	
Display	Language	Selected language
	Displayed value	Pulse rate
Additional adjustments	Temperature unit	°C
	HART mode	Standard

**HART mode**

With this function you can select the mode.

The sensor offers the HART modes standard and multidrop.

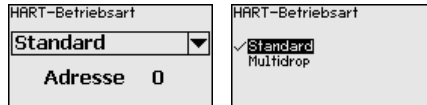

The default setting is standard with address 0.

If the measured value is output via the 4 ... 20 mA output, you must not switch over to HART Multidrop.

The mode 'Standard', with fixed address 0 (factory setting), means output of the measured value as 8/16 mA signal.

In Multidrop mode, several sensors are communicating on one two-wire cable via the HART protocol.

In Multidrop mode, up to 15 sensors can be operated on one two-wire cable. An address between 1 and 15 must be assigned to each sensor.

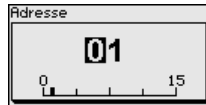

### Copy instrument settings

With this function

- Load parameter adjustment data from the sensor into the display and adjustment module
- Write parameter adjustment data from the display and adjustment module into the sensor

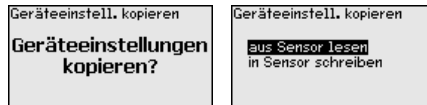

The copied data are permanently saved in an EEPROM memory in the display and adjustment module and remain there even in case of a power failure. From there, they can be written into one or more sensors or kept as backup for a possible sensor exchange.



#### Note:

Before the data are copied into the sensor, a check is carried out to determine if the data fit the sensor. If the data do not fit, a fault signal is triggered. When data are being written into the sensor, the display shows which instrument type the data originate from and which TAG number this sensor had.

### 6.3.5 Info

#### Info

In this menu you will find the following menu items:

- Instrument name - shows instrument name and serial number
- Instrument version - shows hardware and software version of the instrument
- Date of manufacture - shows calibration date and the date of the last change
- Instrument features - shows further instrument features, such as e.g. approval, electronics ...

Examples for info display:

Softwareversion <b>2.0.1</b> Hardwareversion <b>1.06</b>	Kalibrierdatum <b>3. April 2013</b> Letzte Änderung <b>4. Nov 2016</b>	Geräteerkmale Housing / Protection Aluminium / IP66/IP67
---	---	--

### 6.4 Saving the parameterisation data

**On paper**

We recommend writing down the adjustment data, e.g. in this operating instructions manual, and archiving them afterwards. They are thus available for multiple use or service purposes.

**In the display and adjustment module**

If the instrument is equipped with a display and adjustment module, the parameter adjustment data can be saved therein. The procedure is described in menu item "*Copy device settings*".

## 7 Setup with PACTware

### 7.1 Connect the PC

Via the interface adapter directly on the sensor

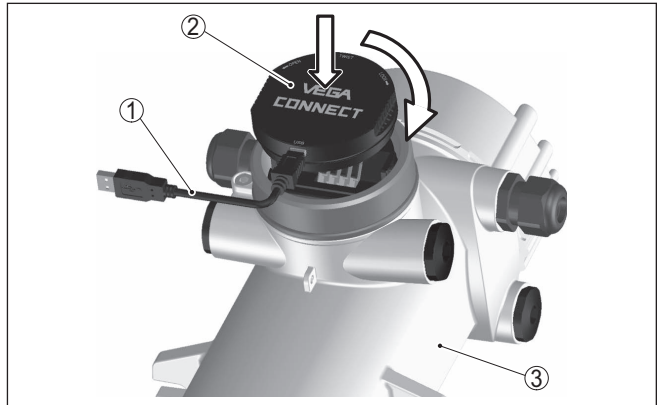

Fig. 18: Connection of the PC directly to the sensor via the interface adapter

- 1 USB cable to the PC
- 2 Interface adapter VEGACONNECT 4
- 3 Sensor



#### Information:

The interface adapter VEGACONNECT 3 is not suitable for connection to the sensor.

#### Connection via HART

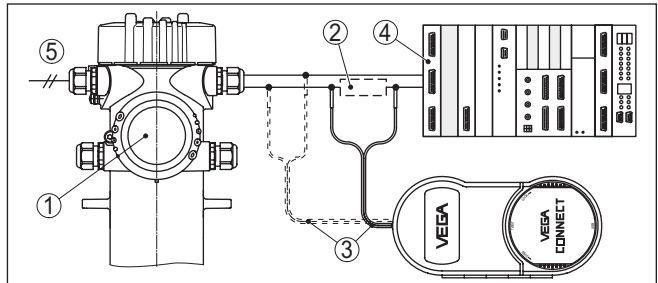

Fig. 19: Connecting the PC via HART to the signal cable

- 1 POINTRAC 31
- 2 HART resistance 250  $\Omega$  (optional depending on evaluation)
- 3 Connection cable with 2 mm pins and terminals
- 4 Processing system/PLC/Voltage supply
- 5 Voltage supply

#### Necessary components:

- POINTRAC 31
- PC with PACTware and suitable VEGA DTM
- VEGACONNECT 4
- HART resistance approx. 250  $\Omega$



- Voltage supply

**Note:**

With power supply units with integrated HART resistance (internal resistance approx. 250  $\Omega$ ), an additional external resistance is not necessary. This applies, e.g. to the VEGA instruments VEGATRENN 149A, VEGAMET 381 and VEGAMET 391). Commercially available Ex separators are also usually equipped with sufficient current limitation resistance. In such cases, VEGACONNECT 4 can be connected parallel to the 4 ... 20 mA cable.

## 7.2 Parameter adjustment with PACTware

### Prerequisites

For parameter adjustment of the sensor via a Windows PC, the configuration software PACTware and a suitable instrument driver (DTM) according to FDT standard are required. The up-to-date PACTware version as well as all available DTMs are compiled in a DTM Collection. The DTMs can also be integrated into other frame applications according to FDT standard.

**Note:**

To ensure that all instrument functions are supported, you should always use the latest DTM Collection. Furthermore, not all described functions are included in older firmware versions. You can download the latest instrument software from our homepage. A description of the update procedure is also available in the Internet.

Further setup steps are described in the operating instructions manual "*DTM Collection/PACTware*" attached to each DTM Collection and which can also be downloaded from the Internet. Detailed descriptions are available in the online help of PACTware and the DTMs.

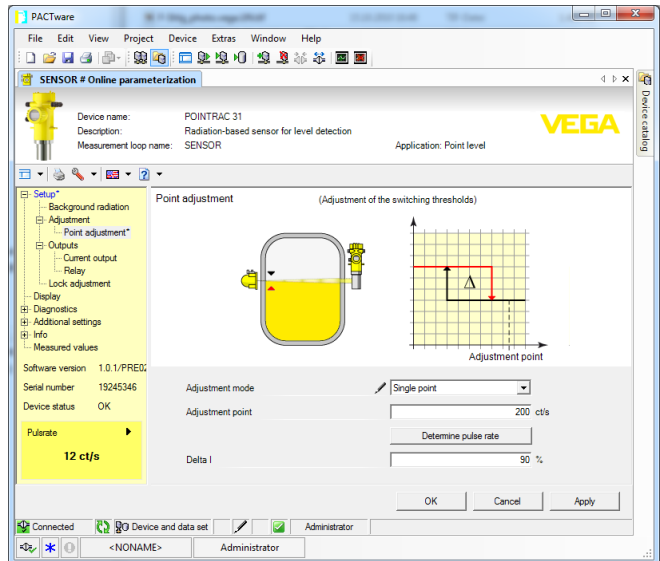

Fig. 20: Example of a DTM view

### Standard/Full version

All device DTMs are available as a free-of-charge standard version and as a full version that must be purchased. In the standard version, all functions for complete setup are already included. An assistant for simple project configuration simplifies the adjustment considerably. Saving/printing the project as well as import/export functions are also part of the standard version.

In the full version there is also an extended print function for complete project documentation as well as a save function for measured value and echo curves. In addition, there is a tank calculation program as well as a multiviewer for display and analysis of the saved measured value and echo curves.

The standard version is available as a download under [www.vega.com/downloads](http://www.vega.com/downloads) and "Software". The full version is available on CD from the agency serving you.

### 7.3 Saving the parameterisation data

We recommend documenting or saving the parameterisation data via PACTware. That way the data are available for multiple use or service purposes.

## 8 Set up with other systems

### 8.1 DD adjustment programs

Device descriptions as Enhanced Device Description (EDD) are available for DD adjustment programs such as, for example, AMS™ and PDM.

The files can be downloaded at [www.vega.com/downloads](http://www.vega.com/downloads) under "*Software*".

### 8.2 Field Communicator 375, 475

Device descriptions for the instrument are available as EDD for parameterisation with Field Communicator 375 or 475.

Integrating the EDD into the Field Communicator 375 or 475 requires the "Easy Upgrade Utility" software, which is available from the manufacturer. This software is updated via the Internet and new EDDs are automatically accepted into the device catalogue of this software after they are released by the manufacturer. They can then be transferred to a Field Communicator.

## 9 Diagnostics and servicing

### 9.1 Maintenance

If the device is used properly, no special maintenance is required in normal operation.

The corresponding source container must be checked in regular intervals. You can find further information in the operating instructions manual of the source container.

### 9.2 Status messages

The instrument features self-monitoring and diagnostics according to NE 107 and VDI/VDE 2650. In addition to the status messages in the following tables there are more detailed error messages available under the menu item "Diagnostics" via the respective adjustment module.

#### Status messages

The status messages are divided into the following categories:

- Failure
- Function check
- Out of specification
- Maintenance required

and explained by pictographs:

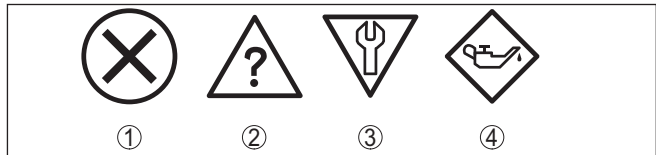

Fig. 21: Pictographs of the status messages

- 1 Failure - red
- 2 Out of specification - yellow
- 3 Function check - orange
- 4 Maintenance required - blue

**Failure:** Due to a malfunction in the instrument, a fault message is output.

This status message is always active. It cannot be deactivated by the user.

**Function check:** The instrument is being worked on, the measured value is temporarily invalid (for example during simulation).

This status message is inactive by default.

**Out of specification:** The measured value is unreliable because an instrument specification was exceeded (e.g. electronics temperature).

This status message is inactive by default.

**Maintenance required:** Due to external influences, the instrument function is limited. The measurement is affected, but the measured value is still valid. Plan in maintenance for the instrument because a failure is expected in the near future (e.g. due to buildup).

This status message is inactive by default.

**Failure**

<b>Code Text message</b>	<b>Cause</b>	<b>Rectification</b>
F008 Error multi sensor communication	Additional sensors not switched on EMC influences No other sensor available	Check wiring between the sensors Connect the sensors correctly and make them ready for operation
F013 Sensor signals a fault	Error on the current input/digital input No valid measured value Connected instruments without function	Check current input Check connected instruments (Secondary instrument)
F016 Adjustment data exchanged	Values of the min. and max. adjustment exchanged	Correct adjustment data
F017 Adjustment span too small	The values of the min. and max. adjustment are too close together	Correct adjustment data
F025 Invalid linearization table	Wrong or empty linearization table (1074, 1075, 1080, 1100, 1106) Wrong value in the linearization table (1143, 1144)	Create linearization table Correct linearization table
F030 Process value out of limits	Process values are not within the adjusted measuring range	Repeat adjustment
F034 EPROM hardware error	Electronics defective	Exchanging the electronics
F035 EPROM data error	Error in the internal instrument communication	Carry out a reset Exchanging the electronics
F036 Faulty program memory	Error during software update	Repeat software update Exchanging the electronics
F037 RAM hardware error	Error in RAM	Exchanging the electronics
F038 Secondary signals failure	Connection cable to the Secondary instrument interrupted Instrument not defined as Secondary instrument One of the Secondary instruments signals a failure	Check the connection cable to the Secondary instrument Define instrument as Secondary Check Secondary instruments
F040 Hardware error	Instrument defective (1092, 1126) Temperature outside the specification (1091)	Restart instrument Exchanging the electronics Cool the instrument or protect it with isolation material against heat/cold
F041 Photomultiplier error	Error in the measured value recording	Exchanging the electronics
F045 Error on the current output	Error on the current output	Check wiring of the current output Exchanging the electronics

Code Text message	Cause	Rectification
F052 Faulty configuration	Invalid parameter adjustment	Carry out a reset
F114 Error real time clock	Discharge accumulator	Readjust real time clock
F122 Double address on the multisensor communication bus	Instrument address was assigned several times	Change instrument addresses
F123 X-ray alarm	External instruments cause radiation Radiation above the max. adjustment value	Determine reason for X-ray alarm In case of brief X-ray radiation: Monitor switching outputs for this time manually
F124 Alarm due to increased radiation	Radiation dose too high	Determine reason for increased radiation
F125 Ambient temperature too high	Ambient temperature on the housing outside the specification	Cool (heat) the instrument or protect it with isolation material against cold or radiation heat
F126 Error in the trend recording	Instrument error	Call our service
F141 Communication error on the multisensor communication bus	Secondary instrument does not answer	Check Secondary instruments

Tab. 2: Error codes and text messages, information on causes as well as corrective measures

### Function check

Code Text message	Cause	Rectification
C029 Simulation	Simulation active	Finish simulation Wait for the automatic end after 60 mins.

Tab. 3: Error codes and text messages, information on causes as well as corrective measures

### Out of specification

Code Text message	Cause	Rectification
S017 Accuracy outside the specification	Accuracy outside the specification	Correct adjustment data
S025 Bad linearization table	Bad linearization table	Carry out linearisation
S038 Secondary outside the specification	Secondary instrument outside the specification	Check Secondary instruments

Code Text message	Cause	Rectification
S125 Ambient temperature too high/too low	Ambient temperature too high/too low	Protect instrument with isolating material against extreme temperatures

Tab. 4: Error codes and text messages, information on causes as well as corrective measures

**Maintenance**

The instrument has no status messages to the section "Maintenance".

**9.3 Rectify faults**

**Reaction when malfunction occurs**

The operator of the system is responsible for taking suitable measures to rectify faults.

**Fault rectification**

The first measures are:

- Evaluation of fault messages
- Checking the output signal
- Treatment of measurement errors

A smartphone/tablet with the adjustment app or a PC/notebook with the software PACTware and the suitable DTM offer you further comprehensive diagnostic possibilities. In many cases, the causes can be determined in this way and the faults eliminated.

**Check output signal**

The following table describes possible faults that may not generate an error message:

Error	Cause	Rectification
The instrument signals covered without being covered by the measured medium  The instrument signals uncovered while covered with the measured medium	Voltage supply missing	Check cables for breaks; repair if necessary
	Operating voltage too low or load resistance too high	Check, adapt if necessary
	Electrical connection faulty	Check connection according to chapter "Connection steps" and if necessary, correct according to chapter "Wiring plan"
	Electronics defective	Change the switching behaviour of the sensors under "Diagnosis/Simulation". If the instrument does not switch over, send it in for repair.
Current signal greater than 22 mA or less than 3.6 mA	Buildup on the inner wall of the vessel	Remove buildup Check the Delta I value. Improve the switching threshold - carry out a double point adjustment
	Electronics module in the sensor defective	Note error messages on the display and adjustment module

**Reaction after fault rectification**

Depending on the reason for the fault and the measures taken, the steps described in chapter "Setup" must be carried out again or must be checked for plausibility and completeness.

**24 hour service hotline**

Should these measures not be successful, please call in urgent cases the VEGA service hotline under the phone no. **+49 1805 858550**.

The hotline is also available outside normal working hours, seven days a week around the clock.

Since we offer this service worldwide, the support is provided in English. The service itself is free of charge, the only costs involved are the normal call charges.

## 9.4 Exchanging the electronics module

If the electronics module is defective, it can be replaced by the user.



In Ex applications, only instruments and electronics modules with appropriate Ex approval may be used.

If there is no electronics module available on site, the electronics module can be ordered through the agency serving you. The electronics modules are adapted to the respective sensor and differ in signal output or voltage supply.

The new electronics module must be loaded with the default settings of the sensor. These are the options:

- In the factory
- Or on site by the user

In both cases, the serial number of the sensor is needed. The serial numbers are stated on the type label of the instrument, on the inside of the housing as well as on the delivery note.

When loading on site, the order data must first be downloaded from the Internet (see operating instructions " *Electronics module* ").



### Caution:

All application-specific settings must be entered again. That's why you have to carry out a fresh setup after exchanging the electronics.

If you saved the parameter settings during the first setup of the sensor, you can transfer them to the replacement electronics module. A fresh setup is then not necessary.

## 9.5 Software update

The following components are required to update the instrument software:

- Instrument
- Voltage supply
- Interface adapter VEGACONNECT
- PC with PACTware
- Current instrument software as file

You can find the current instrument software as well as detailed information on the procedure in the download area of our homepage: [www.vega.com](http://www.vega.com).

You can find information about the installation in the download file.



### Caution:

Instruments with approvals can be bound to certain software versions. Therefore make sure that the approval is still effective after a software update is carried out.



You can find detailed information in the download area at [www.vega.com](http://www.vega.com).

## 9.6 How to proceed if a repair is necessary

The following procedure refers only to the sensor. Should a repair of the source container be necessary, you can find the respective instructions in the operating instructions manual of the source container.

You can find an instrument return form as well as detailed information about the procedure in the download area of our homepage: [www.vega.com](http://www.vega.com)

By doing this you help us carry out the repair quickly and without having to call back for needed information.

If a repair is necessary, please proceed as follows:

- Print and fill out one form per instrument
- Clean the instrument and pack it damage-proof
- Attach the completed form and, if need be, also a safety data sheet outside on the packaging
- Please contact the agency serving you to get the address for the return shipment. You can find the agency on our home page [www.vega.com](http://www.vega.com).

## 10 Dismount

### 10.1 Dismounting steps

**Warning:**

Before dismantling, be aware of dangerous process conditions such as e.g. pressure in the vessel or pipeline, high temperatures, corrosive or toxic media etc.

Take note of chapters "*Mounting*" and "*Connecting to voltage supply*" and carry out the listed steps in reverse order.

### 10.2 Disposal

The instrument consists of materials which can be recycled by specialised recycling companies. We use recyclable materials and have designed the electronics to be easily separable.

**WEEE directive**

The instrument does not fall in the scope of the EU WEEE directive. Article 2 of this Directive exempts electrical and electronic equipment from this requirement if it is part of another instrument that does not fall in the scope of the Directive. These include stationary industrial plants.

Pass the instrument directly on to a specialised recycling company and do not use the municipal collecting points.

If you have no way to dispose of the old instrument properly, please contact us concerning return and disposal.

## 11 Supplement

### 11.1 Technical data

#### Note for approved instruments

The technical data in the respective safety instructions which are included in delivery are valid for approved instruments (e.g. with Ex approval). These data can differ from the data listed herein, for example regarding the process conditions or the voltage supply.

All approval documents can be downloaded from our homepage.

#### General data

316L corresponds to 1.4404 or 1.4435

Materials, non-wetted parts

- |   |   |
|---|---|
| - Detector tube                                 | 316L (only with version with 152 mm or 304 mm)                                  |
| - Scintillation material                        | PVT (Polyvinyltoluene)  |
| - Aluminium die-cast housing                    | Aluminium die-casting AlSi10Mg, powder-coated (Basis: Polyester)                |
| - Stainless steel housing                       | 316L  |
| - Seal between housing and housing lid          | NBR (stainless steel housing, investment casting), silicone (Aluminium housing) |
| - Inspection window in housing cover (optional) | Polycarbonate   |
| - Ground terminal                               | 316L  |
| - Cable gland                                   | PA, stainless steel, brass  |
| - Sealing, cable gland                          | NBR   |
| - Blind plug, cable gland                       | PA  |
| - Mounting accessories                          | 316L  |

Process fittings

- Fastening lugs ø 9 mm (0.35 in), hole centre distance 119 mm (4.69 in)

Weight

- |   |  |
|---|--|
| - Aluminium housing, with electronics       | 3.4 kg (7.5 lbs) + measuring length    |
| - Stainless steel housing, with electronics | 8.36 kg (18.43 lbs) + measuring length |
| - Measuring length 46 mm (1.8 in)           | 0.7 kg (1.54 lbs)                      |
| - Measuring length 152 mm (6 in)            | 0.98 kg (2.16 lbs)                     |
| - Measuring length 304 mm (12 in)           | 1.95 kg (4.3 lbs)                      |

Max. torque, mounting screws

- Fastening lugs in the sensor housing 15 Nm (11.1 lbf ft), stainless steel A4-70

Max. torque for NPT cable glands and Conduit tubes

- Aluminium/Stainless steel housing 50 Nm (36.88 lbf ft)

**Input variable**

Measured variable	The measured variable is the intensity of the gamma radiation. When the intensity of the radiation is below the stipulated value due to a damping by the medium, the POINTRAC 31 switches.
-------------------	--

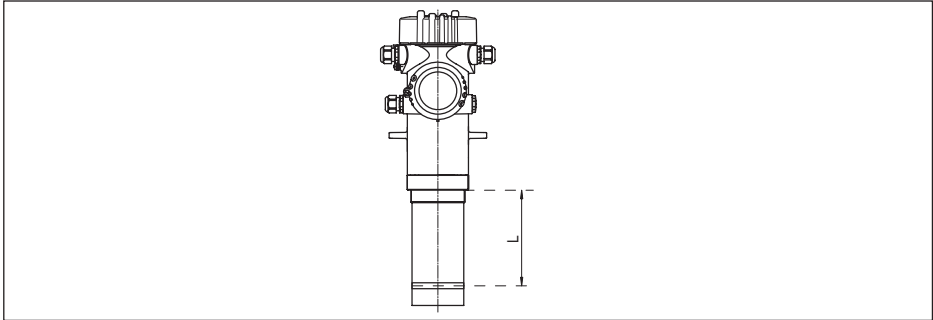

Fig. 22: Data of the input variable

L Measuring range (range in which the switching point must lie)

Measuring range	46 mm (1.8 in), 152 mm (6 in) or 304 mm (12 in)
Analogue input	
– Input type	4 ... 20 mA, passive
– Internal load	250 $\Omega$
Switching input	
– Type of input - Open Collector	10 mA
– Type of input - Relay contact	100 mA

**Output variable - Level detection**

Output signals	8/16 mA/HART - active; 8/16 mA/HART - Multidrop
Terminal voltage passive	9 ... 30 V DC
Shortcircuit protection	Available
Potential separation	Available
Fault signal, current output (adjustable)	22 mA, < 3.6 mA
Max. output current	22 mA
Starting current	$\leq$ 3.6 mA
Load	
– 8/16 mA/HART - active	< 500 $\Omega$
– 8/16 mA/HART - intrinsically safe	< 300 $\Omega$
Damping (63 % of the input variable)	Is calculated automatically by the instrument
HART output values	
– PV (Primary Value)	Switching status
– SV (Secondary Value)	Electronics temperature
– TV (Third Value)	Output value freely selectable, e.g. pulse rate

- QV (Quaternary Value)	Output value freely selectable, e.g. pulse rate
Fulfilled HART specification	7.0
Further information on Manufacturer ID, Device ID, Device Revision	See website of HART Communication Foundation

---

**Relay output**

---

Output	Relay output (SPDT), floating spdt
Switching voltage	max. 253 V AC/DC With circuits > 150 V AC/DC, the relay contacts must be in the same circuit.
Switching current	max. 3 A AC (cos phi > 0.9), 1 A DC
Breaking capacity	
- Min.	50 mW
- Max.	750 VA AC, 40 W DC (at U < 40 V DC) If inductive loads or stronger currents are switched through, the gold plating on the relay contact surface will be permanently damaged. The contact is then no longer suitable for switching low-level signal circuits.
Contact material (relay contacts)	AgNi or AgSnO2 each with 3 µm gold plating

---

**Transistor output**

---

Output	Floating transistor output, permanently shortcircuit-proof
Load current	< 400 mA
Voltage loss	< 1 V
Switching voltage	< 55 V DC
Blocking current	< 10 µA

---

**Measurement accuracy (according to DIN EN 60770-1)**

---

Process reference conditions according to DIN EN 61298-1	
- Temperature	+18 ... +30 °C (+64 ... +86 °F)
- Relative humidity	45 ... 75 %
- Air pressure	860 ... 1060 mbar/86 ... 106 kPa (12.5 ... 15.4 psig)
Non-repeatability	≤ 0.5 %
Deviation with bulk solids	The values depend to a great extent on the application. Binding specifications are thus not possible.
Deviation under EMC influence	≤ 1 %

---

**Variables influencing measurement accuracy**

---

**Specifications apply also to the current output**

Temperature drift - Current output	±0.03 %/10 K relating to the 16 mA span or max. ±0.3 %
Deviation in the current output due to analogue/digital conversion	<±15 µA

Deviation on the current output due to strong, high frequency electromagnetic interference acc. to EN 61326 <math>\leq \pm 150 \mu\text{A}</math>

### Ambient conditions

Storage and transport temperature -40 ... +60 °C (-40 ... +140 °F)

### Process conditions

For the process conditions, please also note the specifications on the type label. The lower value always applies.

Process pressure Unpressurized

Process temperature (measured on the detector tube) -40 ... +60 °C (-40 ... +140 °F)

With temperatures of more than 60 °C we recommend the use of water cooling

Vibration resistance<sup>4)</sup> mechanical vibrations up to 1 g in the frequency range 5 ... 200 Hz

### Electromechanical data - version IP66/IP67

Options of the cable entry

- Cable entry M20 x 1.5; ½ NPT
- Cable gland M20 x 1.5; ½ NPT (cable diameter see below table)
- Blind plug M20 x 1.5; ½ NPT
- Closing cap ½ NPT

Material cable gland	Material seal insert	Cable diameter				
		4.5 ... 8.5 mm	5 ... 9 mm	6 ... 12 mm	7 ... 12 mm	10 ... 14 mm
PA	NBR	-	●	●	-	●
Brass, nickel-plated	NBR	●	●	●	-	-
Stainless steel	NBR	-	●	●	-	●

Wire cross-section (spring-loaded terminals)

- Massive wire, stranded wire 0.2 ... 2.5 mm<sup>2</sup> (AWG 24 ... 14)
- Stranded wire with end sleeve 0.2 ... 1.5 mm<sup>2</sup> (AWG 24 ... 16)

### Integrated clock

Date format Day.Month.Year  
 Time format 12 h/24 h  
 Time zone, factory setting CET  
 Max. rate deviation 10.5 min/year

<sup>4)</sup> Tested according to the guidelines of German Lloyd, GL directive 2.

---

**Additional output parameter - Electronics temperature**

---

Output of the temperature values

- Analogue	Via the current output
- Digital	Via the digital output signal (depending on the electronics version)
Range	-40 ... +50 °C (-40 ... +122 °F)
Resolution	< 0.1 K
Accuracy	±5 K

---

**Voltage supply**

---

Operating voltage	20 ... 72 V DC or 20 ... 253 V AC, 50/60 Hz
Reverse voltage protection	Available
Max. power consumption	6 VA (AC); 4 W (DC)

---

**Electrical protective measures**

---

Protection, depending on housing version	IP66/IP67 (NEMA Type 4X) <sup>5)</sup>
Overvoltage category	The feeding power supply unit can be connected to networks of overvoltage category III.
Protection class	I

**11.2 Dimensions**

The following dimensional drawings represent only an extract of all possible versions. Detailed dimensional drawings can be downloaded at [www.vega.com/downloads](http://www.vega.com/downloads) under "Drawings".

<sup>5)</sup> A suitable cable is required for maintaining the protection rating.

Aluminium and stainless steel housing

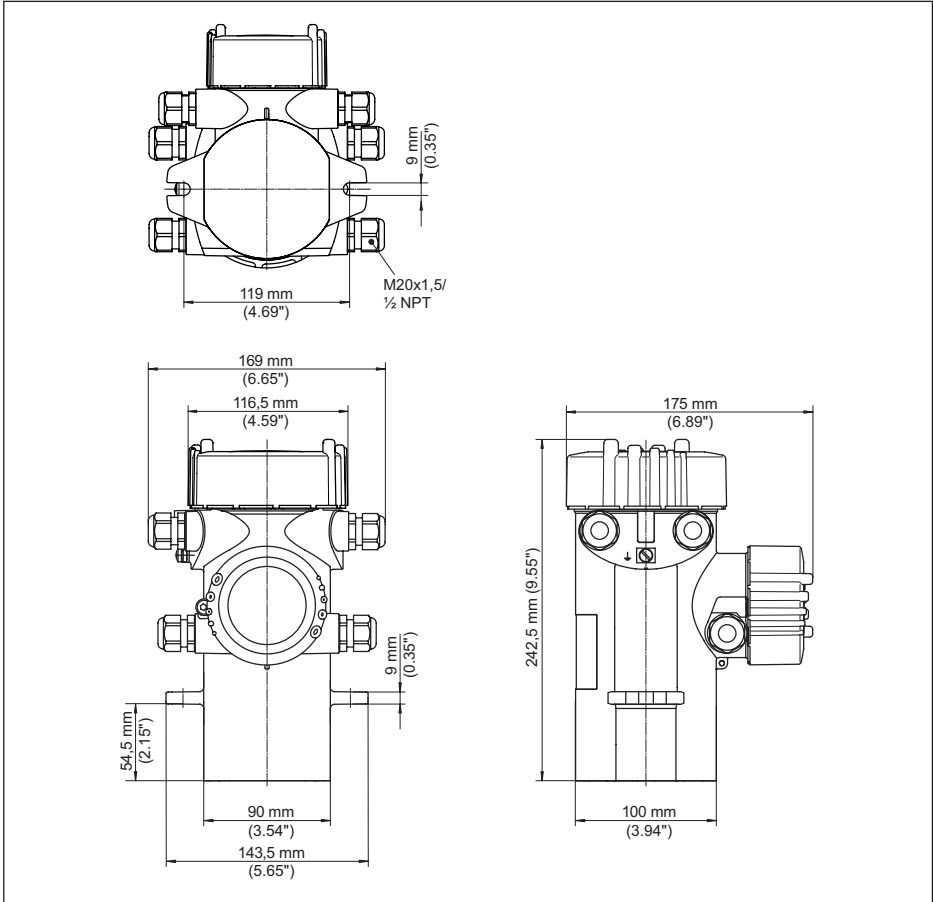

Fig. 23: Aluminium housing or stainless steel housing (precision casting)



**POINTRAC 31 with detector tube**

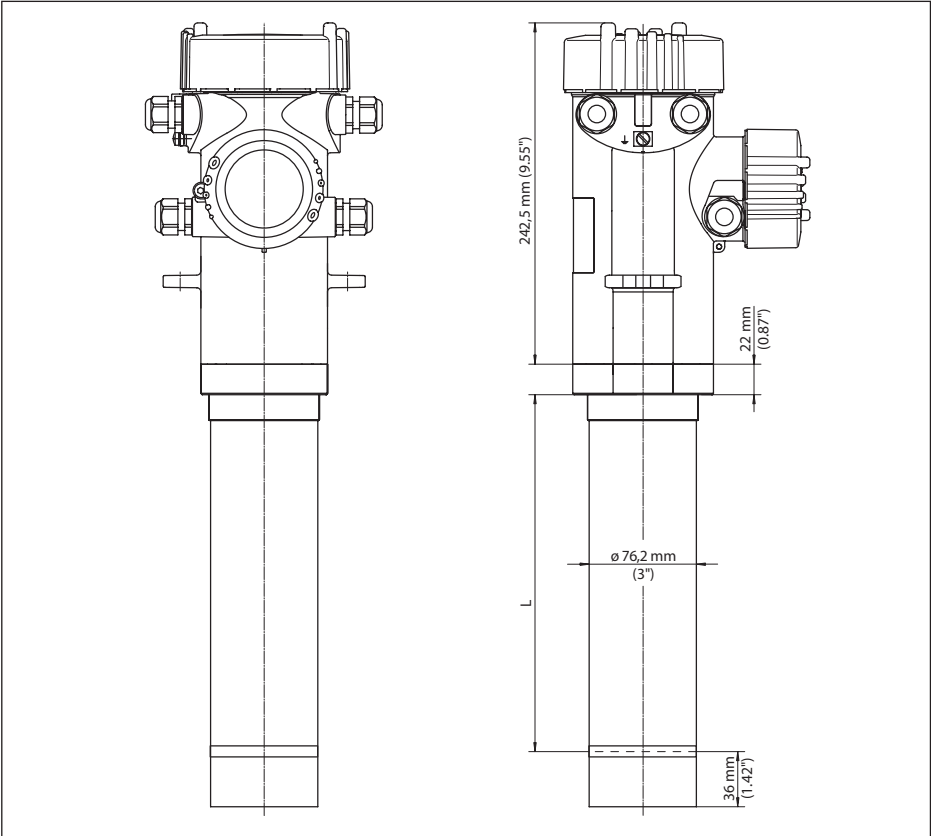

Fig. 24: POINTRAC 31 with detector tube - measuring length: 152 mm or 304 mm (6 in/12 in)

L Measuring range = Order length 152 mm or 304 mm (6 in/12 in)

**POINTRAC 31 - Mounting example**

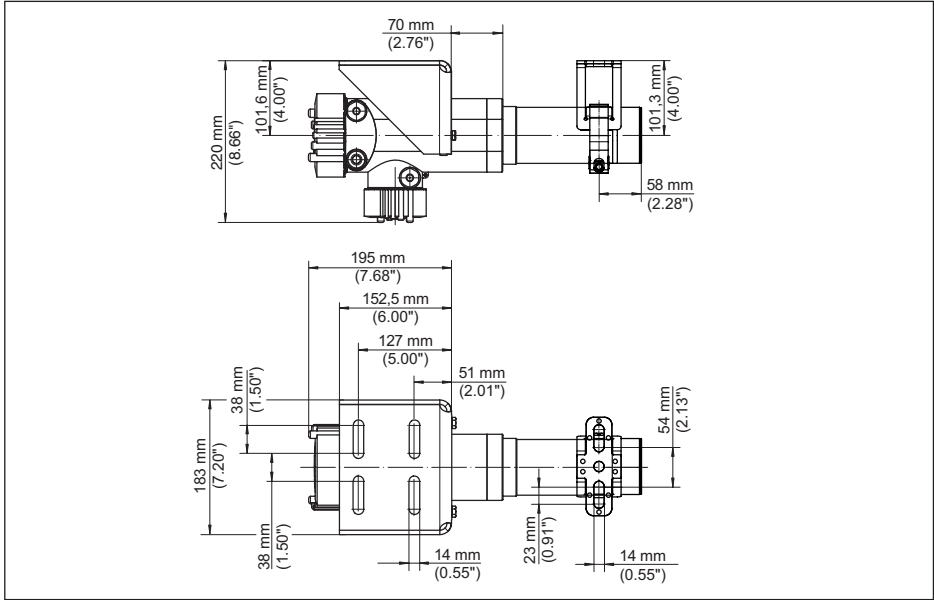

Fig. 25: POINTRAC 31 with detector tube, 152 mm or 304 mm (6 in/12 in) - with supplied mounting accessories

**POINTRAC 31 without detector tube**

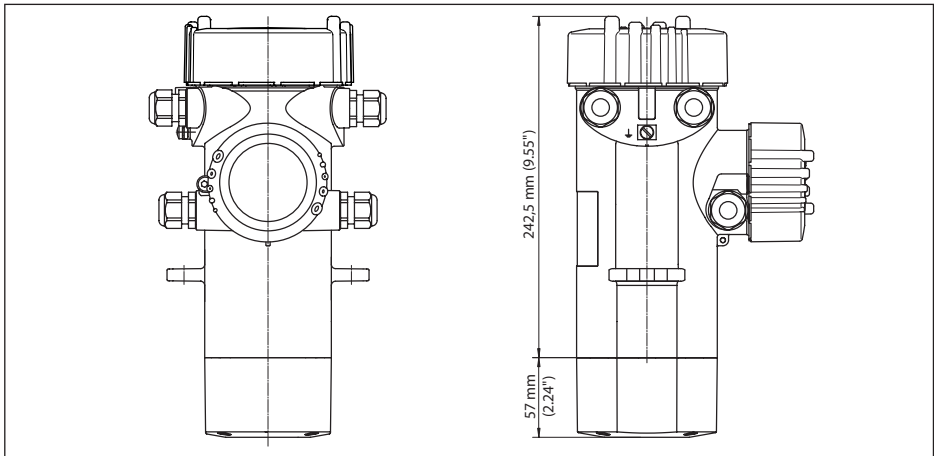

Fig. 26: POINTRAC 31 without detector tube - measuring range = order length 46 mm (1.8 in)

**POINTRAC 31 - Mounting example**

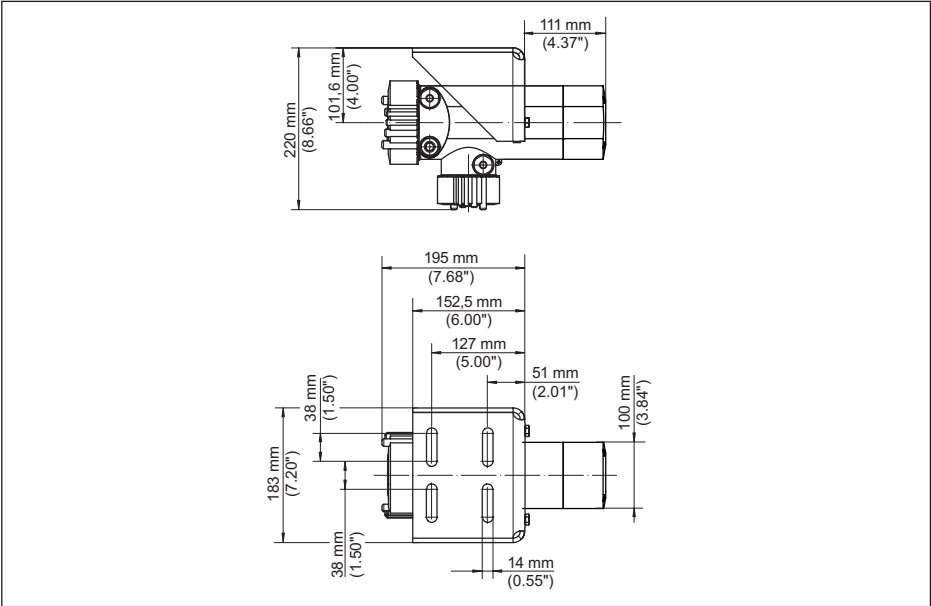

Fig. 27: POINTRAC 31 without detector tube, 46 mm (1.8 in) - supplied mounting accessories

### 11.3 Industrial property rights

VEGA product lines are global protected by industrial property rights. Further information see [www.vega.com](http://www.vega.com).

VEGA Produktfamilien sind weltweit geschützt durch gewerbliche Schutzrechte.

Nähere Informationen unter [www.vega.com](http://www.vega.com).

Les lignes de produits VEGA sont globalement protégées par des droits de propriété intellectuelle. Pour plus d'informations, on pourra se référer au site [www.vega.com](http://www.vega.com).

VEGA lineas de productos están protegidas por los derechos en el campo de la propiedad industrial. Para mayor información revise la pagina web [www.vega.com](http://www.vega.com).

Линии продукции фирмы ВЕГА защищаются по всему миру правами на интеллектуальную собственность. Дальнейшую информацию смотрите на сайте [www.vega.com](http://www.vega.com).

VEGA系列产品在全球享有知识产权保护。

进一步信息请参见网站 < [www.vega.com](http://www.vega.com)。

### 11.4 Trademark

All the brands as well as trade and company names used are property of their lawful proprietor/originator.

## INDEX

### A

- Accessories 10
  - Display and adjustment module 9
  - External display and adjustment unit 9
  - External indicating unit 9
  - Gamma modulator 10
- Adjustment
  - System 27
- Adjustment data 35
- Adjustment mode 30
- Adjustment point 31
- Application 30

### B

- Background radiation 30

### C

- Cable entry 14, 20
- Cable gland 14, 20
- Check signal 47
- Connection cable 20
- Connection procedure 21
- Connection technology 21
- Control areas 12
- Cooling 10
- Current output mode 33

### D

- Damping 36
- Date 36
- Date of manufacture 38
- Default values 37
- Delta I 31
- Device DTM 41
- Device name 38
- Device settings Copy 38
- Displayed value 34

### E

- EDD (Enhanced Device Description) 43

### F

- Fault
  - Rectification 47
- Fault rectification 47
- Functional principle 8

### G

- Gamma modulator 10
- Grounding 21

### H

- Handling permit 11
- HART 37
- Heat 19

### I

- Installation position 14
- Instrument features 38
- Instrument return form 49
- Instrument version 38
- Isotope
  - Co-60 29
  - Cs-137 29

### L

- Language 34
- Lock adjustment 34

### M

- Main menu 28
- Measurement loop name 29
- Mode 37

### N

- NAMUR NE 107 44
  - Failure 45
  - Function check 46
  - Maintenance 47
  - Out of specification 46

### P

- PACTware 41
- Peak value indicator 35
- Potential equalisation 21
- Protection class 20

### R

- Radiation protection 12
- Radiation safety officer 12
- Relay 33
- Repair 49
- Replacement parts
  - Electronics module 9
- Reset 36

### S

- Sensor orientation 17
- Sensor status 35
- Service hotline 47
- Shielding 21

Simulation 35  
Source 29  
Source holder 11

**T**

Time 36  
Type label 7

**U**

Unit 30

**V**

Voltage supply 20, 55

**W**

Water cooling 19

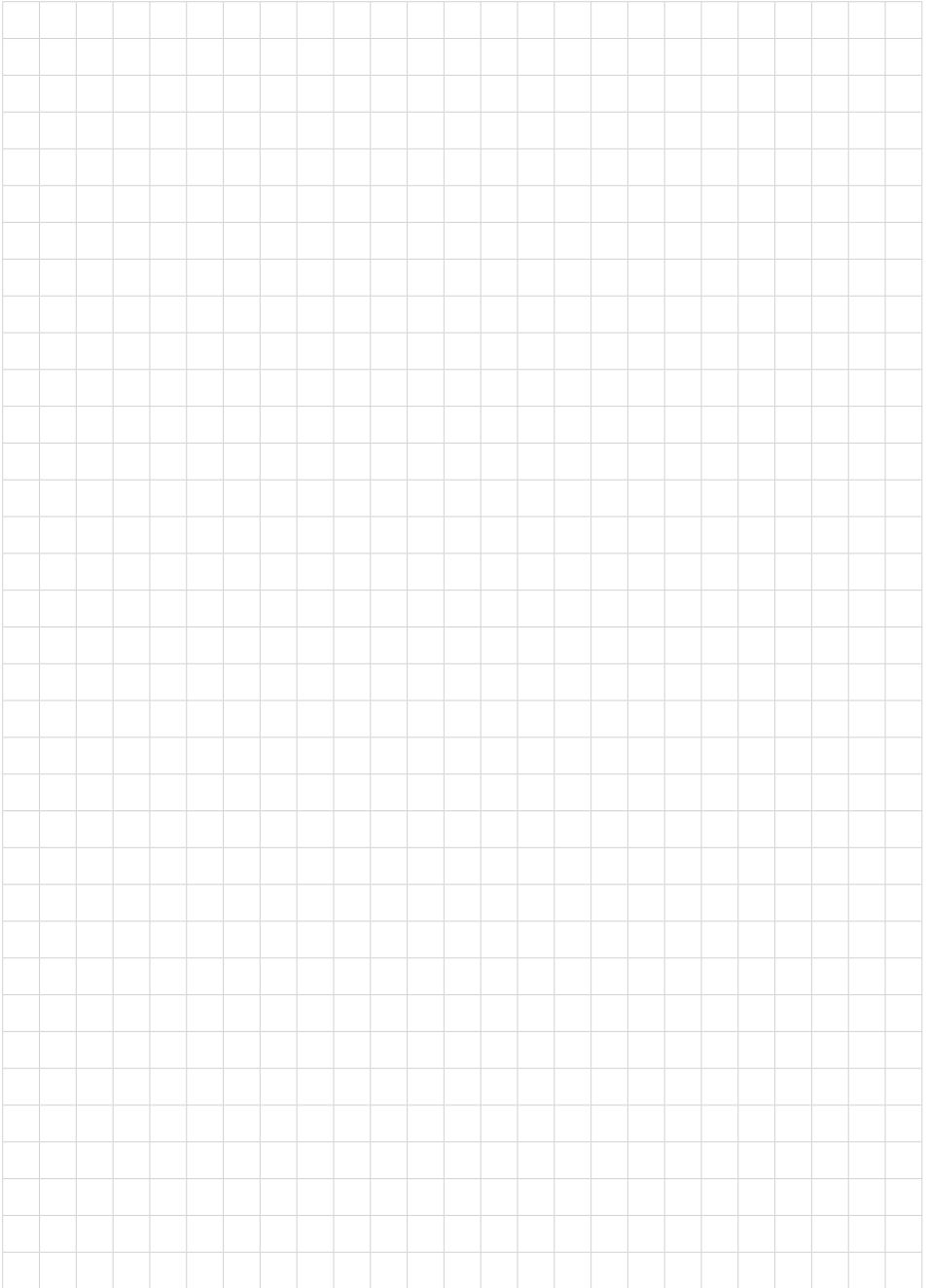

39411-EN-210311

Printing date:

# VEGA

All statements concerning scope of delivery, application, practical use and operating conditions of the sensors and processing systems correspond to the information available at the time of printing.

Subject to change without prior notice

© VEGA Grieshaber KG, Schiltach/Germany 2021



39411-EN-210311

VEGA Grieshaber KG  
Am Hohenstein 113  
77761 Schiltach  
Germany

Phone +49 7836 50-0  
E-mail: [info.de@vega.com](mailto:info.de@vega.com)  
[www.vega.com](http://www.vega.com)