

Operating Instructions

Radiometric sensor for continuous level
and interface measurement

FIBERTRAC 32

Four-wire 4 ... 20 mA/HART



Document ID: 37428



VEGA

Contents

1	About this document	4
1.1	Function	4
1.2	Target group	4
1.3	Symbols used.....	4
2	For your safety	5
2.1	Authorised personnel	5
2.2	Appropriate use.....	5
2.3	Warning about incorrect use.....	5
2.4	General safety instructions	5
2.5	EU conformity.....	6
2.6	NAMUR recommendations	6
2.7	Installation and operation in the USA and Canada	6
2.8	Environmental instructions	6
3	Product description	7
3.1	Configuration.....	7
3.2	Principle of operation.....	8
3.3	Packaging, transport and storage.....	8
3.4	Accessories.....	9
3.5	Corresponding source container	11
4	Mounting	13
4.1	General instructions	13
4.2	Mounting instructions	14
5	Connecting to power supply	18
5.1	Preparing the connection	18
5.2	Connection - Level measurement.....	21
5.3	Connection - Level detection.....	23
5.4	Connection - Summation.....	25
6	Set up with the display and adjustment module	27
6.1	Insert display and adjustment module	27
6.2	Adjustment system	28
6.3	Parameter adjustment - Level measurement	29
6.4	Parameter adjustment - Summation Secondary.....	42
6.5	Parameter adjustment - Point level detection.....	46
6.6	Saving the parameterisation data.....	56
7	Setup with smartphone/tablet (Bluetooth)	57
7.1	Preparations.....	57
7.2	Connecting.....	57
7.3	Sensor parameter adjustment	58
8	Setup with PACTware	59
8.1	Connect the PC.....	59
8.2	Parameter adjustment with PACTware.....	60
8.3	Saving the parameterisation data.....	61
9	Setup with PC/notebook (Bluetooth)	62
9.1	Preparations.....	62
9.2	Connecting.....	62

9.3	Parameter adjustment	63
10	Set up with other systems	64
10.1	DD adjustment programs	64
10.2	Field Communicator 375, 475	64
11	Diagnostics and servicing	65
11.1	Maintenance	65
11.2	Status messages.....	65
11.3	Rectify faults.....	68
11.4	Exchanging the electronics module.....	70
11.5	Software update	70
11.6	How to proceed if a repair is necessary.....	71
12	Dismount.....	72
12.1	Dismounting steps.....	72
12.2	Disposal	72
13	Supplement	73
13.1	Technical data	73
13.2	Dimensions	78
13.3	Industrial property rights.....	82
13.4	Trademark	82



Safety instructions for Ex areas

Take note of the Ex specific safety instructions for Ex applications. These instructions are attached as documents to each instrument with Ex approval and are part of the operating instructions.

Editing status: 2021-03-04

1 About this document

1.1 Function

This instruction provides all the information you need for mounting, connection and setup as well as important instructions for maintenance, fault rectification, the exchange of parts and the safety of the user. Please read this information before putting the instrument into operation and keep this manual accessible in the immediate vicinity of the device.

1.2 Target group

This operating instructions manual is directed to trained personnel. The contents of this manual must be made available to the qualified personnel and implemented.

1.3 Symbols used



Document ID

This symbol on the front page of this instruction refers to the Document ID. By entering the Document ID on www.vega.com you will reach the document download.



Information, note, tip: This symbol indicates helpful additional information and tips for successful work.



Note: This symbol indicates notes to prevent failures, malfunctions, damage to devices or plants.



Caution: Non-observance of the information marked with this symbol may result in personal injury.



Warning: Non-observance of the information marked with this symbol may result in serious or fatal personal injury.



Danger: Non-observance of the information marked with this symbol results in serious or fatal personal injury.



Ex applications

This symbol indicates special instructions for Ex applications.



List

The dot set in front indicates a list with no implied sequence.



Sequence of actions

Numbers set in front indicate successive steps in a procedure.



Battery disposal

This symbol indicates special information about the disposal of batteries and accumulators.

2 For your safety

2.1 Authorised personnel

All operations described in this documentation must be carried out only by trained, qualified personnel authorised by the plant operator.

During work on and with the device, the required personal protective equipment must always be worn.

2.2 Appropriate use

FIBERTRAC 32 is a sensor for continuous level measurement.

You can find detailed information about the area of application in chapter " *Product description*".

Operational reliability is ensured only if the instrument is properly used according to the specifications in the operating instructions manual as well as possible supplementary instructions.

2.3 Warning about incorrect use

Inappropriate or incorrect use of this product can give rise to application-specific hazards, e.g. vessel overflow through incorrect mounting or adjustment. Damage to property and persons or environmental contamination can result. Also, the protective characteristics of the instrument can be impaired.

2.4 General safety instructions

This is a state-of-the-art instrument complying with all prevailing regulations and directives. The instrument must only be operated in a technically flawless and reliable condition. The operator is responsible for the trouble-free operation of the instrument. When measuring aggressive or corrosive media that can cause a dangerous situation if the instrument malfunctions, the operator has to implement suitable measures to make sure the instrument is functioning properly.

The safety instructions in this operating instructions manual, the national installation standards as well as the valid safety regulations and accident prevention rules must be observed by the user.

For safety and warranty reasons, any invasive work on the device beyond that described in the operating instructions manual may be carried out only by personnel authorised by the manufacturer. Arbitrary conversions or modifications are explicitly forbidden. For safety reasons, only the accessory specified by the manufacturer must be used.

To avoid any danger, the safety approval markings and safety tips on the device must also be observed.

This measuring system uses gamma rays. Therefore take note of the instructions for radiation protection in chapter "*Product description*". Any work on the source container may only be carried out under the supervision of a qualified radiation protection officer.

2.5 EU conformity

The device fulfils the legal requirements of the applicable EU directives. By affixing the CE marking, we confirm the conformity of the instrument with these directives.

The EU conformity declaration can be found on our homepage.

Electromagnetic compatibility

Instruments in four-wire or Ex-d-ia version are designed for use in an industrial environment. Nevertheless, electromagnetic interference from electrical conductors and radiated emissions must be taken into account, as is usual with class A instruments according to EN 61326-1. If the instrument is used in a different environment, the electromagnetic compatibility to other instruments must be ensured by suitable measures.

2.6 NAMUR recommendations

NAMUR is the automation technology user association in the process industry in Germany. The published NAMUR recommendations are accepted as the standard in field instrumentation.

The device fulfils the requirements of the following NAMUR recommendations:

- NE 21 – Electromagnetic compatibility of equipment
- NE 43 – Signal level for fault information from measuring transducers
- NE 53 – Compatibility of field devices and display/adjustment components
- NE 107 – Self-monitoring and diagnosis of field devices

For further information see www.namur.de.

2.7 Installation and operation in the USA and Canada

This information is only valid for USA and Canada. Hence the following text is only available in the English language.

Installations in the US shall comply with the relevant requirements of the National Electrical Code (ANSI/NFPA 70).

Installations in Canada shall comply with the relevant requirements of the Canadian Electrical Code.

2.8 Environmental instructions

Protection of the environment is one of our most important duties. That is why we have introduced an environment management system with the goal of continuously improving company environmental protection. The environment management system is certified according to DIN EN ISO 14001.

Please help us fulfil this obligation by observing the environmental instructions in this manual:

- Chapter " *Packaging, transport and storage* "
- Chapter " *Disposal* "

3 Product description

3.1 Configuration

Type label

The type label contains the most important data for identification and use of the instrument:

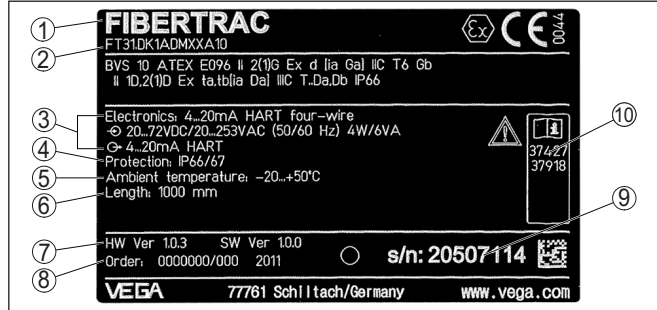

Fig. 1: Layout of the type label (example)

- 1 Instrument type
- 2 Product code
- 3 Electronics
- 4 Protection rating
- 5 Ambient temperature
- 6 Measuring range
- 7 Hardware and software version
- 8 Order number
- 9 Serial number of the instrument
- 10 ID numbers, instrument documentation

Serial number - Instrument search

The type label contains the serial number of the instrument. With it you can find the following instrument data on our homepage:

- Product code (HTML)
- Delivery date (HTML)
- Order-specific instrument features (HTML)
- Operating instructions and quick setup guide at the time of shipment (PDF)
- Order-specific sensor data for an electronics exchange (XML)
- Test certificate (PDF) - optional

Move to "www.vega.com" and enter in the search field the serial number of your instrument.

Alternatively, you can access the data via your smartphone:

- Download the VEGA Tools app from the "[Apple App Store](#)" or the "[Google Play Store](#)"
- Scan the DataMatrix code on the type label of the instrument or
- Enter the serial number manually in the app

Scope of this operating instructions

This operating instructions manual applies to the following instrument versions:

- Hardware from 1.0.6 ¹⁾
- Software from 2.1.0
- Hardware from 2.0.0
- Software from 3.0.0

Electronics versions

The instrument is available in different electronics versions. Each version can be identified via the product code on the type label:

- Standard electronics type PROTRACH.-XX

Scope of delivery

The scope of delivery encompasses:

- Radiometric sensor
- Mounting accessories
- Documentation
- Bluetooth module (optional)
 - This operating instructions manual
 - Ex-specific "*Safety instructions*" (with Ex versions)
 - If necessary, further certificates

3.2 Principle of operation**Application area**

The instrument is suitable for applications in liquids and bulk solids in vessels under difficult process conditions. There are application possibilities in nearly all areas of industry.

The level is detected contactlessly right through the vessel wall.

Neither a process fitting nor a vessel opening are required. The instrument is thus ideal for retro installation.

Functional principle

In radiometric measurement, a Caesium-137 or Cobalt-60 isotope emits focussed gamma rays that are attenuated when penetrating the vessel wall and the medium. The PVT detector on the opposite side of the tank receives the radiation, whose strength is dependent on the level. The measuring principle has proven to be very reliable in conjunction with extreme process conditions because it measures contactlessly from outside through the vessel wall. The measuring system ensures maximum safety, reliability and plant availability, independently of the medium and its properties.

3.3 Packaging, transport and storage**Packaging**

Your instrument was protected by packaging during transport. Its capacity to handle normal loads during transport is assured by a test based on ISO 4180.

The packaging consists of environment-friendly, recyclable cardboard. For special versions, PE foam or PE foil is also used. Dispose of the packaging material via specialised recycling companies.

Transport

Transport must be carried out in due consideration of the notes on the transport packaging. Nonobservance of these instructions can cause damage to the device.

¹⁾ It is not possible to update the software to 3.0.0. In this case the electronics module must be exchanged.

Transport inspection	The delivery must be checked for completeness and possible transit damage immediately at receipt. Ascertained transit damage or concealed defects must be appropriately dealt with.
Storage	<p>Up to the time of installation, the packages must be left closed and stored according to the orientation and storage markings on the outside.</p> <p>Unless otherwise indicated, the packages must be stored only under the following conditions:</p> <ul style="list-style-type: none"> ● Not in the open ● Dry and dust free ● Not exposed to corrosive media ● Protected against solar radiation ● Avoiding mechanical shock and vibration
Storage and transport temperature	<ul style="list-style-type: none"> ● Storage and transport temperature see chapter " <i>Supplement - Technical data - Ambient conditions</i>" ● Relative humidity 20 ... 85 %
Lifting and carrying	With instrument weights of more than 18 kg (39.68 lbs) suitable and approved equipment must be used for lifting and carrying.

3.4 Accessories

PLICSCOM	<p>The display and adjustment module is used for measured value indication, adjustment and diagnosis.</p> <p>The integrated Bluetooth module (optional) enables wireless adjustment via standard adjustment devices.</p>
VEGACONNECT	The interface adapter VEGACONNECT enables the connection of communication-capable instruments to the USB interface of a PC.
VEGADIS 81	The VEGADIS 81 is an external display and adjustment unit for VEGA plics® sensors.
VEGADIS 82	VEGADIS 82 is suitable for measured value indication and adjustment of sensors with HART protocol. It is looped into the 4 ... 20 mA/HART signal cable.
External indicating unit	The VEGADIS 62 is suitable for measured value indication of sensors. It is looped into the 4 ... 20 mA/HART signal cable.
Electronics module - PT30	<p>The electronics module PT30... is a replacement part for radiometric sensors FIBERTRAC 32.</p> <p>It is located in the large electronics and connection compartment.</p> <p>The electronics module can only be exchanged by VEGA service technician.</p>
Supplementary electronics module - PROTRAC.ZE	<p>The supplementary electronics module PROTRAC.ZE... is a replacement part for radiometric sensors FIBERTRAC 32.</p> <p>It is located in the lateral adjustment and connection compartment.</p>

Device cooling

The radiometric sensor has temperature limits which must not be exceeded. In case the max. permissible temperature is exceeded, faulty measurements and a permanent damage of the sensor can be caused.

You have several possibilities to avoid too high ambient temperatures:

Passive sun shade

Direct sun increases the temperature on the sensor by 20 °K. The best possibility to protect the sensor against the effects of direct sun is a suitable roof structure.

If this is not possible or only with great effort, then you can use the passive sun shade. The passive sun shade consists of a housing sun shade and a sun protection hose and can reduce the sensor temperature by 10 °K.

Air cooling

For ambient temperatures up to +80 °C you can use an air cooling. The cooling air is generated with vortex coolers. Please check if sufficient compressed air is available. You can find further information in the supplementary instructions of the air cooling. The air cooling cannot be retrofitted.

Water cooling

For ambient temperatures up to +100 °C you can use a water cooling. Please check if sufficient cooled water is available. You can find further information in the supplementary instructions of the water cooling. The water cooling cannot be retrofitted.

Gamma modulator

In order to exclude external interference radiation, you can mount a gamma modulator in front of the source holder. This allows reliable measurement even when interference radiation occurs.

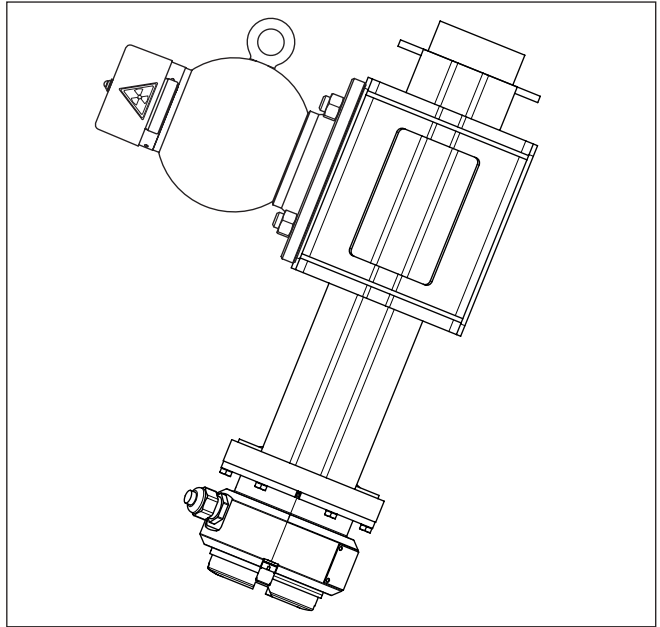

Fig. 2: Gamma modulator (optional) for uninterrupted measurement even with interference radiation

1 Gamma modulator (mounted on the source holder)

For ambient temperatures up to 120 °C (248 °C) the gamma modulator is optionally available with water cooling.

Any number of devices can be synchronized. To synchronize several gamma modulators, you need a controller.

Shielding

The shielding for PROTRAC detectors is a mechanical protection shield to reduce the influence of external radiation on the sensor. This is the case, for example, with external radiation sources, background radiation or other radiometric measuring systems.

3.5 Corresponding source container

A radioactive isotope in a suitable source holder is the prerequisite for a radiometric measurement setup.

The handling of radioactive substances is regulated by law. The radiation protection rules of the country in which the system is operated apply first and foremost.

In Germany, for example, the current radiation protection ordinance (StrlSchV) based on the Atomic Energy Law (AtG) applies.

The following points are important for measurement with radiometric methods:

Handling permit

A handling permit is required for operation of a system using gamma rays. This permit is issued by the respective government office or the responsible authority (in Germany, for example, offices for environmental protection, trade supervisory boards, etc.)

You can find further instructions in the operating instructions manual of the source container.

General instructions for radiation protection

When handling radioactive sources, unnecessary radiation exposure must be avoided. An unavoidable radiation exposure must be kept as low as possible. Take note of the following three important measures:

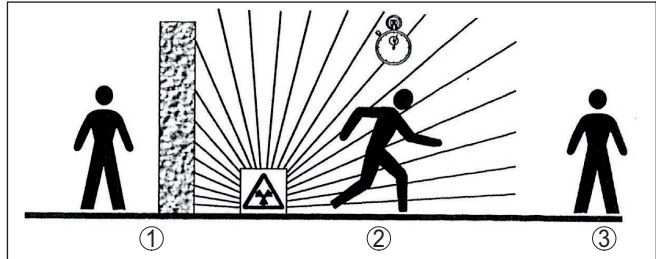

Fig. 3: Measures for protection against radioactive radiation

- 1 Shielding
- 2 Time
- 3 Distance

Shielding: Provide good shielding between the source and yourself as well as all other persons. Special source containers (e.g. VEGASOURCE) as well as all materials with high density (e.g. lead, iron, concrete, etc.) provide effective shielding.

Time: Stay as short a time as possible in radiation exposed areas.

Distance: Your distance to the source should be as large as possible. The local dose rate of the radiation decreases in proportion to the square of the distance to the radiation source.

Radiation safety officer

The plant operator must appoint a radiation safety officer with the necessary expert knowledge. He is responsible for ensuring that the radiation protection ordinance is complied with and for implementing all radiation protection measures.

Control area

Control areas are areas in which the local dose rate exceeds a certain value. Only persons who undergo official dose monitoring are allowed into these control areas. You can find the respectively valid limit values for control areas in the guideline of the respective authority (in Germany, for example, the radiation protection ordinance).

We are at your disposal for further information concerning radiation protection and regulations in other countries.

4 Mounting

4.1 General instructions

Switch off source

The source container is part of the measuring system. In case the source container is already equipped with an active isotope, the source container must be locked before mounting.



Danger:

Before mounting; make sure that the source is securely closed. Use a padlock to secure the source container in the closed condition and prevent it from being inadvertently opened.

Protection against moisture

Protect your instrument against moisture ingress through the following measures:

- Use a suitable connection cable (see chapter " *Connecting to power supply* ")
- Tighten the cable gland or plug connector
- Lead the connection cable downward in front of the cable entry or plug connector

This applies mainly to outdoor installations, in areas where high humidity is expected (e.g. through cleaning processes) and on cooled or heated vessels.



Note:

Make sure that during installation or maintenance no moisture or dirt can get inside the instrument.

To maintain the housing protection, make sure that the housing lid is closed during operation and locked, if necessary.

Process conditions



Note:

For safety reasons, the instrument must only be operated within the permissible process conditions. You can find detailed information on the process conditions in chapter " *Technical data* " of the operating instructions or on the type label.

Hence make sure before mounting that all parts of the instrument exposed to the process are suitable for the existing process conditions.

These are mainly:

- Active measuring component
- Process fitting
- Process seal

Process conditions in particular are:

- Process pressure
- Process temperature
- Chemical properties of the medium
- Abrasion and mechanical influences

Cable glands**Metric threads**

In the case of instrument housings with metric thread, the cable glands are screwed in at the factory. They are sealed with plastic plugs as transport protection.

You have to remove these plugs before electrical connection.

NPT thread

In the case of instrument housings with self-sealing NPT threads, it is not possible to have the cable entries screwed in at the factory. The free openings for the cable glands are therefore covered with red dust protection caps as transport protection.

Prior to setup you have to replace these protective caps with approved cable glands or close the openings with suitable blind plugs.

The suitable cable glands and blind plugs come with the instrument.

4.2 Mounting instructions**Installation position****Note:**

During the planning, our specialists will analyse the conditions of the measurement loop to dimension the isotope accordingly.

You get a "Source Sizing" document specifying the required source activity and containing all relevant mounting information for your measuring point.

You must follow the instructions in this "Source Sizing" document in addition to the following mounting instructions.

The following mounting information is applicable as long as there is nothing else specified in the "Source Sizing" document.

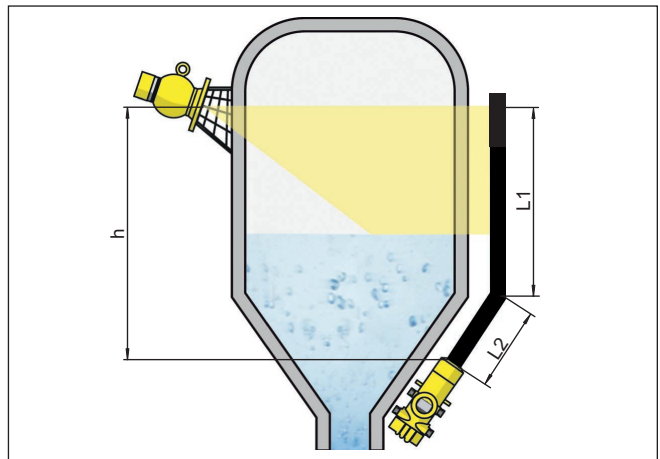

Fig. 4: Level measurement in a storage tank

h Measuring range

L Measurement length (*L*1, *L*2)

You can find information on protective barriers and the mounting of the corresponding source container in the operating instructions manual of the source container, e.g. VEGASOURCE.

You can mount the FIBERTRAC 32 with the housing head upward or downward. When the housing head is mounted downward, the housing itself is more easily accessible.

Fasten the sensor in such a way that it cannot fall out of the holder. If necessary, provide the sensor with a support from below.

Direct the exit angle of the source container to the FIBERTRAC 32.

Mount the source container as close as possible to the vessel. If there are gaps, secure the area with a safety fence and protective grating so that no one can reach into the dangerous area.

Mounting clamps

You can mount the sensor on your vessel with the enclosed mounting clamps. A number of mounting clamps come with the FIBERTRAC 32 depending on the length of the sensor.

Use a mounting clamp approx. every 450 mm (17.72 in). During mounting, adjust the distances between the attached mounting clips.

Take note of the minimum bending radius of the sensor, which is 305 mm (12 in).

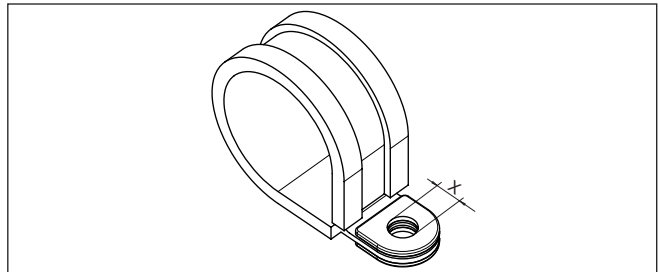

Fig. 5: Mounting clamp

x Hole for screw M8

→ Determine the exact mounting position of one or several mounting clamps and mark the holes.

Align the mounting positions exactly and average the distances between the enclosed mounting clamps.

Drill appropriate holes (max. M12) for fastening the mounting clamps.



Note:

The mounting clamps do not come with fastening screws. Use fastening elements that are appropriate for the situation in your plant.

Summation

To measure the level in very high vessels, multiple instruments can be cascaded.

Cascading means that two or several instruments are connected which can together cover a longer measuring range.

You can find the exact number of Secondaries in the " Safety Manual".

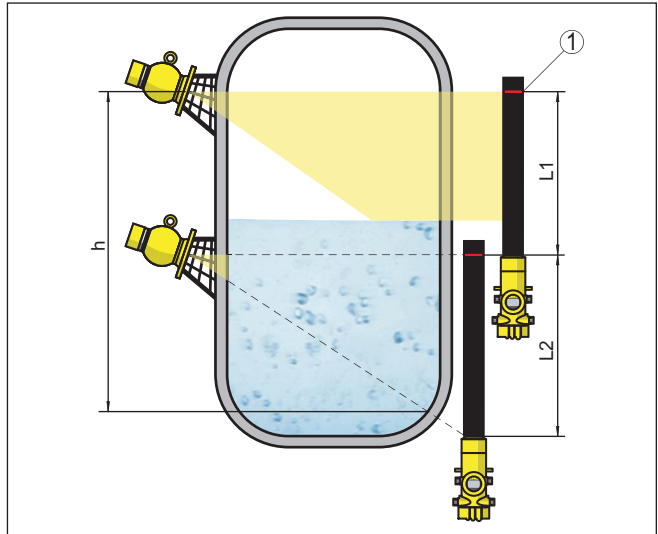

Fig. 6: Installation position - cascading arrangement

h Summed measuring range

L Measurement length (*L1*, *L2*)

1 Red marking line for designating the measuring range

Here, one instrument acts as a Primary and all other instruments operate as Summation Secondary. The pulse rates of all instruments are summed in the Primary instrument and converted into a common signal.

If several sensors are cascaded, the measuring ranges of the individual detectors must directly join each other. The detectors must also slightly overlap.

Make sure that the red marking lines directly join the measuring range of the next FIBERTRAC 32.

Mount the FIBERTRAC 32 in such a way that the detector hose is directly in the radiated area of the source container. Mount the FIBERTRAC 32 preferably side by side and make sure that no detector hose is hidden by another sensor.

Vessel with heat insulation

On vessels with temperature insulation, the sensor and the source container should be preferably mounted outside of the tank insulation.

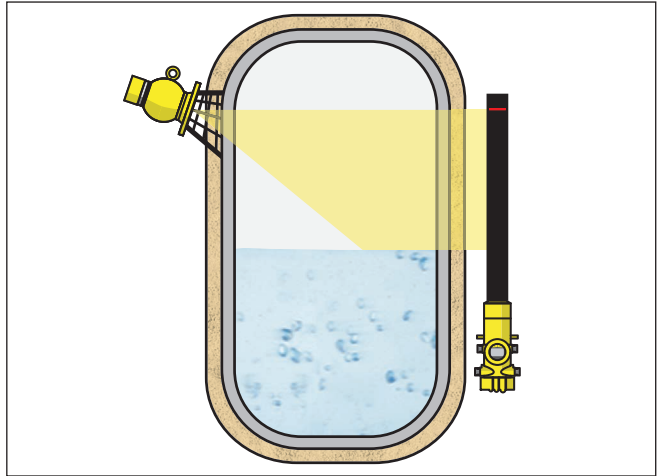

Fig. 7: Level measurement on a heated vessel with heat insulation

If this is not possible, make sure that there is a sufficiently large cut-out in the tank insulation for mounting the sensor and the source container. Make sure that the max. ambient temperature of the sensor is not exceeded.

Protection against heat

If the max. ambient temperature is exceeded, you must take suitable measures to protect the instrument against overheating.

You can protect the instrument by providing a suitable insulation against the heat or mounting the instrument further away from the heat source.

Make sure these measures are taken into account already in the planning stage. If you want to carry out such measures later on, contact our specialists to ensure that the accuracy of the application is not impaired.

If these measures are not sufficient to maintain the max. ambient temperature, you could consider using the water or air cooling system we offer for FIBERTRAC 32.

The cooling system must also be included in the calculations for the measuring point. Contact our specialists regarding the dimensioning of the cooling.

5 Connecting to power supply

5.1 Preparing the connection

Safety instructions

Always keep in mind the following safety instructions:

- The electrical connection must only be carried out by trained, qualified personnel authorised by the plant operator.
- If overvoltage surges are expected, overvoltage arresters should be installed.



Warning:

Only connect or disconnect in de-energized state.

Voltage supply via mains voltage

In this case, the instrument is designed in protection class I. To maintain this protection class, it is absolutely necessary that the ground conductor be connected to the internal ground terminal. Take note of the national installation regulations.

Supply voltage and current output are carried on separate connection cables if reliable separation is required. The supply voltage range can differ depending on the instrument version.

The data for power supply are specified in chapter " *Technical data*".

Select connection cable

General requirements

- Make sure that the cable used has the required temperature resistance and fire safety for max. occurring ambient temperature
- Use cable with round cross section for instruments with housing and cable gland. To ensure the seal effect of the cable gland (IP protection rating), find out which cable outer diameter the cable gland is suitable for.
- Use a cable gland fitting the cable diameter.
- Unused cable glands do not offer sufficient protection against moisture and must be replaced by blind plugs.

Voltage supply

For power supply, an approved, three-wire installation cable with PE conductor is required.

Signal cable

The 4 ... 20 mA current output is connected with standard two-wire cable without shielding. If electromagnetic interference is expected which is above the test values of EN 61326-1 for industrial areas, shielded cable should be used.

Cable glands

Metric threads

In the case of instrument housings with metric thread, the cable glands are screwed in at the factory. They are sealed with plastic plugs as transport protection.

You have to remove these plugs before electrical connection.

NPT thread

In the case of instrument housings with self-sealing NPT threads, it is not possible to have the cable entries screwed in at the factory. The

free openings for the cable glands are therefore covered with red dust protection caps as transport protection.

Before setup you have to replace these protective caps with approved cable glands or close the openings with suitable blind plugs. Unused cable glands do not provide sufficient protection against moisture and must be replaced with blind plugs.

The suitable cable glands and blind plugs come with the instrument.

Cable screening and grounding

If shielded cable is required, connect the cable screen on both ends to ground potential. In the sensor, the screen must be connected directly to the internal ground terminal. The ground terminal on the outside of the housing must be connected to the potential equalisation (low impedance).

If potential equalisation currents are expected, the connection on the processing side must be made via a ceramic capacitor (e. g. 1 nF, 1500 V). The low-frequency potential equalisation currents are thus suppressed, but the protective effect against high frequency interference signals remains.



Warning:

Significant potential differences exist inside galvanization plants as well as on vessels with cathodic corrosion protection. Considerable equalisation currents can flow over the cable screen if the screen is grounded on both ends.

To avoid this, the cable screen in such applications must be connected only on one end to ground potential in the switching cabinet. The cable screen must **not** be connected to the inner ground terminal in the sensor and the outer ground terminal on the housing must **not** be connected to potential equalization!



Information:

The metal parts of the instrument are conductively connected to the inner and outer ground terminal on the housing. This connection is either a direct metallic connection or, in case of instruments with external electronics, a connection via the screen of the special connection cable.

You can find specifications on the potential connections inside the instrument in chapter "*Technical data*".

Connection technology

The voltage supply and signal output are connected via the spring-loaded terminals in the housing.

Connection to the display and adjustment module or to the interface adapter is carried out via contact pins in the housing.

Connection procedure

Proceed as follows:

The procedure applies to instruments without explosion protection.

1. Unscrew the big housing cover
2. Loosen compression nut of the cable gland and remove blind plug

3. Remove approx. 10 cm (4 in) of the cable mantle, strip approx. 1 cm (0.4 in) of insulation from the ends of the individual wires
4. Insert the cable into the sensor through the cable entry

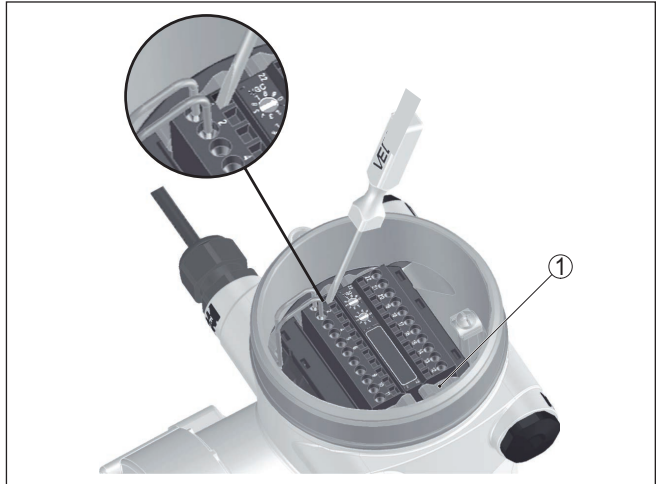

Fig. 8: Connection steps 4 and 5

1 Locking of the terminal blocks

5. Insert a small slotted screwdriver firmly into the rectangular lock openings of the respective connection terminal
6. Insert the wire ends into the round openings of the terminals according to the wiring plan

i Information:

Solid cores as well as flexible cores with cable end sleeves are inserted directly into the terminal openings. In case of flexible cores without end sleeves, press the rectangular lock opening with a small screwdriver; the terminal opening is freed. When the screwdriver is released, the terminal opening closes again.

7. Check the hold of the wires in the terminals by lightly pulling on them
To loosen a line, insert a small slotted screwdriver firmly into the rectangular lock opening according to the illustration
8. Connect the shielding to the internal ground terminal, connect the external ground terminal to potential equalisation
9. Tighten the compression nut of the cable entry gland. The seal ring must completely encircle the cable
10. Screw the housing lid back on

The electrical connection is finished.

i Information:

The terminal blocks are pluggable and can be detached from the electronics. To do this, loosen the two lateral locking levers of the terminal block with a small screwdriver. When loosening the locking,

the terminal block is automatically squeezed out. It must snap in place when re-inserted.

5.2 Connection - Level measurement

Non-Ex instruments and instruments with non-intrinsically safe current output

Electronics and connection compartment - Non-Ex instruments and instruments with non-intrinsically safe current output

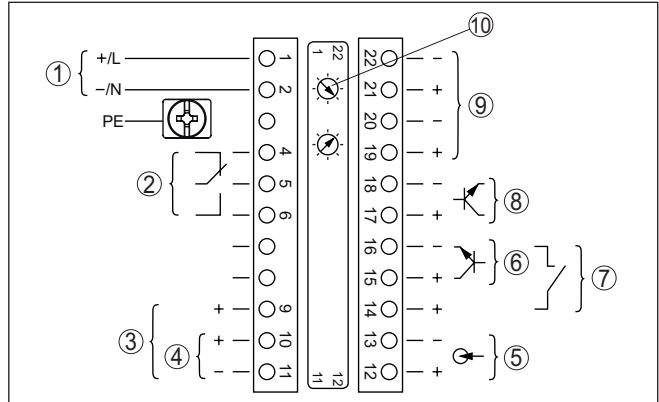

Fig. 9: Electronics and connection compartment with non-Ex instruments and instruments with non-intrinsically safe current output

- 1 Voltage supply
- 2 Relay output
- 3 Signal output 4 ... 20 mA/HART active
- 4 Signal output 4 ... 20 mA/HART passive
- 5 Signal input 4 ... 20 mA
- 6 Switching input for NPN transistor
- 7 Switching input floating
- 8 Transistor output
- 9 Interface for sensor-sensor communication (MGC)
- 10 Setting the bus address for sensor-sensor communication (MGC)²⁾

Adjustment and connection compartment - Non-Ex instruments and instruments with non-intrinsically safe current output

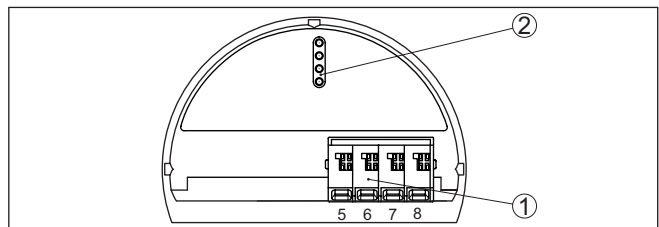

Fig. 10: Adjustment and connection compartment with non-Ex instruments and instruments with non-intrinsically safe current output

- 1 Terminals for the external display and adjustment unit
- 2 Contact pins for the display and adjustment module or interface adapter

²⁾ MGC = Multi Gauge Communication



Instruments with intrinsically safe current output

You can find detailed information on the explosion-protected versions (Ex-ia, Ex-d) in the Ex-specific safety instructions. These safety instructions are part of the scope of delivery and come with the Ex-approved instruments.

Electronics and connection compartment - Instruments with intrinsically safe current output

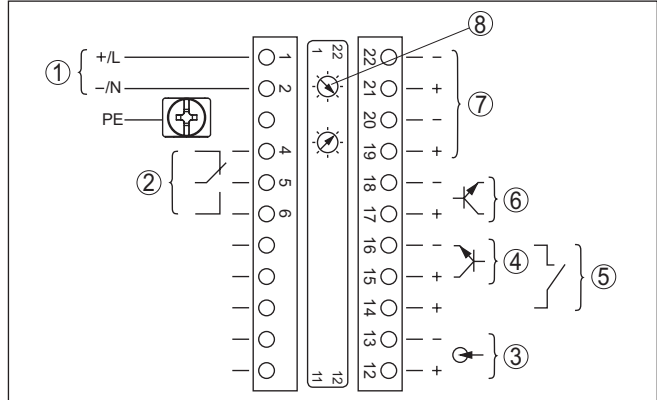

Fig. 11: Electronics and connection compartment (Ex-d) with instruments with intrinsically safe current output

- 1 Voltage supply
- 2 Relay output
- 3 Signal input 4 ... 20 mA
- 4 Switching input for NPN transistor
- 5 Switching input floating
- 6 Transistor output
- 7 Interface for sensor-sensor communication (MGC)
- 8 Setting the bus address for sensor-sensor communication (MGC)³⁾

Adjustment and connection compartment - Instruments with intrinsically safe current output

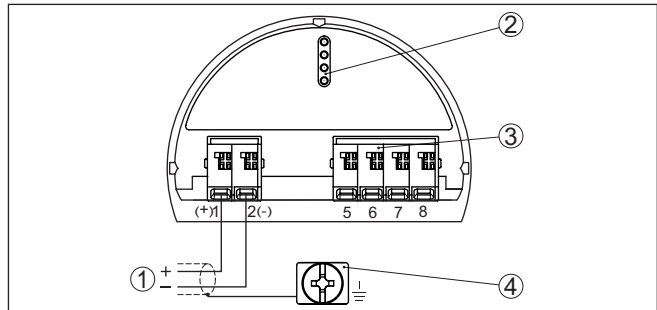

Fig. 12: Adjustment and connection compartment (Ex-ia) with instruments with intrinsically safe current output

- 1 Terminals for intrinsically safe signal output 4 ... 20 mA/HART (active)
- 2 Contact pins for the display and adjustment module or interface adapter
- 3 Terminals for the external display and adjustment unit
- 4 Ground terminal

³⁾ MGC = Multi Gauge Communication

5.3 Connection - Level detection

Non-Ex instruments and instruments with non-intrinsically safe current output

Electronics and connection compartment - Non-Ex instruments and instruments with non-intrinsically safe current output

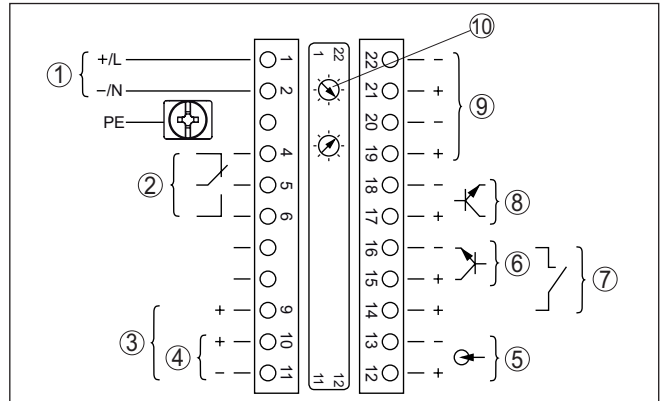

Fig. 13: Electronics and connection compartment with non-Ex instruments and instruments with non-intrinsically safe current output

- 1 Voltage supply
- 2 Relay output
- 3 Signal output 8/16 mA/HART active
- 4 Signal output 8/16 mA/HART Multidrop passive
- 5 Signal input 4 ... 20 mA
- 6 Switching input for NPN transistor
- 7 Switching input floating
- 8 Transistor output
- 9 Interface for sensor-sensor communication (MGC)
- 10 Setting the bus address for sensor-sensor communication (MGC)⁴⁾

Adjustment and connection compartment - Non-Ex instruments and instruments with non-intrinsically safe current output

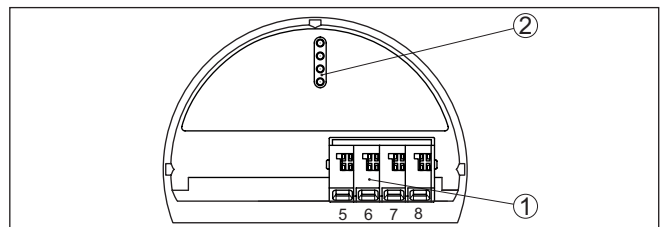

Fig. 14: Adjustment and connection compartment with non-Ex instruments and instruments with non-intrinsically safe current output

- 1 Terminals for the external display and adjustment unit
- 2 Contact pins for the display and adjustment module or interface adapter

Connection to a PLC

If inductive loads or stronger currents are switched through, the gold plating on the relay contact surface will be permanently damaged. The contact is then no longer suitable for switching low-voltage circuits.

⁴⁾ MGC = Multi Gauge Communication

Inductive loads also result from the connection to a PLC input or output and/or in combination with long cables. It is imperative that you take measures to extinguish sparks to protect the relay contact (e.g. Z diode) or the transistor or 8/16 mA output.

Instruments with intrinsically safe current output



You can find detailed information on the explosion-protected versions (Ex-ia, Ex-d) in the Ex-specific safety instructions. These safety instructions are part of the scope of delivery and come with the Ex-approved instruments.

Electronics and connection compartment - Instruments with intrinsically safe current output

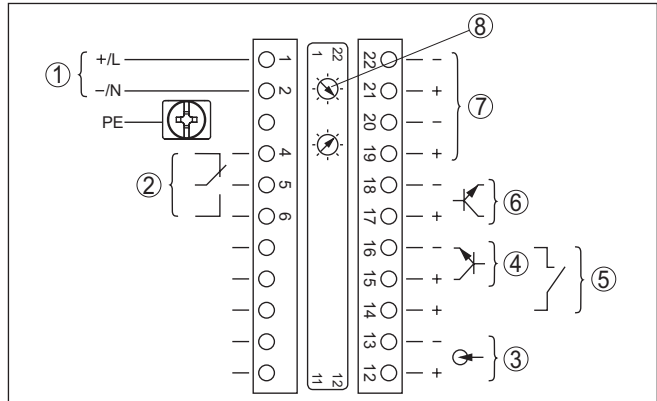

Fig. 15: Electronics and connection compartment (Ex-d) with instruments with intrinsically safe current output

- 1 Voltage supply
- 2 Relay output
- 3 Signal input 4 ... 20 mA
- 4 Switching input for NPN transistor
- 5 Switching input floating
- 6 Transistor output
- 7 Interface for sensor-sensor communication (MGC)
- 8 Setting the bus address for sensor-sensor communication (MGC)⁵⁾

⁵⁾ MGC = Multi Gauge Communication

Adjustment and connection compartment - Instruments with intrinsically safe current output

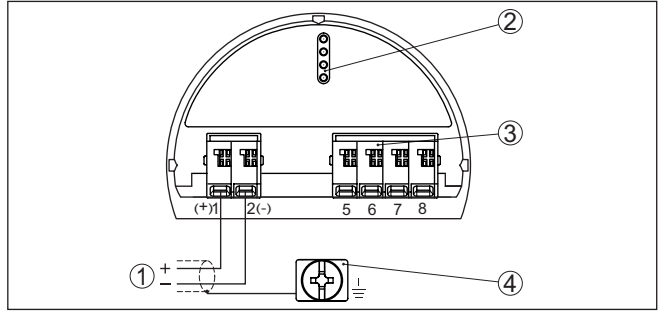

Fig. 16: Adjustment and connection compartment (Ex-ia) with instruments with intrinsically safe current output

- 1 Terminals for intrinsically safe signal output 8/16 mA/HART (Multidrop) active
- 2 Contact pins for the display and adjustment module or interface adapter
- 3 Terminals for the external display and adjustment unit
- 4 Ground terminal

Connection to a PLC

If inductive loads or stronger currents are switched through, the gold plating on the relay contact surface will be permanently damaged. The contact is then no longer suitable for switching low-voltage circuits.

Inductive loads also result from the connection to a PLC input or output and/or in combination with long cables. It is imperative that you take measures to extinguish sparks to protect the relay contact (e.g. Z diode) or the transistor or 8/16 mA output.

5.4 Connection - Summation

To measure the level in very high vessels, multiple instruments can be cascaded.

Cascading means that two or several instruments are connected which can together cover a longer measuring range.

The instrument acts as Primary and all other instruments operate as Secondaries.

The pulse rates of all instruments are summed in the Primary instrument and converted into a common signal.

The Primary instrument must have the function "Level". For this purpose, select under the menu item "Setup - Application" the function "Level".

Set the address setting (MGC) on the Primary instrument to "99".

For this, the Secondary instruments must be defined as "Summation Secondary". Select under the menu item "Setup - Application" the function "Summation Secondary".

The address setting (MGC) on the Secondary instruments can be freely selected. Only the address "99" is reserved for the Primary instrument.

Electronics and connection compartment - summation

**Note:**

Make sure that all instruments are using the same software version. Software version 2.0 is not downward-compatible.

Connect the instruments according to the following wiring plan:

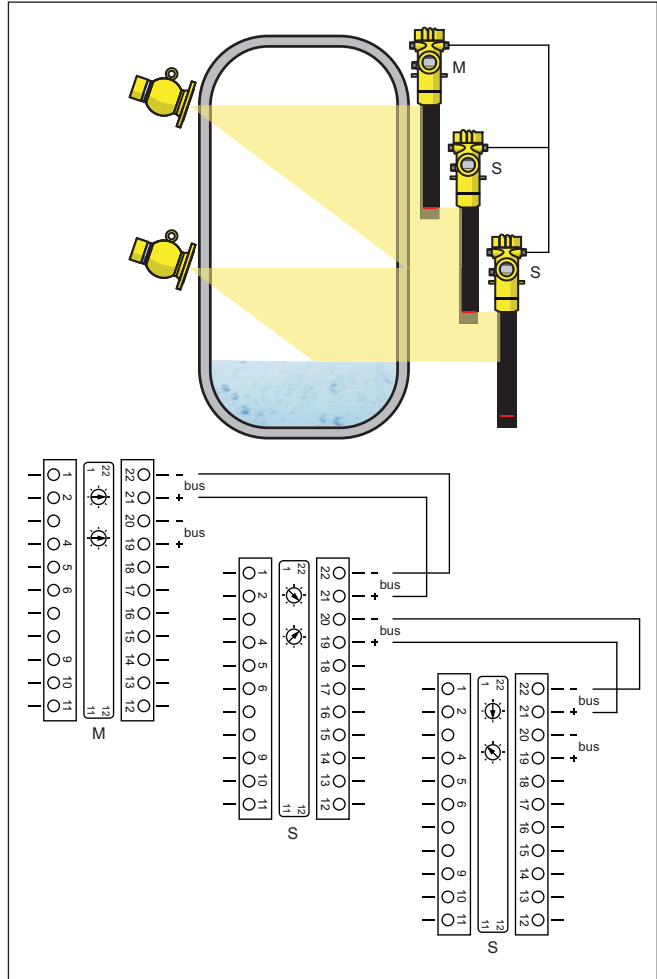

Fig. 17: Electronics and connection compartment with cascading of several instruments.

M Primary instrument

S Secondary instrument

**Information:**

For example, a radial connection would be also possible as an alternative. Take note of the polarity.

The selection of the two terminal pairs is individual.

6 Set up with the display and adjustment module

Mount/dismount display and adjustment module

6.1 Insert display and adjustment module

The display and adjustment module can be inserted into the sensor and removed again at any time. It is not necessary to interrupt the voltage supply.

Proceed as follows:

1. Unscrew the small housing cover
2. Place the display and adjustment module in the desired position on the electronics (you can choose any one of four different positions - each displaced by 90°)
3. Press the display and adjustment module onto the electronics and turn it to the right until it snaps in
4. Screw housing lid with inspection window tightly back on

Disassembly is carried out in reverse order.

The display and adjustment module is powered by the sensor, an additional connection is not necessary.

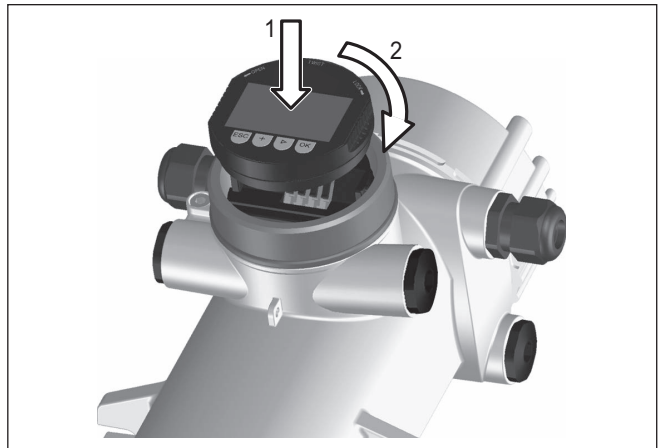

Fig. 18: Insert display and adjustment module



Note:

If you intend to retrofit the instrument with a display and adjustment module for continuous measured value indication, a higher lid with an inspection glass is required.

6.2 Adjustment system

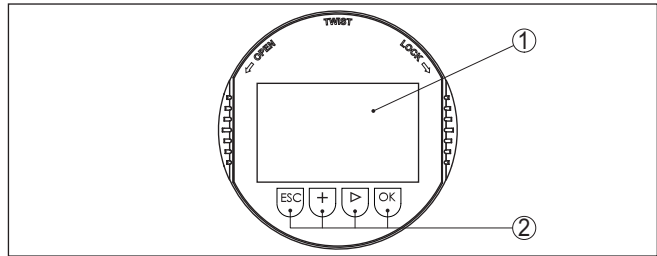

Fig. 19: Display and adjustment elements

- 1 LC display
- 2 Adjustment keys

Key functions

- **[OK]** key:
 - Move to the menu overview
 - Confirm selected menu
 - Edit parameter
 - Save value
- **[>]** key:
 - Change measured value presentation
 - Select list entry
 - Select menu items
 - Select editing position
- **[+]** key:
 - Change value of the parameter
- **[ESC]** key:
 - Interrupt input
 - Jump to next higher menu

Operating system - Keys direct

The instrument is operated via the four keys of the display and adjustment module. The individual menu items are shown on the LC display. You can find the function of the individual keys in the previous illustration.

Adjustment system - keys via magnetic pen

With the Bluetooth version of the display and adjustment module you can also adjust the instrument with the magnetic pen. The pen operates the four keys of the display and adjustment module right through the closed lid (with inspection window) of the sensor housing.

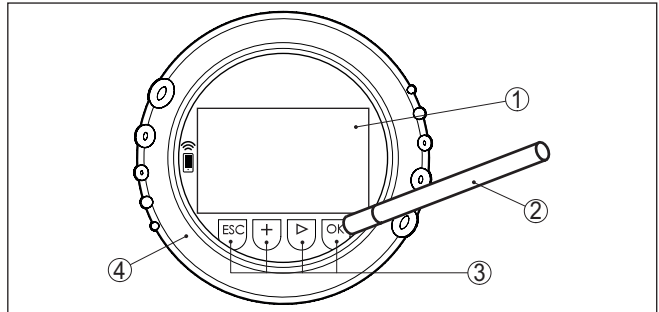

Fig. 20: Display and adjustment elements - with adjustment via magnetic pen

- 1 LC display
- 2 Magnetic pen
- 3 Adjustment keys
- 4 Lid with inspection window

Time functions

When the **[+]** and **[->]** keys are pressed quickly, the edited value, or the cursor, changes one value or position at a time. If the key is pressed longer than 1 s, the value or position changes continuously.

When the **[OK]** and **[ESC]** keys are pressed simultaneously for more than 5 s, the display returns to the main menu. The menu language is then switched over to "English".

Approx. 60 minutes after the last pressing of a key, an automatic reset to measured value indication is triggered. Any values not confirmed with **[OK]** will not be saved.

6.3 Parameter adjustment - Level measurement

The instrument is adapted to the application conditions via the parameter adjustment. The parameter adjustment is carried out with an adjustment menu.

Instrument start



Caution:

During the first setup or after an instrument reset the instrument starts with preset standard values. These value are not suitable for your application and must be replaced by real values.

Carry out a setup in the sequence described in the following.

Main menu

The main menu is divided into five sections with the following functions:

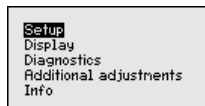

Setup: Settings, e.g. for measurement loop name, isotope, application, background radiation, adjustment, signal output

Display: Settings, for example language, measured value display

Diagnosis: Information, for example, of device status, peak value, simulation

Additional adjustments: Instrument unit, reset, date/time, copying function

Info: Instrument name, hardware and software version, date of manufacture, instrument features

Procedure

Check if the correct language is already set for the display. If not, you can change the language in the menu item "*Display - Menu language*".

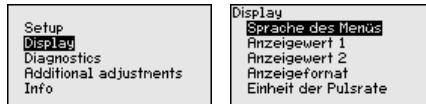

Start with the setup of FIBERTRAC 32.

In the main menu item "*Setup*", the individual submenu items should be selected one after the other and provided with the correct parameters to ensure optimum adjustment of the measurement. The procedure is described in the following.

Stick with the normal sequence of the menu items as closely as possible.

6.3.1 Setup

Measurement loop name

In this menu item you can assign an unambiguous name to the sensor or measurement loop. Push the "**OK**" key to start the editing. With the "+" key you change the sign and with the "->" key you jump to the next position.

You can enter names with max. 19 characters. The character set comprises:

- Capital letters from A ... Z
- Numbers from 0 ... 9
- Special characters + - / _ blanks

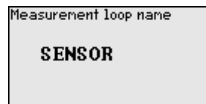

Isotope

In this menu item you can adjust the FIBERTRAC 32 to the isotope installed in the source container.

For this purpose, check which isotope is in the source container. You can find this information on the type label of the source container.

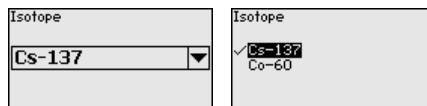

Through this selection, the sensitivity of the sensor is adapted perfectly to the isotope. The normal reduction of source activity through radioactive decay is thus taken into account.

The FIBERTRAC 32 requires this information for the automatic decay compensation. This ensures error-free measurement over the entire lifetime of the gamma emitter - an annual recalibration is not necessary.

Enter the requested parameters via the appropriate keys, save your settings with **[OK]** and jump to the next menu item with the **[ESC]** and the **[->]** key.

Application

Enter here, the respective application.

This menu item enables adaptation of the sensor to the requested application. You can choose between the following applications: "Level", "Point level" or "Summation Secondary".

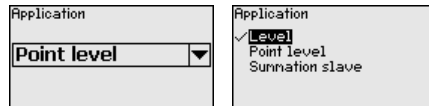

Background radiation

The natural radiation on earth influences the accuracy of the measurement.

With this menu item the natural background radiation can be faded out.

For this purpose, the FIBERTRAC 32 measures the natural background radiation and sets the pulse rate to zero.

In the future, the pulse rate from this background radiation will be automatically deducted from the total pulse rate. This means: only the component of the pulse rate originating from the source will be displayed.

The source container must be closed for this setting.

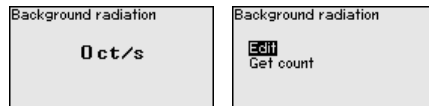

Units

In this menu item you can select the units of the process value and the temperature.

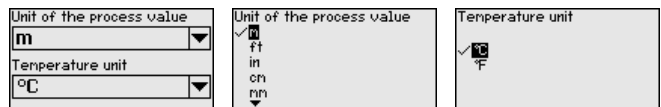

Adjustment

In this menu item you can enter the measuring range (min. and max. process value) of the sensor.

These settings influence the current output of the sensor.

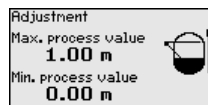

Enter in the menu window "Max. process value" the max. level (full), for example in "m". This corresponds to an output current of 20 mA.

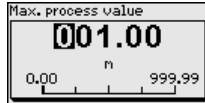

Enter in the menu window "Min. process value" the min. level (empty), for example in "m". This corresponds to an output current of 4 mA.

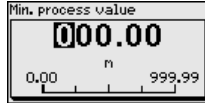

Linearisation

In this menu item you can carry out the adjustment of the sensor.



Caution:

During the first setup or after an instrument reset, the linearisation stands at the preset value pair (90000 ct/s \pm 0 % and 0 ct/s \pm 100 %). These values are not suitable for your application and must be replaced by real values. Delete this value pair in the following procedure and carry out the linearisation.

Due to the measuring principle itself, there is no linear relationship between pulse rate and level. Hence, this adjustment (i.e. linearisation) must in any case be carried out.

If you have a non-linear vessel (e.g. spherical tank), you have to carry out this adjustment with as many points as possible.



Note:

If you cannot fill the vessel with the original medium, it is also possible to carry out the adjustment with water.

Prerequisites:

Radiation is switched on - Source container is set to "ON"

The vessel is either completely filled (100 %) or completely emptied (0 %).

Depending on whether the vessel is full or empty, you can first carry out the full or the empty adjustment. The FIBERTRAC 32 sorts the points automatically according to their level.

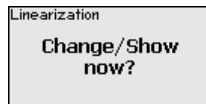

Select "Show table" to display and edit the linearisation points.

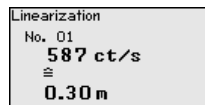
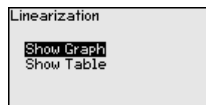

Select "Linearisation - New" to enter the first point.

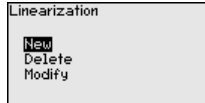

Select "Determine count rate" to enter the first point.

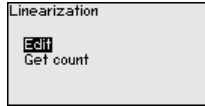

The determination of the actual count rate lasts 2 minutes. After the count rate has been determined, you can accept the value (ct/s).

The count rate is stated in ct/s. This is the number of counts per second, i.e. the measured radioactive radiation dose actually reaching the sensor.

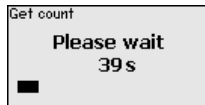

Enter now the corresponding level (m).

By doing so, you assign a corresponding level to the actual count rate.

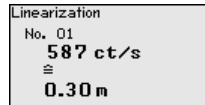
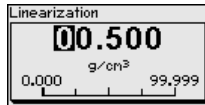

Accept the value pair with "OK".

Depending on whether you started with a full or an empty vessel, you have to continue emptying or filling the vessel.

Carry out such a linearisation with several different filling heights even if you have a linear vessel.

By doing so, you can influence the measurement reliability of the sensor. The more linearisation points you enter and the bigger the difference between the first and the last linearisation point, the more reliable the measurement will be.

If you have a non-linear vessel (e.g. spherical tank), you have to carry out this adjustment with as many points as possible.

A maximum of 32 linearisation points is possible.

Show diagram

This menu item is only available if a linearization was already carried out.

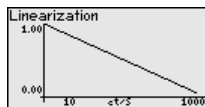

Show table

In this menu item you can show the individual value pairs of the linearization.

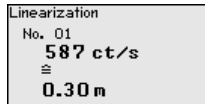

Linearization - Delete

You can also delete individual linearization points.

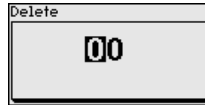

Linearization - Modify

You can also modify individual linearization points.

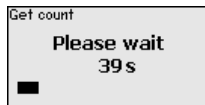
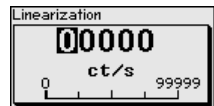
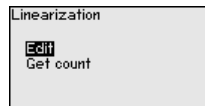
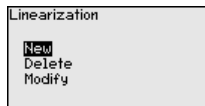

Damping

In this menu item you can adjust the damping of the sensor. With it you can suppress fluctuations in the measured value indication, caused e.g. by an agitated product surface. This time can be between 1 and 1200 seconds. Keep in mind that the reaction time also increases and the instrument reacts to quick level changes with a delay. Generally a time of approximately 60 seconds is sufficient to smooth the measured value indication.

With the setting "Automatic", the instrument itself calculates a suitable damping on the basis of the adjustment and the measured value changes. This setting is particularly suitable for application where fast and slow level changes occur.

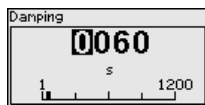
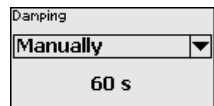
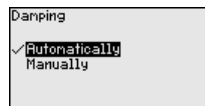
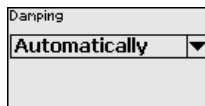

Real value correction

If you know the level at a certain height, you can enter in this menu item the determined real level to correct the measured value. The function shifts the linearization curve to this determined point.

With this procedure the measurement can be adapted exactly to the conditions in the vessel.

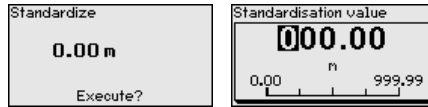

Current output mode

In this menu item you can define the characteristics of the sensor and its behaviour in case of a fault.

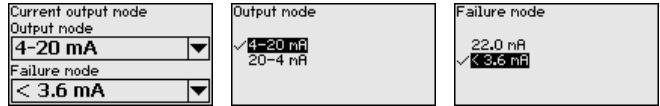

Current output, min./max.

In this menu item you can define the behaviour of the current output. You can determine the current with min. and max. level separately.

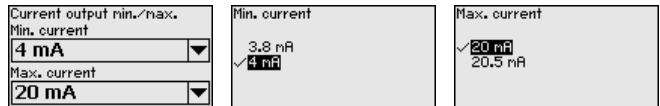

X-ray alarm

Radiation from external sources can influence the measuring result of the sensor.

Possible external radiation sources can be, for example, a weld joint test on a neighbouring facility or other radiometric instruments.

An X-ray alarm is triggered if the impulses (ct/s) are more than 25 % above the max. value from the linearization table.

This fault message is only output for the period of the increased X-ray radiation. Then the fault message is automatically reset.

In this menu item you can determine the behaviour of the sensor when external radiation sources appear.

You can choose whether the sensor should output modulated current (dithering) or the set fault current in case external radiation appears.

In the case of modulated measuring current (dithering), the last valid current value is maintained and the current output modulates a square-wave voltage ± 1 mA around this value.

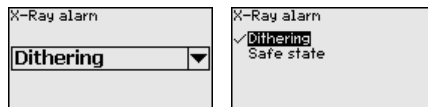

Relay

In this menu item you can activate the relay output and determine its function as well as the switching points.

When the output of the process values is set, you can choose between overflow and dry run protection.

The relay outputs of the sensor react accordingly.

You can choose "no" reference value. In this case, the relay output operates as fail safe relay.

This does not apply if "X-ray alarm" is selected as reference value. In this case the fault message is not active.

- None - Relay operates as fail safe relay
- Electronics temperature
- Process value

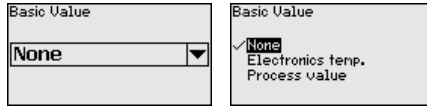

Push the [→] button, to reach the relay settings.

Example for the setting the process value

First of all select the requested mode (overflow or dry run protection).

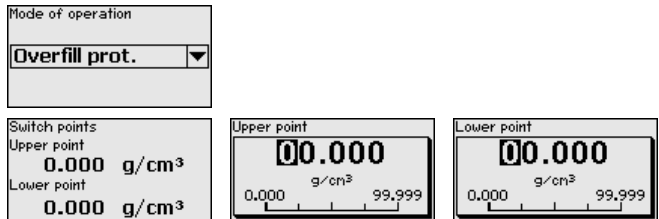

Caution:

Independent of the selected reference value, the relay will deenergize in case of failure.

This does not apply if "X-ray alarm" is selected as reference value. In this case the fault message is not active.

Lock/Unlock adjustment

In the menu item "Lock/unlock adjustment", you can protect the sensor parameters against unauthorized or inadvertent modification. The sensor is locked/unlocked permanently.

With locked instrument, only the following adjustment functions are possible without entering a PIN:

- Select menu items and show data
- Read data from the sensor into the display and adjustment module



Before you lock the sensor in unlocked condition, you can modify the four-digit PIN number.

Keep the entered PIN number in mind. Operation of the sensor is only possible with this PIN number.



Caution:

When the PIN is active, adjustment via PACTware/DTM as well as other systems is also blocked.

In delivery status, the PIN is **0000**.

Call our service department if you have modified and forgotten the PIN.

6.3.2 Display

In the main menu point "Display", the individual submenu points should be selected one after the other and provided with the correct parameters to ensure the optimum adjustment of the display. The procedure is described in the following.

Menu language

This menu item enables the setting of the requested national language.

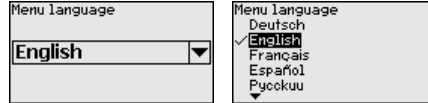

In delivery status, the sensor is set to the ordered national language. If no language is preset, you will be asked during setup.

Displayed value

With this parameter you can change the indication of the display. You can choose if the display should show the actual pulse rate, the output current, the electronics temperature or the percentage value.

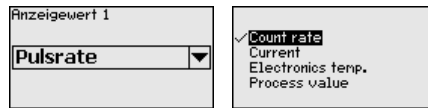

6.3.3 Diagnostics

Sensor status

In this menu item, you can enquire the status of your sensor. In normal operation, the sensor displays the message "OK". In case of fault, you will find the corresponding fault code here.

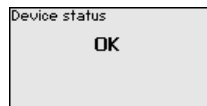

Peak value indicator

The peak value function holds the max. and min. values during operation.

- Pulse rates - min./max.
- Temperature - min./max./actually

Peak values	
Pulse/sec. min.	0ct/s
Pulse/sec. max.	35467ct/s
T _r -min.	21,5 °C
T _r -max.	31,5 °C
T _r -act.	31,0 °C

Adjustment data

Here you can retrieve the adjustment value of the sensor. This is the percentage value of the difference of the min. and max. adjustment points (Delta I). The value is an indication for the reliability and non-repeatability of the measurement.

The higher the difference between the two adjustment points, the higher the differential value (Delta I) and the more reliable the

measurement. A Delta I value below 10 % is an indication for a critical measurement.

To increase the Delta I value, you have to increase the distance of the min. and max. adjustment points in the linearization.

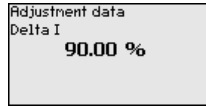

Simulation

In this menu item you can simulate measured values via the current output. This allows the signal path to be tested, e.g. through downstream indicating instruments or the input card of the control system.

You can simulate different values:

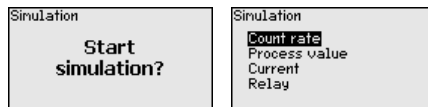

Pulse rate of the sensor



Process value

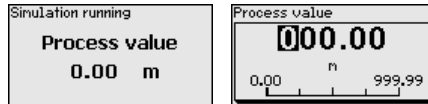

Current output

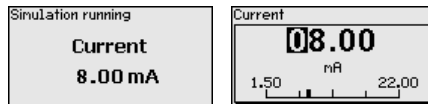

Switching function of the relay

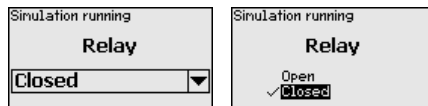

Information:

The simulation is terminated automatically 60 minutes after the last key has been pressed.

6.3.4 Additional adjustments

Date/Time

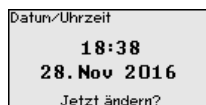

In this menu item you can set the actual date, time and display format.

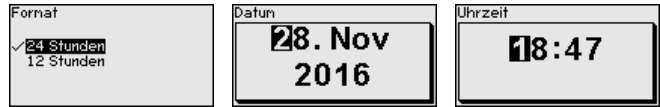

Reset

When a reset is carried out, all settings (with only a few exceptions) are reset. The exceptions are: PIN, language, SIL and HART mode.



The following reset functions are available:

Basic settings: Resetting of the parameter adjustments to default values at the time of shipment. Order-specific settings are deleted.

Default settings: Resetting of the parameter adjustment like under "Basic settings". In addition, special parameters are reset to default values. Order-specific settings are deleted.

Peak values of measured value: Resetting of the parameter adjustments in the menu item "Setup" to the default values of the respective instrument. Order-specific settings remain but are not taken over into the current parameters.

Peak values of temperature: Resetting of the measured min. and max. temperatures to the actual measured value.

The following table shows the default values of the instrument. The values apply for the application "Level". First of all you have to select the application.

Depending on the instrument version, not all menu items may be available or they may be differently assigned:

Menu	Menu item	Default value	
Setup	Measurement loop name	Sensor	
	Isotope	Cs-137	
	Application	Level	
	Adjustment	0 %, 100 %	
	Linearisation		0 ct/s \pm 100 %
			90000 ct/s \pm 0 %
	Background radiation	0 ct/s	
	Process value unit	%	
	Temperature unit	° C	
	Damping	60 s (manually)	
	Real value correction	0	
	Current output mode	4 ... 20 mA, < 3.6 mA	
	Current output, min./max.	Min. current 3.8 mA, max. current 20.5 mA	
	X-ray alarm	Modulated measuring current	
	Reference value - Relay	None	
	Mode	Overfill protection	
	Upper switching point - Process value	0 %	
	Lower switching point - Process value	0 %	
	Upper switching point - Temperature	50 °C	
	Upper switching point - Temperature	25 °C	
	Lock adjustment	Released	
	Address - Summation Secondary	free	
	Display	Language	Selected language
Displayed value		Pulse rate	
Display unit		ct/s	
Additional adjustments	Temperature unit	°C	
	Linearisation curve	Empty	
	HART mode	Standard Address 0	

HART mode

With this function you can select the mode.

The sensor offers the HART modes standard and multidrop.

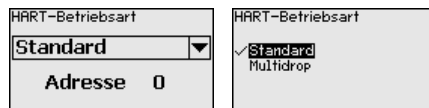

The default setting is standard with address 0.

The mode 'Standard' with the fixed address 0 (factory setting) means output of the measured value as 4 ... 20 mA signal.

In Multidrop mode, several sensors are communicating on one two-wire cable via the HART protocol.

In Multidrop mode, up to 15 sensors can be operated on one two-wire cable. An address between 1 and 15 must be assigned to each sensor.

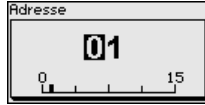

Copy instrument settings With this function

- Load parameter adjustment data from the sensor into the display and adjustment module
- Write parameter adjustment data from the display and adjustment module into the sensor

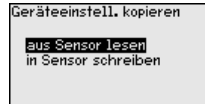
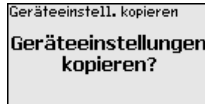

The copied data are permanently saved in an EEPROM memory in the display and adjustment module and remain there even in case of a power failure. From there, they can be written into one or more sensors or kept as backup for a possible sensor exchange.



Note:

Before the data are copied into the sensor, a check is carried out to determine if the data fit the sensor. If the data do not fit, a fault signal is triggered. When data are being written into the sensor, the display shows which instrument type the data originate from and which TAG number this sensor had.

6.3.5 Info

Info

In this menu you will find the following menu items:

- Instrument name - shows instrument name and serial number
- Instrument version - shows hardware and software version of the instrument
- Date of manufacture - shows calibration date and the date of the last change
- Instrument features - shows further instrument features, such as e.g. approval, electronics ...

Examples for info display:

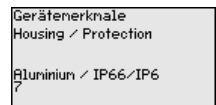

6.4 Parameter adjustment - Summation Secondary

Cascading

To measure the level in very high vessels, multiple instruments can be cascaded.

Cascading means that two or several instruments are connected which can together cover a longer measuring range.

The instrument acts as Primary and all other instruments operate as Secondaries.

The pulse rates of all instruments are summed in the Primary instrument and converted into a common signal.

First of all, define the function of the Secondary instruments before you define the Primary instrument. The Primary instrument can thus immediately recognize the connected Secondaries.

For this, the Secondary instruments must be defined as "Summation Secondary". Select under the menu item " *Setup - Application*" the function "Summation Secondary".

The address setting (MGC) on the Secondary instruments can be freely selected. Only the address "99" is reserved for the Primary instrument.

The Primary instrument must have the function "Level". For this purpose, select under the menu item " *Setup - Application*" the function "Level".

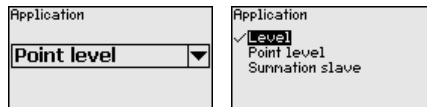

Set the address setting (MGC) on the Primary instrument to "99".

You have to enter the addresses of the Secondary instruments in the list of the Primary instruments. This function is not possible in the supply and adjustment module. To do this you need PACTware with the respective DTM.

Main menu

The main menu is divided into five sections with the following functions:

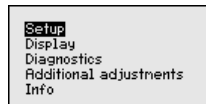

Setup: Settings, e.g. for measurement loop name, isotope, application, background radiation, adjustment, signal output

Display: Settings, for example language, measured value display

Diagnosis: Information, for example, of device status, peak value, simulation

Additional adjustments: Instrument unit, reset, date/time, copying function

Info: Instrument name, hardware and software version, date of manufacture, instrument features

Procedure

Check if the correct language is already set for the display. If not, you can change the language in the menu item "*Display - Menu language*".

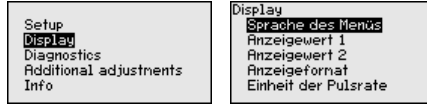

Start with the setup of FIBERTRAC 32.

In the main menu item "*Setup*", the individual submenu items should be selected one after the other and provided with the correct parameters to ensure optimum adjustment of the measurement. The procedure is described in the following.

Stick with the normal sequence of the menu items as closely as possible.

6.4.1 Setup

Measurement loop name

In this menu item you can assign an unambiguous name to the sensor or measurement loop. Push the "**OK**" key to start the editing. With the "+" key you change the sign and with the "->" key you jump to the next position.

You can enter names with max. 19 characters. The character set comprises:

- Capital letters from A ... Z
- Numbers from 0 ... 9
- Special characters + - / _ blanks



Application

Enter here, the respective application.

This menu item enables adaptation of the sensor to the requested application. You can choose between the following applications: "*Level*", "*Point level*" or "*Summation Secondary*".

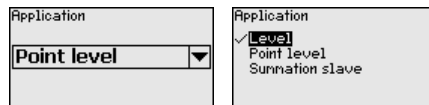

Outputs

In this menu item you can activate the function of the current output.

When the output is activated, the instrument remains in its function as a Secondary, but the 4 ... 20 mA output of the FIBERTRAC 32 can be also used als single instrument.

When the output is active, the instrument has the complete functionality of a level measuring instrument. In this case, continue reading under "*Parameter adjustment/Level measurement*".

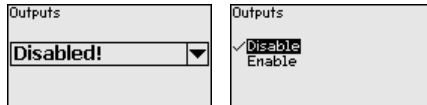

Lock/Unlock adjustment

In the menu item "Lock/unlock adjustment", you can protect the sensor parameters against unauthorized or inadvertent modification. The sensor is locked/unlocked permanently.

With locked instrument, only the following adjustment functions are possible without entering a PIN:

- Select menu items and show data
- Read data from the sensor into the display and adjustment module



Before you lock the sensor in unlocked condition, you can modify the four-digit PIN number.

Keep the entered PIN number in mind. Operation of the sensor is only possible with this PIN number.



Caution:

When the PIN is active, adjustment via PACTware/DTM as well as other systems is also blocked.

In delivery status, the PIN is **0000**.

Call our service department if you have modified and forgotten the PIN.

6.4.2 Additional adjustments

Reset

When a reset is carried out, all settings (with only a few exceptions) are reset. The exceptions are: PIN, language, SIL and HART mode.

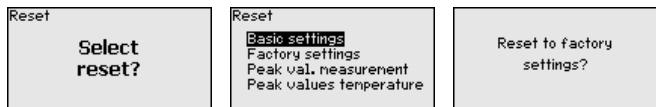

The following reset functions are available:

Basic settings: Resetting of the parameter adjustments to default values at the time of shipment. Order-specific settings are deleted.

Default settings: Resetting of the parameter adjustment like under "Basic settings". In addition, special parameters are reset to default values. Order-specific settings are deleted.

Peak values of measured value: Resetting of the parameter adjustments in the menu item "Setup" to the default values of the respective instrument. Order-specific settings remain but are not taken over into the current parameters.

Peak values of temperature: Resetting of the measured min. and max. temperatures to the actual measured value.

The following table shows the default values of the instrument. The values apply for the application "Summation Secondary". The application must be selected first.

Depending on the instrument version, not all menu items may be available or they may be differently assigned:

Menu	Menu item	Default value	
Setup	Measurement loop name	Sensor	
	Isotope	Cs-137	
	Application	Summation Secondary	
	Outputs	Deactivated	
	Adjustment	0 %, 100 %	
	Linearisation		0 ct/s \pm 100 %
			90000 ct/s \pm 0 %
	Background radiation	0 ct/s	
	Process value unit	%	
	Temperature unit	°C	
	Damping	60 s (manually)	
	Real value correction	0	
	Current output	Deactivated	
	Current output mode	4 ... 20 mA, < 3.6 mA	
	Current output, min./max.	Min. current 3.8 mA, max. current 20.5 mA	
	Reference value - Relay	None	
	Mode	Overfill protection	
	Upper switching point - Process value	0 %	
	Lower switching point - Process value	0 %	
	Upper switching point - Temperature	50 °C	
	Upper switching point - Temperature	25 °C	
	Lock adjustment	Released	
Address - Summation Secondary	free		
Display	Language	Selected language	
	Displayed value	Pulse rate	
	Display unit	ct/s	
Additional adjustments	Temperature unit	°C	
	Linearisation curve	Empty	
	HART mode	Standard Address 0	

6.5 Parameter adjustment - Point level detection

The instrument is adapted to the application conditions via the parameter adjustment. The parameter adjustment is carried out with an adjustment menu.

Instrument start



Caution:

During the first setup or after an instrument reset the instrument starts with preset standard values. These value are not suitable for your application and must be replaced by real values.

Carry out a setup in the sequence described in the following.

Main menu

The main menu is divided into five sections with the following functions:

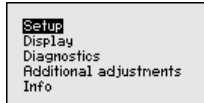

Setup: Settings, e.g. for measurement loop name, isotope, application, background radiation, adjustment, signal output

Display: Settings, for example language, measured value display

Diagnosis: Information, for example, of device status, peak value, simulation

Additional adjustments: Instrument unit, reset, date/time, copying function

Info: Instrument name, hardware and software version, date of manufacture, instrument features

Procedure

Check if the correct language is already set for the display. If not, you can change the language in the menu item "*Display - Menu language*".

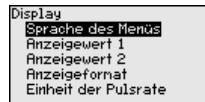
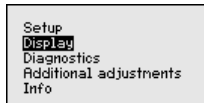

Start with the setup of FIBERTRAC 32.

In the main menu item "*Setup*", the individual submenu items should be selected one after the other and provided with the correct parameters to ensure optimum adjustment of the measurement. The procedure is described in the following.

Stick with the normal sequence of the menu items as closely as possible.

6.5.1 Setup

Measurement loop name

In this menu item you can assign an unambiguous name to the sensor or measurement loop. Push the "**OK**" key to start the editing. With the "+" key you change the sign and with the "->" key you jump to the next position.

You can enter names with max. 19 characters. The character set comprises:

- Capital letters from A ... Z
- Numbers from 0 ... 9
- Special characters + - / _ blanks



Isotope

In this menu item you can adjust the FIBERTRAC 32 to the isotope installed in the source container.

For this purpose, check which isotope is in the source container. You can find this information on the type label of the source container.

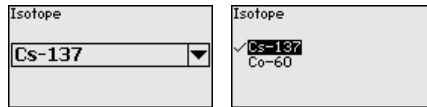

Through this selection, the sensitivity of the sensor is adapted perfectly to the isotope. The normal reduction of source activity through radioactive decay is thus taken into account.

The FIBERTRAC 32 requires this information for the automatic decay compensation. This ensures error-free measurement over the entire lifetime of the gamma emitter - an annual recalibration is not necessary.

Enter the requested parameters via the appropriate keys, save your settings with **[OK]** and jump to the next menu item with the **[ESC]** and the **[->]** key.

Application

Enter here, the respective application.

This menu item enables adaptation of the sensor to the requested application. You can choose between the following applications: "Level", "Point level" or "Summation Secondary".

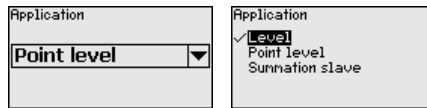

Background radiation

The natural radiation on earth influences the accuracy of the measurement.

With this menu item the natural background radiation can be faded out.

For this purpose, the FIBERTRAC 32 measures the natural background radiation and sets the pulse rate to zero.

In the future, the pulse rate from this background radiation will be automatically deducted from the total pulse rate. This means: only the component of the pulse rate originating from the source will be displayed.

The source container must be closed for this setting.

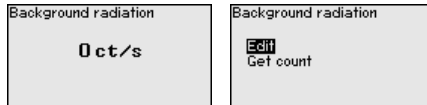

Unit

In this menu item you can select the temperature unit.

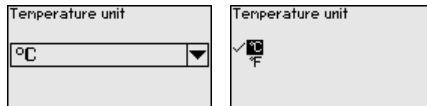

Adjustment mode

in this menu item you can select if you want to carry out a single or double point adjustment on the sensor.

With the double point adjustment, the Delta I value is selected automatically.

We recommend selecting the double point adjustment. To use this, you must be able to change the level of the vessel so as to carry out the adjustment of the sensor with full status (covered) and with empty status (uncovered).

Hence, you will get a very reliable switching point.

With single point adjustment, you have to define the difference between the min. and max. adjustment points (Delta I) yourself during the following setup.

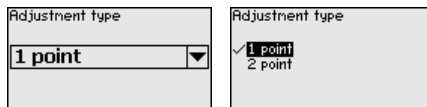

Adjustment "uncovered" (single point adjustment)

This menu item appears only if you have selected "**Single point adjustment**" as adjustment mode (Setup - Adjustment mode).

In this menu item you determine the point at which the FIBERTRAC 32 should switch in uncovered status.

Empty the vessel until the sensor is uncovered.

For this enter the requested pulse rate manually or let the rate be determined by FIBERTRAC 32. Automatic determination of the pulse rate should be given preference.

The count rate is stated in ct/s. This is the number of counts per second, i.e. the measured radioactive radiation dose actually reaching the sensor.

Prerequisites:

- Radiation is switched on - Source container is set to "ON"
- There is no medium between source container and sensor



You can enter the value for "Adjustment uncovered" (ct/s) manually.

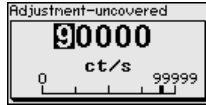

You can have the value for "Adjustment uncovered" determined by FIBERTRAC 32.



Delta I (single point adjustment)

This menu item appears only if you have selected "Single point adjustment" as adjustment mode (Setup - Adjustment mode).

In this menu item you can adjust at which percentage value of the max. pulse rate the sensor should switch over.

Since in most cases the radiation is almost completely absorbed when the sensor is covered, the pulse rate when the sensor is covered is very low.

The change between the two statuses is sufficiently clear.

Hence a percentage value of 90 % for the Delta I value is recommended.

You select lower values for sensitive detection of material cones or buildup which cause only partial absorption of the radiation.

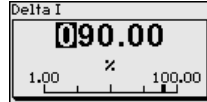
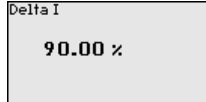

Adjustment "covered" (two-point adjustment)

This menu item appears only if you have selected "Two point adjustment" as adjustment mode (Setup - Adjustment mode).

In this menu item you can set the min. pulse rate (ct/s) at which the sensor should switch over.

Fill the vessel until the FIBERTRAC 32 is covered.

You thus get the min. pulse rate (ct/s) for the "covered" adjustment.

Enter the requested pulse rate manually or let the rate be determined by FIBERTRAC 32. Automatic determination of the pulse rate should be given preference.

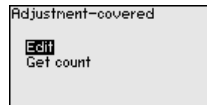
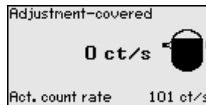

You can enter the adjustment point (ct/s) manually.

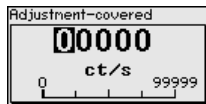

You can let the adjustment point be determined by FIBERTRAC 32.



Adjustment "uncovered" (two-point adjustment)

This menu item appears only if you have selected "**Two point adjustment**" as adjustment mode (Setup - Adjustment mode).

In this menu item you can set the max. pulse rate (ct/s) at which the sensor should switch over.

Empty the vessel until the FIBERTRAC 32 is uncovered.

You thus get the max. pulse rate (ct/s) for the "uncovered" adjustment.

Enter the requested pulse rate manually or let the rate be determined by FIBERTRAC 32. Automatic determination of the pulse rate should be given preference.

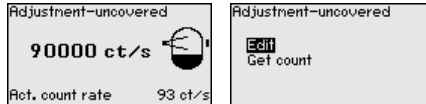

You can enter the adjustment point (ct/s) manually.

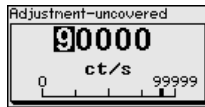

You can let the adjustment point be determined by FIBERTRAC 32.



Current output mode

In this menu item you can select the switching behaviour of the sensor.

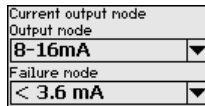

You can choose between an 8 - 16 mA characteristics or a 16 - 8 mA characteristics.

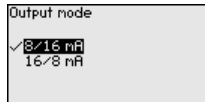

In this menu item you can also define the switching behaviour in case of fault. You can select if the current output should output 22 mA or < 3.6 mA in case of fault.

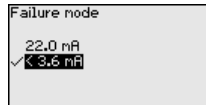

Relay

In this menu item you can select which mode the sensor should operate in.

You can choose between overflow and dry run protection.

The relay outputs of the sensor react accordingly.

Overflow protection = the relay will deenergise (safe state) when the max. level is reached.

Dry run protection = the relay will deenergise (safe state) when the min. level is reached.

Make sure that you have selected the correct characteristics. See menu item "Setup - Current output mode".

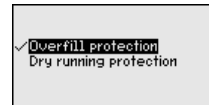
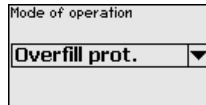

Lock/Unlock adjustment

In the menu item "Lock/unlock adjustment", you can protect the sensor parameters against unauthorized or inadvertent modification. The sensor is locked/unlocked permanently.

With locked instrument, only the following adjustment functions are possible without entering a PIN:

- Select menu items and show data
- Read data from the sensor into the display and adjustment module

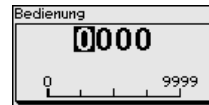

Before you lock the sensor in unlocked condition, you can modify the four-digit PIN number.

Keep the entered PIN number in mind. Operation of the sensor is only possible with this PIN number.



Caution:

When the PIN is active, adjustment via PACTware/DTM as well as other systems is also blocked.

In delivery status, the PIN is **0000**.

Call our service department if you have modified and forgotten the PIN.

6.5.2 Display

In the main menu point "Display", the individual submenu points should be selected one after the other and provided with the correct parameters to ensure the optimum adjustment of the display. The procedure is described in the following.

Menu language

This menu item enables the setting of the requested national language.

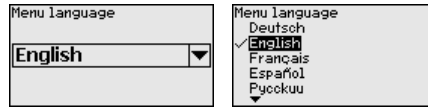

In delivery status, the sensor is set to the ordered national language. If no language is preset, you will be asked during setup.

Displayed value

With this parameter you can change the indication of the display.

You can choose if the display should show the actual pulse rate or the electronics temperature.

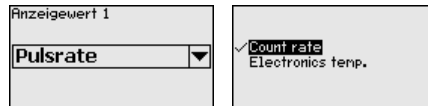
**6.5.3 Diagnostics****Sensor status**

In this menu item, you can enquire the status of your sensor. In normal operation, the sensor displays the message "OK". In case of fault, you will find the corresponding fault code here.

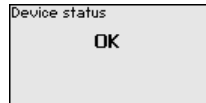
**Peak value indicator**

The peak value function holds the max. and min. values during operation.

- Pulse rates - min./max.
- Temperature - min./max./actually

Peak values	
Pulse/sec. min.	0ct/s
Pulse/sec. max.	35467ct/s
T.-min.	21,5 °C
T.-max.	31,5 °C
T.-act.	31,0 °C

Adjustment data

Here, you can retrieve the adjustment value of the sensor. This is the percentage value of the max. pulse rate at which the sensor switches over.

If you have carried out a single point adjustment, this is the entered value. With a two-point adjustment, this is the calculated value.

The value is an indication for the reliability and non-repeatability of the switching point.

The greater the difference in the pulse rate between covered and uncovered status, the greater the differential value (Delta I) and the more reliable the measurement. The automatically calculated damping is also oriented around the Delta I value. The higher the value, the lower the damping.

A Delta I value below 10 % is an indication for a critical measurement.

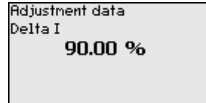

Simulation

In this menu item you can simulate measured values via the current output. This allows the signal path to be tested, e.g. through downstream indicating instruments or the input card of the control system.

You can simulate different values:

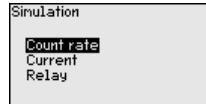
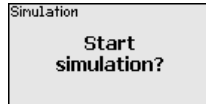

Pulse rate of the sensor

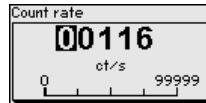
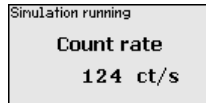

Current output

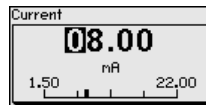
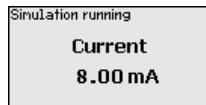

Switching function of the relay

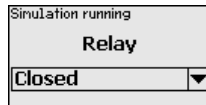

Information:

The simulation is automatically terminated 10 minutes after the last pressing of a key.

Calculated damping

The sensor calculates a suitable integration time automatically.

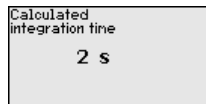

6.5.4 Additional adjustments

Date/Time

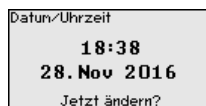

In this menu item you can set the actual date, time and display format.

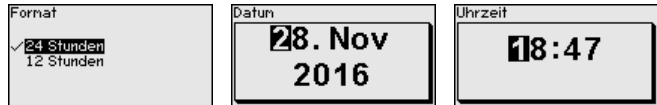

Reset

When a reset is carried out, all settings (with only a few exceptions) are reset. The exceptions are: PIN, language, SIL and HART mode.

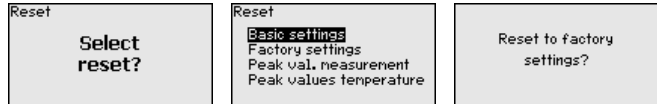

The following reset functions are available:

Basic settings: Resetting of the parameter adjustments to default values at the time of shipment. Order-specific settings are deleted.

Default settings: Resetting of the parameter adjustment like under "Basic settings". In addition, special parameters are reset to default values. Order-specific settings are deleted.

Peak values of measured value: Resetting of the parameter adjustments in the menu item "Setup" to the default values of the respective instrument. Order-specific settings remain but are not taken over into the current parameters.

Peak values of temperature: Resetting of the measured min. and max. temperatures to the actual measured value.

The following table shows the default values of the instrument. The values apply for the application "Limit level". First of all you have to select the application.

Depending on the instrument version, not all menu items may be available or they may be differently assigned:

Menu	Menu item	Default value
Setup	Measurement loop name	Sensor
	Isotope	Cs-137
	Application	Limit level
	Adjustment mode	Single point adjustment
	Adjustment - uncovered	90000 ct/s
	Adjustment - covered	9000 ct/s only with two-point adjustment
	Delta I	90 %
	Background radiation	0 ct/s
	Temperature unit	°C
	Damping	Is calculated automatically by the instrument
	Current output mode	8/16 mA, < 3.6 mA
	X-ray alarm	Modulated measuring current
	Mode - Relay	Overfill protection
Lock adjustment	Released	

Menu	Menu item	Default value
Display	Language	Selected language
	Displayed value	Pulse rate
Additional adjustments	Temperature unit	°C
	HART mode	Standard

HART mode

With this function you can select the mode.

The sensor offers the HART modes standard and multidrop.

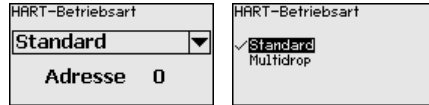

The default setting is standard with address 0.

If the measured value is output via the 4 ... 20 mA output, you must not switch over to HART Multidrop.

The mode 'Standard', with fixed address 0 (factory setting), means output of the measured value as 8/16 mA signal.

In Multidrop mode, several sensors are communicating on one two-wire cable via the HART protocol.

In Multidrop mode, up to 15 sensors can be operated on one two-wire cable. An address between 1 and 15 must be assigned to each sensor.

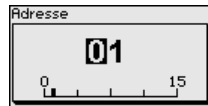

Copy instrument settings

With this function

- Load parameter adjustment data from the sensor into the display and adjustment module
- Write parameter adjustment data from the display and adjustment module into the sensor

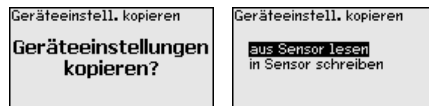

The copied data are permanently saved in an EEPROM memory in the display and adjustment module and remain there even in case of a power failure. From there, they can be written into one or more sensors or kept as backup for a possible sensor exchange.



Note:

Before the data are copied into the sensor, a check is carried out to determine if the data fit the sensor. If the data do not fit, a fault signal is triggered. When data are being written into the sensor, the display shows which instrument type the data originate from and which TAG number this sensor had.

6.5.5 Info

Info

In this menu you will find the following menu items:

- Instrument name - shows instrument name and serial number
- Instrument version - shows hardware and software version of the instrument
- Date of manufacture - shows calibration date and the date of the last change
- Instrument features - shows further instrument features, such as e.g. approval, electronics ...

Examples for info display:

Softwareversion 2.0.1 Hardwareversion 1.06	Kalibrierdatum 3. April 2013 Letzte Änderung 4. Nov 2016	Gerätemerkmale Housing / Protection Aluminium / IP66/IP67
---	---	---

6.6 Saving the parameterisation data

On paper

We recommend writing down the adjustment data, e.g. in this operating instructions manual, and archiving them afterwards. They are thus available for multiple use or service purposes.

In the display and adjustment module

If the instrument is equipped with a display and adjustment module, the parameter adjustment data can be saved therein. The procedure is described in menu item "*Copy device settings*".

7 Setup with smartphone/tablet (Bluetooth)

7.1 Preparations

System requirements

Make sure that your smartphone/tablet meets the following system requirements:

- Operating system: iOS 8 or newer
- Operating system: Android 5.1 or newer
- Bluetooth 4.0 LE or newer

Download the VEGA Tools app from the "Apple App Store", "Google Play Store" or "Baidu Store" to your smartphone or tablet.

7.2 Connecting

Change sensor PIN

For a communication with the sensor, the default setting of the sensor PIN (0000) must be changed to your own sensor PIN. To do this, go to the menu item "Lock adjustment".

An authentication by means of the sensor PIN via the adjustment app is only possible after the default sensor PIN "0000" has been changed in the sensor.

After the sensor PIN has been changed, sensor adjustment can be enabled again. For access (authentication) with Bluetooth, the PIN is still effective.

Connecting

Start the VEGA Tools app and select the function "Setup". The smartphone/tablet searches automatically for Bluetooth-capable instruments in the area.

The message "Searching ..." is displayed.

The found instruments will be listed on the left side of the adjustment window. The search is continued automatically.

Select the requested instrument in the device list.

The message "Connecting ..." is displayed.

Authenticate

When establishing the connection for the first time, the operating tool and the sensor must authenticate each other. After the first correct authentication, each subsequent connection is made without a new authentication query.

Enter PIN

When starting Bluetooth communication, an authentication is carried out between sensor and adjustment device by means of the sensor PIN. The sensor PIN must be entered in the adjustment device (smartphone/tablet). To increase adjustment convenience, this PIN is stored in the adjustment device. This process is secured via an algorithm acc. to standard SHA 256.

For authentication, enter in the next menu window the 4-digit PIN.

The sensor PIN as well as the sensor data are transmitted encrypted between sensor and adjustment device according to Bluetooth standard 4.0.

For the very first connection, the adjustment unit and the sensor must authenticate each other.

PIN | OK

For this purpose, enter the 4-digit PIN ("0000" is not permitted) which is used to lock or release the sensor adjustment.



Note:

If an incorrect sensor PIN is entered, the PIN can only be entered again after a delay time. This time gets longer after each incorrect entry.

The message "Waiting for authentication" is displayed on the smartphone/tablet.

Connected

After connection, the sensor adjustment menu is displayed on the respective adjustment instrument.

If the Bluetooth connection is interrupted, e.g. due to a too large distance between the two devices, this is displayed on the operating device. The message disappears when the connection is restored.

Enter parameters

7.3 Sensor parameter adjustment

The sensor adjustment menu is divided into two halves:

On the left you'll find the navigation section with the menus "Setup", "Display", "Diagnosis" and others.

The selected menu item, recognisable by the colour change, is displayed in the right half.

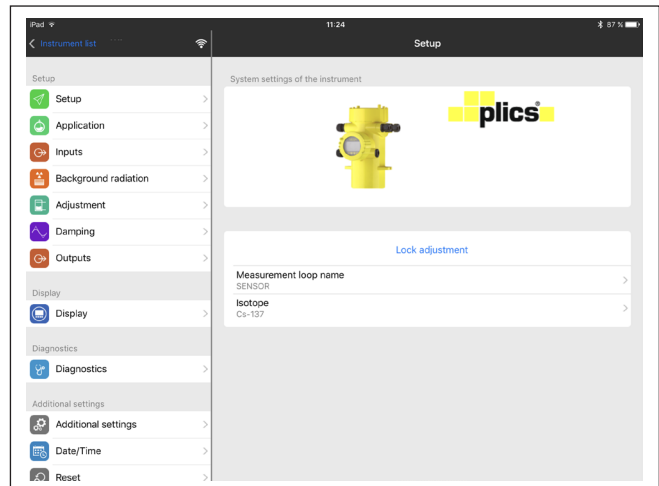

Fig. 21: Example of an app view - Setup measured values

Enter the requested parameters and confirm via the keyboard or the editing field. The settings are then active in the sensor.

Close the app to terminate connection.

8 Setup with PACTware

8.1 Connect the PC

Via the interface adapter directly on the sensor

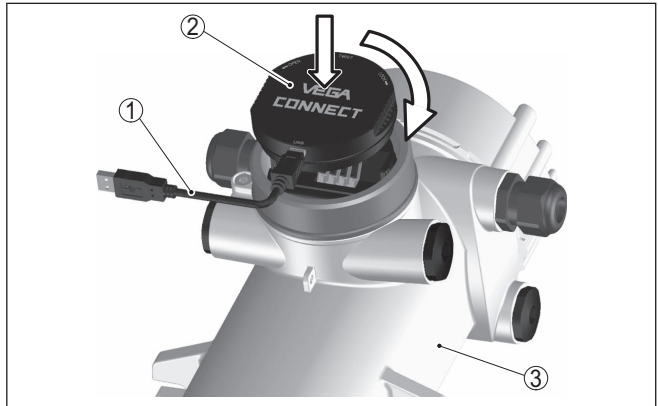

Fig. 22: Connection of the PC directly to the sensor via the interface adapter

- 1 USB cable to the PC
- 2 Interface adapter VEGACONNECT 4
- 3 Sensor



Information:

The interface adapter VEGACONNECT 3 is not suitable for connection to the sensor.

Connection via HART

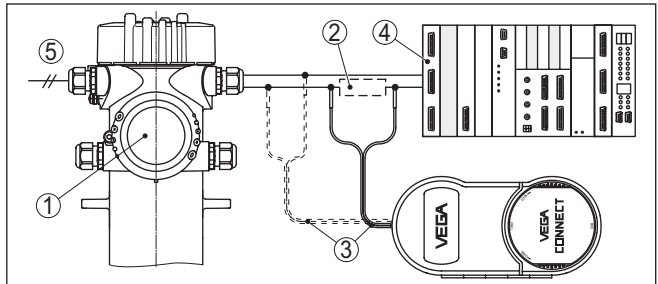

Fig. 23: Connecting the PC via HART to the signal cable

- 1 FIBERTRAC 32
- 2 HART resistance 250 Ω (optional depending on evaluation)
- 3 Connection cable with 2 mm pins and terminals
- 4 Processing system/PLC/Voltage supply
- 5 Voltage supply

Necessary components:

- FIBERTRAC 32
- PC with PACTware and suitable VEGA DTM
- VEGACONNECT 4
- HART resistance approx. 250 Ω

- Voltage supply

**Note:**

With power supply units with integrated HART resistance (internal resistance approx. 250 Ω), an additional external resistance is not necessary. This applies, e.g. to the VEGA instruments VEGATRENN 149A, VEGAMET 381 and VEGAMET 391). Commercially available Ex separators are also usually equipped with sufficient current limitation resistance. In such cases, VEGACONNECT 4 can be connected parallel to the 4 ... 20 mA cable.

8.2 Parameter adjustment with PACTware

Prerequisites

For parameter adjustment of the sensor via a Windows PC, the configuration software PACTware and a suitable instrument driver (DTM) according to FDT standard are required. The up-to-date PACTware version as well as all available DTMs are compiled in a DTM Collection. The DTMs can also be integrated into other frame applications according to FDT standard.

**Note:**

To ensure that all instrument functions are supported, you should always use the latest DTM Collection. Furthermore, not all described functions are included in older firmware versions. You can download the latest instrument software from our homepage. A description of the update procedure is also available in the Internet.

Further setup steps are described in the operating instructions manual "*DTM Collection/PACTware*" attached to each DTM Collection and which can also be downloaded from the Internet. Detailed descriptions are available in the online help of PACTware and the DTMs.

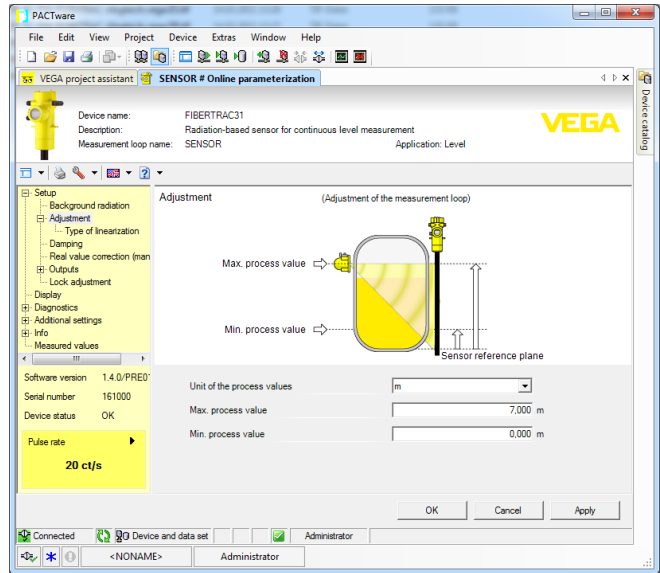

Fig. 24: Example of a DTM view

Standard/Full version

All device DTMs are available as a free-of-charge standard version and as a full version that must be purchased. In the standard version, all functions for complete setup are already included. An assistant for simple project configuration simplifies the adjustment considerably. Saving/printing the project as well as import/export functions are also part of the standard version.

In the full version there is also an extended print function for complete project documentation as well as a save function for measured value and echo curves. In addition, there is a tank calculation program as well as a multiviewer for display and analysis of the saved measured value and echo curves.

The standard version is available as a download under www.vega.com/downloads and "Software". The full version is available on CD from the agency serving you.

8.3 Saving the parameterisation data

We recommend documenting or saving the parameterisation data via PACTware. That way the data are available for multiple use or service purposes.

9 Setup with PC/notebook (Bluetooth)

9.1 Preparations

System requirements

Make sure that your PC/notebook meets the following system requirements:

- Operating system Windows 10
- DTM Collection 10/2020 or newer
- Bluetooth 4.0 LE or newer

Activate Bluetooth connection

Activate the Bluetooth connection via the project assistant.



Note:

Older systems do not always have an integrated Bluetooth LE. In these cases, a Bluetooth USB adapter is required. Activate the Bluetooth USB adapter using the Project Wizard.

After activating the integrated Bluetooth or the Bluetooth USB adapter, devices with Bluetooth are found and created in the project tree.

9.2 Connecting

Connecting

Select the requested device for the online parameter adjustment in the project tree.

Authenticate

When establishing the connection for the first time, the operating tool and the device must authenticate each other. After the first correct authentication, each subsequent connection is made without a new authentication query.

Enter PIN

For authentication, enter in the next menu window the 4-digit PIN. You can find this PIN on:

- Type label support on sensor cable
- A supplementary sheet in the sensor packaging

For the very first connection, the adjustment unit and the sensor must authenticate each other.

PIN OK

For this purpose, enter the 4-digit PIN ("0000" is not permitted) which is used to lock or release the sensor adjustment.



Note:

If an incorrect sensor PIN is entered, the PIN can only be entered again after a delay time. This time gets longer after each incorrect entry.

Connected

After connection, the sensor DTM appears.

If the connection is interrupted, e.g. due to a too large distance between device and operating device, this is displayed on the operating device. The message disappears when the connection is restored.

Change sensor PIN

It is recommended to change the default setting of the sensor PIN to your own sensor PIN. To do this, go to the menu " *Additional adjustments*", menu item " *PIN*".

9.3 Parameter adjustment

Prerequisites

For parameter adjustment of the instrument via a Windows PC, the configuration software PACTware and a suitable instrument driver (DTM) according to FDT standard are required. The latest PACTware version as well as all available DTMs are compiled in a DTM Collection. The DTMs can also be integrated into other frame applications according to FDT standard.

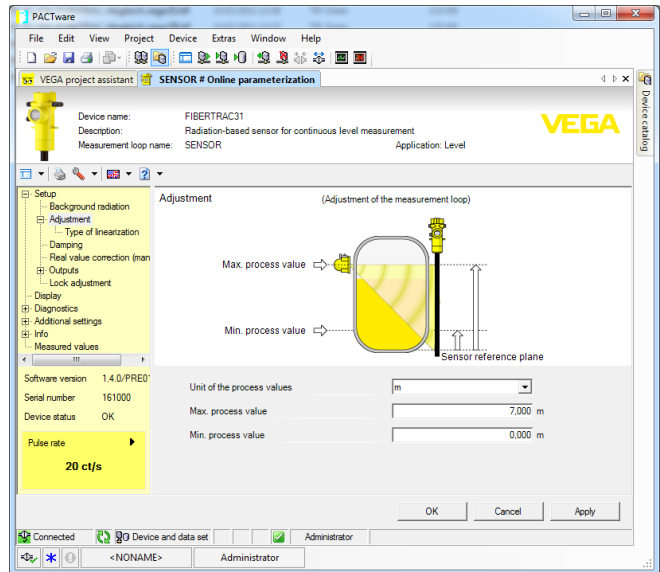

Fig. 25: Example of a DTM view

10 Set up with other systems

10.1 DD adjustment programs

Device descriptions as Enhanced Device Description (EDD) are available for DD adjustment programs such as, for example, AMS™ and PDM.

The files can be downloaded at www.vega.com/downloads under "*Software*".

10.2 Field Communicator 375, 475

Device descriptions for the instrument are available as EDD for parameterisation with Field Communicator 375 or 475.

Integrating the EDD into the Field Communicator 375 or 475 requires the "Easy Upgrade Utility" software, which is available from the manufacturer. This software is updated via the Internet and new EDDs are automatically accepted into the device catalogue of this software after they are released by the manufacturer. They can then be transferred to a Field Communicator.

11 Diagnostics and servicing

11.1 Maintenance

If the device is used properly, no special maintenance is required in normal operation.

The corresponding source container must be checked in regular intervals. You can find further information in the operating instructions manual of the source container.

11.2 Status messages

The instrument features self-monitoring and diagnostics according to NE 107 and VDI/VDE 2650. In addition to the status messages in the following tables there are more detailed error messages available under the menu item "*Diagnostics*" via the respective adjustment module.

Status messages

The status messages are divided into the following categories:

- Failure
- Function check
- Out of specification
- Maintenance required

and explained by pictographs:

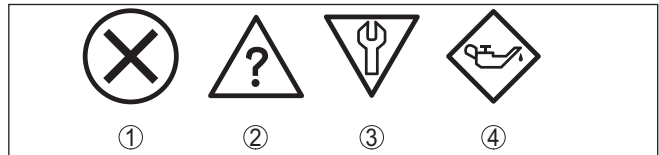

Fig. 26: Pictographs of the status messages

- 1 Failure - red
- 2 Out of specification - yellow
- 3 Function check - orange
- 4 Maintenance required - blue

Failure: Due to a malfunction in the instrument, a fault message is output.

This status message is always active. It cannot be deactivated by the user.

Function check: The instrument is being worked on, the measured value is temporarily invalid (for example during simulation).

This status message is inactive by default.

Out of specification: The measured value is unreliable because an instrument specification was exceeded (e.g. electronics temperature).

This status message is inactive by default.

Maintenance required: Due to external influences, the instrument function is limited. The measurement is affected, but the measured value is still valid. Plan in maintenance for the instrument because a failure is expected in the near future (e.g. due to buildup).

This status message is inactive by default.

Failure

Code Text message	Cause	Rectification
F008 Error multi sensor communication	Additional sensors not switched on EMC influences No other sensor available	Check wiring between the sensors Connect the sensors correctly and make them ready for operation
F013 Sensor signals a fault	Error on the current input/digital input No valid measured value Connected instruments without function	Check current input Check connected instruments (Secondary instrument)
F016 Adjustment data exchanged	Values of the min. and max. adjustment exchanged	Correct adjustment data
F017 Adjustment span too small	The values of the min. and max. adjustment are too close together	Correct adjustment data
F025 Invalid linearization table	Wrong or empty linearization table (1074, 1075, 1080, 1100, 1106) Wrong value in the linearization table (1143, 1144)	Create linearization table Correct linearization table
F030 Process value out of limits	Process values are not within the adjusted measuring range	Repeat adjustment
F034 EPROM hardware error	Electronics defective	Restart instrument Exchanging the electronics
F035 EPROM data error	Error in the internal instrument communication	Carry out a reset Exchanging the electronics
F036 Faulty program memory	Error during software update	Repeat software update Exchanging the electronics
F037 RAM hardware error	Error in RAM	Restart instrument Exchanging the electronics
F038 Secondary signals failure	Connection cable to the Secondary instrument interrupted Instrument not defined as Secondary instrument One of the Secondary instruments signals a failure	Check the connection cable to the Secondary instrument Define instrument as Secondary Check Secondary instruments
F040 Hardware error	Instrument defective (1092, 1126) Temperature outside the specification (1091)	Restart instrument Exchanging the electronics Cool the instrument or protect it with isolation material against heat/cold
F041 Photomultiplier error	Error in the measured value recording	Restart instrument Exchanging the electronics
F045 Error on the current output	Error on the current output	Check wiring of the current output Exchanging the electronics

Code Text message	Cause	Rectification
F052 Faulty configuration	Invalid parameter adjustment	Carry out a reset
F066 Faulty adjustment	Adjustment not yet carried out Error during adjustment or when entering the linearisation table	Carry out adjustment Carry out linearisation
F068 Count rate too high	Faulty instrument settings (1031) Faulty steam density compensation (1101)	Carry out a reset Check Secondary instrument (steam density)
F072 Limit exceeded	Faulty instrument settings	Carry out a reset
F073 Error real value correction	Faulty real value correction	Carry out real value correction again
F080 System error	Instrument error	Restart instrument Call our service
F086 Communication error	Error in the Fieldbus communication	Restart instrument Call our service
F114 Error real time clock	Discharge accumulator	Readjust real time clock
F120 Filter time error	Faulty or missing instrument adjustment	Carry out adjustment
F121 Faulty participant list on the multisensor communication bus	Secondary instruments not found Secondary instrument with wrong address	Check Secondary instruments Check Secondary list in Primary instrument Correct address of Secondary instruments
F122 Double addresses on the multisensor communication bus	Instrument address was assigned several times	Change instrument addresses
F123 X-ray alarm	External instruments cause radiation Radiation above the max. adjustment value	Determine reason for X-ray alarm In case of brief X-ray radiation: Monitor switching outputs for this time manually
F124 Alarm due to increased radiation	Radiation dose too high	Determine reason for increased radiation
F125 Ambient temperature too high	Ambient temperature on the housing outside the specification	Cool the instrument or protect it with isolating material against radiation heat
F126 Error in the trend recording	Instrument error	Call our service

Code Text message	Cause	Rectification
F141 Communication error on the multisensor communication bus	Secondary instrument does not answer	Check Secondary instruments

Tab. 4: Error codes and text messages, information on causes as well as corrective measures

Function check

Code Text message	Cause	Rectification
C029 Simulation	Simulation active	Finish simulation Wait for the automatic end after 60 mins.

Tab. 5: Error codes and text messages, information on causes as well as corrective measures

Out of specification

Code Text message	Cause	Rectification
S017 Accuracy outside the specification	Accuracy outside the specification	Correct adjustment data
S025 Bad linearization table	Bad linearization table	Carry out linearisation
S038 Secondary outside the specification	Secondary instrument outside the specification	Check Secondary instruments
S125 Ambient temperature too high/too low	Ambient temperature too high/too low	Protect instrument with isolating material against extreme temperatures

Tab. 6: Error codes and text messages, information on causes as well as corrective measures

Maintenance

The instrument has no status messages to the section "Maintenance".

11.3 Rectify faults

Reaction when malfunction occurs

The operator of the system is responsible for taking suitable measures to rectify faults.

Fault rectification

The first measures are:

- Evaluation of fault messages
- Checking the output signal
- Treatment of measurement errors

A smartphone/tablet with the adjustment app or a PC/notebook with the software PACTware and the suitable DTM offer you further comprehensive diagnostic possibilities. In many cases, the causes can be determined in this way and the faults eliminated.

Check 4 ... 20 mA signal (level measurement)

Connect a multimeter in the suitable measuring range according to the wiring plan. The following table describes possible errors in the current signal and helps to eliminate them:

Error	Cause	Rectification
4 ... 20 mA signal not stable	Level fluctuations	Set damping appropriate to the instrument via the display and adjustment module or PACT-ware/DTM
4 ... 20 mA signal missing	Electrical connection faulty	Check connection according to chapter "Connection steps" and if necessary, correct according to chapter "Wiring plan"
	Voltage supply missing	Check cables for breaks; repair if necessary
	Operating voltage too low or load resistance too high	Check, adapt if necessary
Current signal greater than 22 mA or less than 3.6 mA	Instrument on failure message	Note error message on the display and adjustment module

Check output signal (level detection)

The following table describes possible faults that may not generate an error message:

Error	Cause	Rectification
The instrument signals covered without being covered by the measured medium The instrument signals uncovered while covered with the measured medium	Voltage supply missing	Check cables for breaks; repair if necessary
	Operating voltage too low or load resistance too high	Check, adapt if necessary
	Electrical connection faulty	Check connection according to chapter "Connection steps" and if necessary, correct according to chapter "Wiring plan"
	Electronics defective	Change the switching behaviour of the sensors under "Diagnosis/Simulation". If the instrument does not switch over, send it in for repair.
	Buildup on the inner wall of the vessel	Remove buildup Check the Delta I value. Improve the switching threshold - carry out a double point adjustment
Current signal greater than 22 mA or less than 3.6 mA	Electronics module in the sensor defective	Note error messages on the display and adjustment module

Reaction after fault rectification

Depending on the reason for the fault and the measures taken, the steps described in chapter "Setup" must be carried out again or must be checked for plausibility and completeness.

24 hour service hotline

Should these measures not be successful, please call in urgent cases the VEGA service hotline under the phone no. **+49 1805 858550**.

The hotline is also available outside normal working hours, seven days a week around the clock.

Since we offer this service worldwide, the support is provided in English. The service itself is free of charge, the only costs involved are the normal call charges.

11.4 Exchanging the electronics module

If the electronics module is defective, it can be replaced by the user.



Note:

For sensors with the application-specific settings "Self-radiating medium (NORM compensation)" or "Redundant measurement (NORM compensation)", the electronics module cannot be exchanged on site. The electronics of the instrument can only be exchanged in the factory.

Contact our sales staff.



In Ex applications, only instruments and electronics modules with appropriate Ex approval may be used.

If there is no electronics module available on site, the electronics module can be ordered through the agency serving you. The electronics modules are adapted to the respective sensor and differ in signal output or voltage supply.

The new electronics module must be loaded with the default settings of the sensor. These are the options:

- In the factory
- Or on site by the user

In both cases, the serial number of the sensor is needed. The serial numbers are stated on the type label of the instrument, on the inside of the housing as well as on the delivery note.

When loading on site, the order data must first be downloaded from the Internet (see operating instructions "*Electronics module*").



Caution:

All application-specific settings must be entered again. That's why you have to carry out a fresh setup after exchanging the electronics.

If you saved the parameter settings during the first setup of the sensor, you can transfer them to the replacement electronics module. A fresh setup is then not necessary.

11.5 Software update

The following components are required to update the instrument software:

- Instrument
- Voltage supply
- Interface adapter VEGACONNECT
- PC with PACTware
- Current instrument software as file

You can find the current instrument software as well as detailed information on the procedure in the download area of our homepage: www.vega.com.

You can find information about the installation in the download file.

**Caution:**

Instruments with approvals can be bound to certain software versions. Therefore make sure that the approval is still effective after a software update is carried out.

You can find detailed information in the download area at www.vega.com.

11.6 How to proceed if a repair is necessary

The following procedure refers only to the sensor. Should a repair of the source container be necessary, you can find the respective instructions in the operating instructions manual of the source container.

You can find an instrument return form as well as detailed information about the procedure in the download area of our homepage: www.vega.com

By doing this you help us carry out the repair quickly and without having to call back for needed information.

If a repair is necessary, please proceed as follows:

- Print and fill out one form per instrument
- Clean the instrument and pack it damage-proof
- Attach the completed form and, if need be, also a safety data sheet outside on the packaging
- Please contact the agency serving you to get the address for the return shipment. You can find the agency on our home page www.vega.com.

12 Dismount

12.1 Dismounting steps

**Warning:**

Before dismantling, be aware of dangerous process conditions such as e.g. pressure in the vessel or pipeline, high temperatures, corrosive or toxic media etc.

Take note of chapters "*Mounting*" and "*Connecting to voltage supply*" and carry out the listed steps in reverse order.

12.2 Disposal

The instrument consists of materials which can be recycled by specialised recycling companies. We use recyclable materials and have designed the electronics to be easily separable.

WEEE directive

The instrument does not fall in the scope of the EU WEEE directive. Article 2 of this Directive exempts electrical and electronic equipment from this requirement if it is part of another instrument that does not fall in the scope of the Directive. These include stationary industrial plants.

Pass the instrument directly on to a specialised recycling company and do not use the municipal collecting points.

If you have no way to dispose of the old instrument properly, please contact us concerning return and disposal.

13 Supplement

13.1 Technical data

Note for approved instruments

The technical data in the respective safety instructions which are included in delivery are valid for approved instruments (e.g. with Ex approval). These data can differ from the data listed herein, for example regarding the process conditions or the voltage supply.

All approval documents can be downloaded from our homepage.

General data

316L corresponds to 1.4404 or 1.4435

Materials, non-wetted parts

- | | |
|---|---|
| - Detector hose | Galvanized steel with Santoprene rubber coating |
| - Scintillation material | PS (Polystyrene) |
| - Aluminium die-cast housing | Aluminium die-casting AlSi10Mg, powder-coated (Basis: Polyester) |
| - Stainless steel housing | 316L |
| - Seal between housing and housing lid | NBR (stainless steel housing, investment casting), silicone (Aluminium housing) |
| - Inspection window in housing cover (optional) | Polycarbonate |
| - Ground terminal | 316L |
| - Cable gland | PA, stainless steel, brass |
| - Sealing, cable gland | NBR |
| - Blind plug, cable gland | PA |
| - Mounting accessories | 316L |

Process fittings

- | | |
|------------------|---|
| - Fastening lugs | ø 9 mm (0.35 in), hole centre distance 119 mm (4.69 in) |
|------------------|---|

Weight

- | | |
|---|----------------------------------|
| - Aluminium housing, with electronics | 5.9 kg (13 lbs) + Detector hose |
| - Stainless steel housing, with electronics | 10.9 kg (24 lbs) + Detector hose |
| - Detector hose | 2.31 kg/m (1.55 lbs/ft) |

Max. torque, mounting screws

- | | |
|--|--|
| - Fastening lugs in the sensor housing | 15 Nm (11.1 lbf ft), stainless steel A4-70 |
|--|--|

Max. torque for NPT cable glands and Conduit tubes

- | | |
|-------------------------------------|----------------------|
| - Aluminium/Stainless steel housing | 50 Nm (36.88 lbf ft) |
|-------------------------------------|----------------------|

Input variable

Measured variable	The measured variable is the intensity of the gamma radiation of an isotope. When the radiation intensity decreases, for example due to rising medium, the measured value of FIBERTRAC 32 changes in proportion to the level.
-------------------	---

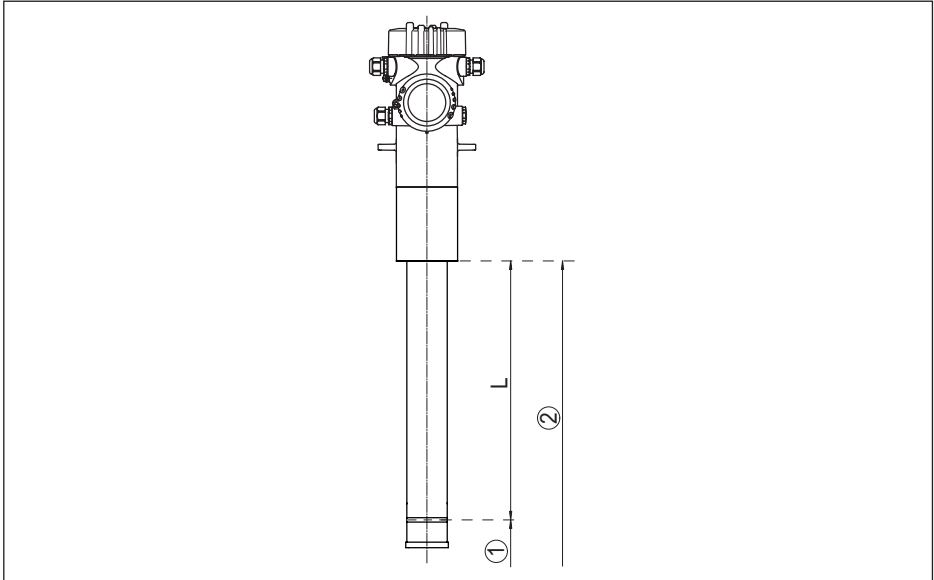

Fig. 27: Data of the input variable

- 1 Min. level (red marking line)
 2 Max. level
 L Measuring range (order length of instruments)

Measuring range (L) 1000 ... 7000 mm (3.28 ... 22.97 ft)

Analogue input

- Input type 4 ... 20 mA, passive
- Internal load 250 Ω

Switching input

- Type of input - Open Collector 10 mA
- Type of input - Relay contact 100 mA

Output variable - Level measurement

Output signals	4 ... 20 mA/HART - active; 4 ... 20 mA/HART - passive
Range of the output signal	3.8 ... 20.5 mA/HART
Terminal voltage passive	9 ... 30 V DC
Shortcircuit protection	Available
Potential separation	Available
Signal resolution	0.3 μ A
Fault signal, current output (adjustable)	22 mA, < 3.6 mA
Max. output current	22 mA
Starting current	\leq 3.6 mA
Load	
- 4 ... 20 mA/HART - active	< 500 Ω

- 4 ... 20 mA/HART - intrinsically safe	< 300 Ω
Damping (63 % of the input variable)	1 ... 1200 s, adjustable
HART output values	
- PV (Primary Value)	Level
- SV (Secondary Value)	Electronics temperature
- TV (Third Value)	Output value freely selectable, e.g. pulse rate
- QV (Quaternary Value)	Output value freely selectable, e.g. pulse rate
Fulfilled HART specification	7.0
Further information on Manufacturer ID, Device ID, Device Revision	See website of HART Communication Foundation

Output variable - Level detection

Output signals	8/16 mA
Terminal voltage passive	9 ... 30 V DC
Shortcircuit protection	Available
Potential separation	Available
Fault signal, current output (adjustable)	22 mA, < 3.6 mA
Max. output current	22 mA
Starting current	≤ 3.6 mA
Load	
- 4 ... 20 mA/HART - active	< 500 Ω
- 4 ... 20 mA/HART - intrinsically safe	< 300 Ω
Damping (63 % of the input variable)	Automatically
HART output values	
- PV (Primary Value)	Switching status
- SV (Secondary Value)	Electronics temperature
- TV (Third Value)	Output value freely selectable, e.g. pulse rate
- QV (Quaternary Value)	Output value freely selectable, e.g. pulse rate
Fulfilled HART specification	7.0
Further information on Manufacturer ID, Device ID, Device Revision	See website of HART Communication Foundation

Relay output

Output	Relay output (SPDT), floating spdt
Switching voltage	max. 253 V AC/DC With circuits > 150 V AC/DC, the relay contacts must be in the same circuit.
Switching current	max. 3 A AC (cos phi > 0.9), 1 A DC
Breaking capacity	
- Min.	50 mW

- Max.	750 VA AC, 40 W DC (at U < 40 V DC) If inductive loads or stronger currents are switched through, the gold plating on the relay contact surface will be permanently damaged. The contact is then no longer suitable for switching low-level signal circuits.
Contact material (relay contacts)	AgNi or AgSnO ₂ each with 3 µm gold plating

Transistor output

Output	Floating transistor output, permanently shortcircuit-proof
Load current	< 400 mA
Voltage loss	< 1 V
Switching voltage	< 55 V DC
Blocking current	< 10 µA

Measurement accuracy (according to DIN EN 60770-1)

Process reference conditions according to DIN EN 61298-1

- Temperature	+18 ... +30 °C (+64 ... +86 °F)
- Relative humidity	45 ... 75 %
- Air pressure	860 ... 1060 mbar/86 ... 106 kPa (12.5 ... 15.4 psig)
Non-repeatability	≤ 0.5 %
Deviation with bulk solids	The values depend to a great extent on the application. Binding specifications are thus not possible.
Deviation under EMC influence	≤ 1 %

Variables influencing measurement accuracy

Specifications apply also to the current output

Temperature drift - Current output	±0.03 %/10 K relating to the 16 mA span or max. ±0.3 %
Deviation in the current output due to analogue/digital conversion	<±15 µA
Deviation on the current output due to strong, high frequency electromagnetic interference acc. to EN 61326	<±150 µA

Characteristics and performance data

Step response time ⁶⁾	≤ 5 s (with damping 1 s)
----------------------------------	--------------------------

Ambient conditions

Storage and transport temperature	-40 ... +60 °C (-40 ... +140 °F)
-----------------------------------	----------------------------------

Process conditions

For the process conditions, please also note the specifications on the type label. The lower value always applies.

Process pressure	Unpressurized
------------------	---------------

⁶⁾ Time span after a sudden measuring distance change by max. 0.5 m in liquid applications, max 2 m with bulk solids applications, until the output signal has taken for the first time 90 % of the final value (IEC 61298-2).

Ambient temperature (measured on the detector hose)	-20 ... +50 °C (-4 ... +122 °F) With temperatures higher than 50 °C we recommend the use of water cooling
Vibration resistance ⁷⁾	mechanical vibrations up to 1 g in the frequency range 5 ... 200 Hz

Electromechanical data - version IP66/IP67

Options of the cable entry

- Cable entry	M20 x 1.5; ½ NPT
- Cable gland	M20 x 1.5; ½ NPT (cable diameter see below table)
- Blind plug	M20 x 1.5; ½ NPT
- Closing cap	½ NPT

Material cable gland	Material seal insert	Cable diameter				
		4.5 ... 8.5 mm	5 ... 9 mm	6 ... 12 mm	7 ... 12 mm	10 ... 14 mm
PA	NBR	-	●	●	-	●
Brass, nickel-plated	NBR	●	●	●	-	-
Stainless steel	NBR	-	●	●	-	●

Wire cross-section (spring-loaded terminals)

- Massive wire, stranded wire	0.2 ... 2.5 mm ² (AWG 24 ... 14)
- Stranded wire with end sleeve	0.2 ... 1.5 mm ² (AWG 24 ... 16)

Integrated clock

Date format	Day.Month.Year
Time format	12 h/24 h
Time zone, factory setting	CET
Max. rate deviation	10.5 min/year

Additional output parameter - Electronics temperature

Output of the temperature values

- Analogue	Via the current output
- Digital	Via the digital output signal (depending on the electronics version)
Range	-40 ... +50 °C (-40 ... +122 °F)
Resolution	< 0.1 K
Accuracy	±5 K

Voltage supply

Operating voltage	20 ... 72 V DC or 20 ... 253 V AC, 50/60 Hz
Reverse voltage protection	Available

⁷⁾ Tested according to the guidelines of German Lloyd, GL directive 2.

Max. power consumption	6 VA (AC); 4 W (DC)
------------------------	---------------------

Electrical protective measures

Protection, depending on housing version	IP66/IP67 (NEMA Type 4X) ⁸⁾
Overvoltage category	The feeding power supply unit can be connected to networks of overvoltage category III.
Protection class	I

13.2 Dimensions

The following dimensional drawings represent only an extract of all possible versions. Detailed dimensional drawings can be downloaded at www.vega.com/downloads under "*Drawings*".

⁸⁾ A suitable cable is required for maintaining the protection rating.

Aluminium and stainless steel housing

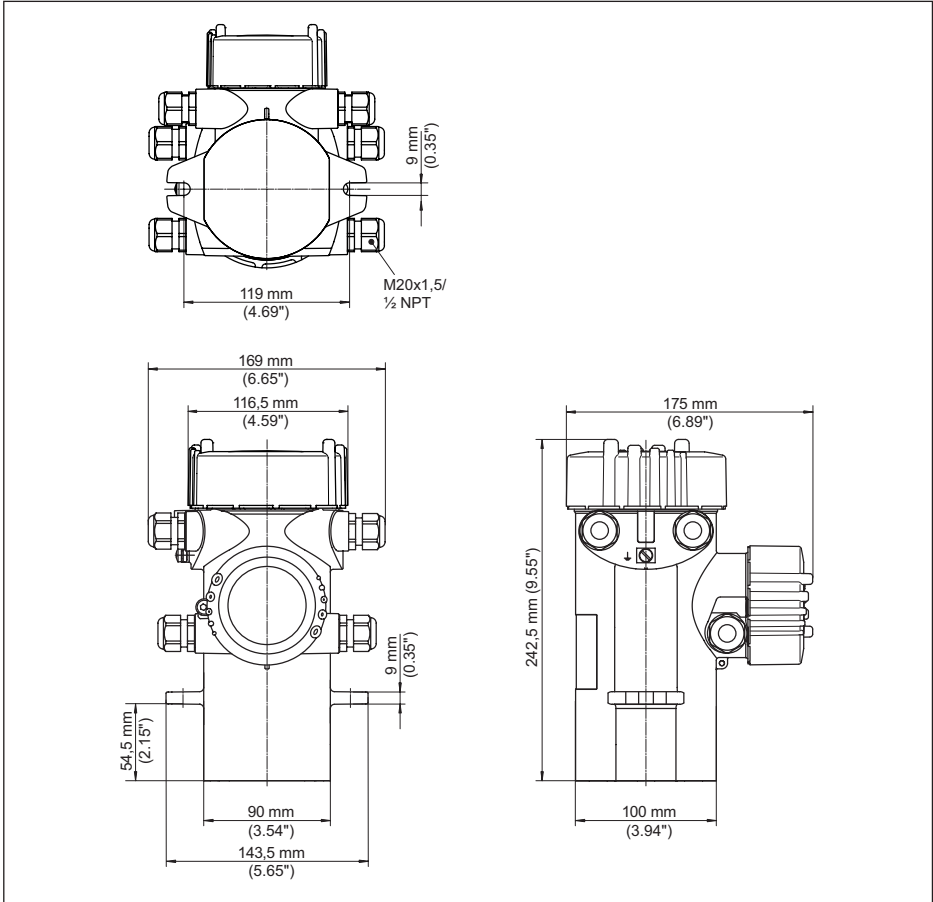

Fig. 28: Aluminium housing or stainless steel housing (precision casting)

FIBERTRAC 32

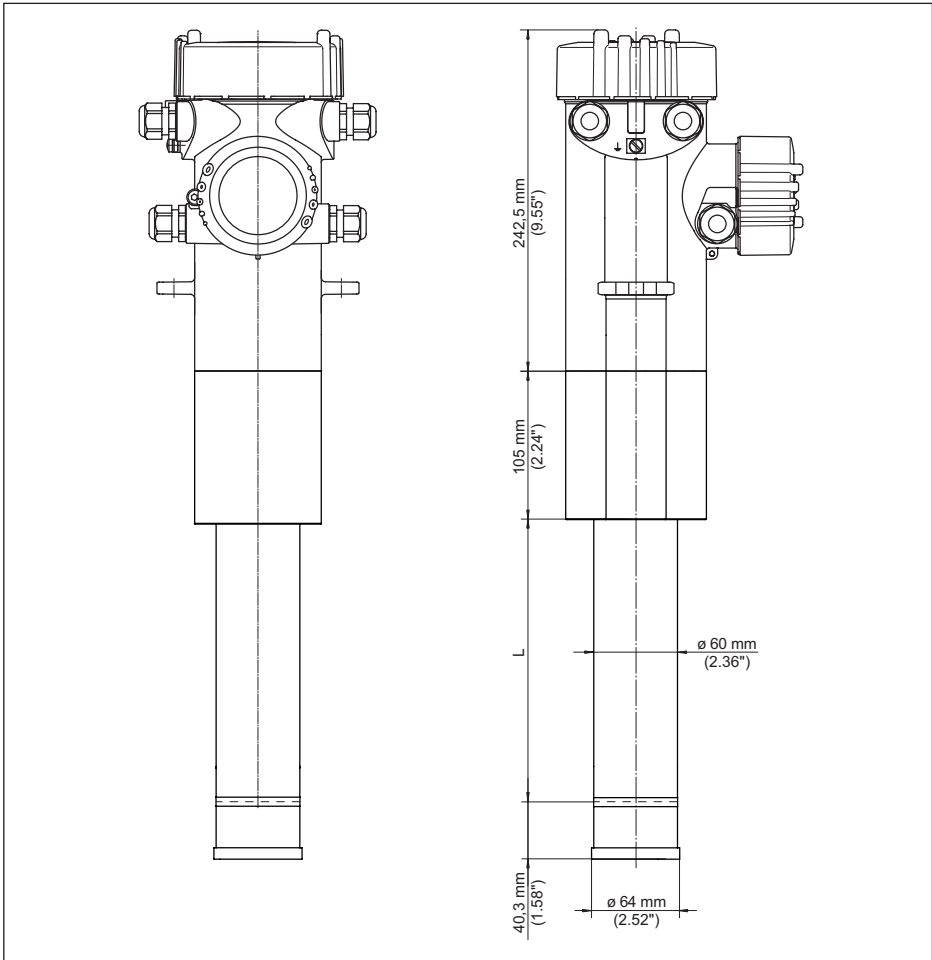

Fig. 29: FIBERTRAC 32

L Measuring range (order length of instruments)

FIBERTRAC 32 - Mounting example

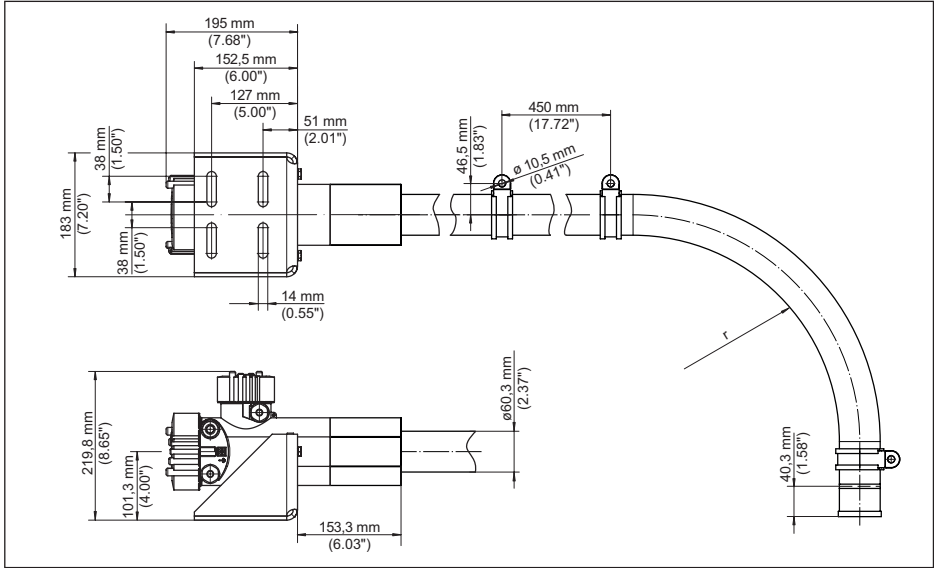

Fig. 30: FIBERTRAC 32 with supplied mounting accessories

r Min. bending radius: 305 mm (12 in)

13.3 Industrial property rights

VEGA product lines are global protected by industrial property rights. Further information see www.vega.com.

VEGA Produktfamilien sind weltweit geschützt durch gewerbliche Schutzrechte.

Nähere Informationen unter www.vega.com.

Les lignes de produits VEGA sont globalement protégées par des droits de propriété intellectuelle. Pour plus d'informations, on pourra se référer au site www.vega.com.

VEGA líneas de productos están protegidas por los derechos en el campo de la propiedad industrial. Para mayor información revise la pagina web www.vega.com.

Линии продукции фирмы ВЕГА защищаются по всему миру правами на интеллектуальную собственность. Дальнейшую информацию смотрите на сайте www.vega.com.

VEGA系列产品在全球享有知识产权保护。

进一步信息请参见网站 < www.vega.com。

13.4 Trademark

All the brands as well as trade and company names used are property of their lawful proprietor/originator.

INDEX

A

- Accessories 10, 11
 - Display and adjustment module 9
 - External display and adjustment unit 9
 - External indicating unit 9
 - Gamma modulator 10
- Adjustment 31
 - System 28
- Adjustment data 37, 52
- Adjustment mode 48
- Adjustment point 48
- Application 31, 43, 47

B

- Background radiation 31, 47

C

- Cable entry 14, 18
- Cable gland 14, 18
- Cascading 42
- Check signal 69
- Connection cable 18
- Connection procedure 19
- Connection technology 19
- Control areas 12
- Cooling 10
- Current output, min./max. 35
- Current output mode 35, 50

D

- Damping 34, 53
- Date 38, 53
- Date of manufacture 41, 56
- Default values 39, 45, 54
- Delta I 49
- Device DTMs 60
- Device name 41, 56
- Device settings Copy 41, 55
- Displayed value 37, 52

E

- EDD (Enhanced Device Description) 64

F

- Fault
 - Rectification 68
- Fault rectification 68
- Functional principle 8

G

- Gamma modulator 10
- Grounding 19

H

- Handling permit 12
- HART 40, 55
- Heat 17

I

- Installation position 14
- Instrument features 41, 56
- Instrument return form 71
- Instrument version 41, 56
- Isotope
 - Co-60 30, 47
 - Cs-137 30, 47

L

- Language 37, 52
- Linearisation 32
- Lock adjustment 36, 44, 51

M

- Main menu 29, 42, 46
- Measurement loop name 30, 43, 46
- Mode 40, 55

N

- NAMUR NE 107 65
 - Failure 66
 - Function check 68
 - Maintenance 68
 - Out of specification 68

O

- Outputs 43

P

- PACTware 60
- Peak value indicator 37, 52
- Potential equalisation 19
- Protection class 18

R

- Radiation protection 12
- Radiation safety officer 12
- Real value correction 34
- Relay 35, 51
- Repair 71

Replacement parts
– Electronics module 9
Reset 39, 44, 54

S

Sensor status 37, 52
Service hotline 69
Shielding 19
Shielding, radiometric 11
Simulation 38, 53
Source 30, 47
Source holder 11
Summation Secondary 42

T

Time 38, 53
Type label 7

U

Unit 48
Units 31

V

Voltage supply 18, 77

W

Water cooling 17

X

X-ray alarm 35

A large grid of graph paper for taking notes, consisting of 20 columns and 30 rows of small squares.





Printing date:

VEGA

All statements concerning scope of delivery, application, practical use and operating conditions of the sensors and processing systems correspond to the information available at the time of printing.

Subject to change without prior notice

© VEGA Grieshaber KG, Schiltach/Germany 2021



37428-EN-210311

VEGA Grieshaber KG
Am Hohenstein 113
77761 Schiltach
Germany

Phone +49 7836 50-0
E-mail: info.de@vega.com
www.vega.com