

Operating Instructions

Double-channel controller for point level detection with conductive sensors

VEGATOR 132



Document ID: 46837



VEGA

Contents

| | | |
|-----------|--|-----------|
| 1 | About this document | 4 |
| 1.1 | Function | 4 |
| 1.2 | Target group | 4 |
| 1.3 | Symbols used | 4 |
| 2 | For your safety | 5 |
| 2.1 | Authorised personnel | 5 |
| 2.2 | Appropriate use | 5 |
| 2.3 | Warning about incorrect use | 5 |
| 2.4 | General safety instructions | 5 |
| 2.5 | Installation and operation in the USA and Canada | 5 |
| 2.6 | Safety instructions for Ex areas | 6 |
| 3 | Product description | 7 |
| 3.1 | Configuration | 7 |
| 3.2 | Principle of operation | 7 |
| 3.3 | Adjustment | 8 |
| 3.4 | Packaging, transport and storage | 8 |
| 4 | Mounting | 9 |
| 4.1 | General instructions | 9 |
| 5 | Connecting to power supply | 10 |
| 5.1 | Preparing the connection | 10 |
| 5.2 | Connection procedure | 11 |
| 5.3 | Wiring plan | 12 |
| 5.4 | Wiring plan four-channel control | 13 |
| 6 | Setup | 14 |
| 6.1 | Adjustment system | 14 |
| 6.2 | Adjustment elements | 14 |
| 6.3 | Switch point adjustment with conductive sensor | 17 |
| 6.4 | Proof test | 18 |
| 6.5 | Function table "Point level" | 19 |
| 6.6 | Function table, two-point control | 19 |
| 7 | Diagnostics and servicing | 22 |
| 7.1 | Maintenance | 22 |
| 7.2 | Rectify faults | 22 |
| 7.3 | Diagnosis, fault messages | 22 |
| 7.4 | How to proceed if a repair is necessary | 23 |
| 8 | Dismount | 24 |
| 8.1 | Dismounting steps | 24 |
| 8.2 | Disposal | 24 |
| 9 | Certificates and approvals | 25 |
| 9.1 | Approvals for Ex areas | 25 |
| 9.2 | EU conformity | 25 |
| 9.3 | Environment management system | 25 |
| 10 | Supplement | 26 |
| 10.1 | Technical data | 26 |

| | | |
|------|---------------------------------|----|
| 10.2 | Dimensions | 28 |
| 10.3 | Industrial property rights..... | 29 |
| 10.4 | Trademark | 29 |

Supplementary documentation



Information:

Supplementary documents appropriate to the ordered version come with the delivery. You can find them listed in chapter "*Product description*".

Editing status: 2021-07-12

1 About this document

1.1 Function

This instruction provides all the information you need for mounting, connection and setup as well as important instructions for maintenance, fault rectification, the exchange of parts and the safety of the user. Please read this information before putting the instrument into operation and keep this manual accessible in the immediate vicinity of the device.

1.2 Target group

This operating instructions manual is directed to trained personnel. The contents of this manual must be made available to the qualified personnel and implemented.

1.3 Symbols used



Document ID

This symbol on the front page of this instruction refers to the Document ID. By entering the Document ID on www.vega.com you will reach the document download.



Information, note, tip: This symbol indicates helpful additional information and tips for successful work.



Note: This symbol indicates notes to prevent failures, malfunctions, damage to devices or plants.



Caution: Non-observance of the information marked with this symbol may result in personal injury.



Warning: Non-observance of the information marked with this symbol may result in serious or fatal personal injury.



Danger: Non-observance of the information marked with this symbol results in serious or fatal personal injury.



Ex applications

This symbol indicates special instructions for Ex applications.



List

The dot set in front indicates a list with no implied sequence.



Sequence of actions

Numbers set in front indicate successive steps in a procedure.



Battery disposal

This symbol indicates special information about the disposal of batteries and accumulators.

2 For your safety

2.1 Authorised personnel

All operations described in this documentation must be carried out only by trained, qualified personnel authorised by the plant operator.

During work on and with the device, the required personal protective equipment must always be worn.

2.2 Appropriate use

VEGATOR 132 is a universal controller for connection of conductive sensors.

You can find detailed information about the area of application in chapter "*Product description*".

Operational reliability is ensured only if the instrument is properly used according to the specifications in the operating instructions manual as well as possible supplementary instructions.

2.3 Warning about incorrect use

Inappropriate or incorrect use of this product can give rise to application-specific hazards, e.g. vessel overfill through incorrect mounting or adjustment. Damage to property and persons or environmental contamination can result. Also, the protective characteristics of the instrument can be impaired.

2.4 General safety instructions

This is a state-of-the-art instrument complying with all prevailing regulations and directives. The instrument must only be operated in a technically flawless and reliable condition. The operator is responsible for the trouble-free operation of the instrument. When measuring aggressive or corrosive media that can cause a dangerous situation if the instrument malfunctions, the operator has to implement suitable measures to make sure the instrument is functioning properly.

The safety instructions in this operating instructions manual, the national installation standards as well as the valid safety regulations and accident prevention rules must be observed by the user.

For safety and warranty reasons, any invasive work on the device beyond that described in the operating instructions manual may be carried out only by personnel authorised by the manufacturer. Arbitrary conversions or modifications are explicitly forbidden. For safety reasons, only the accessory specified by the manufacturer must be used.

To avoid any danger, the safety approval markings and safety tips on the device must also be observed.

2.5 Installation and operation in the USA and Canada

This information is only valid for USA and Canada. Hence the following text is only available in the English language.

Installations in the US shall comply with the relevant requirements of the National Electrical Code (ANSI/NFPA 70).

Installations in Canada shall comply with the relevant requirements of the Canadian Electrical Code.

2.6 Safety instructions for Ex areas

For applications in explosion-proof areas (Ex), only devices with corresponding Ex approval may be used. Observe the Ex-specific safety instructions. These are an integral part of the operating instructions and are enclosed with every device with Ex approval.

3 Product description

3.1 Configuration

Scope of delivery

The scope of delivery encompasses:

- Controller VEGATOR 132
- Documentation
 - This operating instructions manual
 - Ex-specific "*Safety instructions*" (with Ex versions)
 - If necessary, further certificates

Type label

The type label contains the most important data for identification and use of the instrument:

- Instrument type
- Information about approvals
- Technical data
- Serial number of the instrument
- QR code for device documentation
- Manufacturer information

Documents and software

Move to "www.vega.com" and enter in the search field the serial number of your instrument.

There you can find the following information about the instrument:

- Order data
- Documentation
- Software

Alternatively, you can find all via your smartphone:

- Scan the QR-code on the type label of the device or
- Enter serial number manually in the VEGA Tools app (available free of charge in the respective stores)

3.2 Principle of operation

Application area

The VEGATOR 132 is a double-channel controller for level detection with conductive sensors of series EL. Simple monitoring and control functions can be realised via the integrated relays. Typical applications are monitoring functions such as overflow and dry run protection as well as pump controls.

Functional principle

In conductive measurement, a low voltage is applied to two electrodes. Alternatively, a single electrode can be used in metallic vessels, the earth cable must then be connected to the vessel. By using alternating voltage, electrolytic decomposition of the probe rods and the medium is avoided. When the (conductive) medium comes into contact with the electrode(s), a current flows and is detected and further processed by the controller.

The switching point of the relay can be adjusted to the respective conductivity by using the potentiometer. The output relay switches when this current is reached (in dependence on the set mode).

3.3 Adjustment

All adjustment elements are located under a hinged front cover. For example the operating mode, the switching delay and the function as Primary/Secondary Device can be set via a DIL switch block. The switching point can be adjusted via a potentiometer.

3.4 Packaging, transport and storage

Packaging

Your instrument was protected by packaging during transport. Its capacity to handle normal loads during transport is assured by a test based on ISO 4180.

The packaging of standard instruments consists of environment-friendly, recyclable cardboard. For special versions, PE foam or PE foil is also used. Dispose of the packaging material via specialised recycling companies.

Transport

Transport must be carried out in due consideration of the notes on the transport packaging. Nonobservance of these instructions can cause damage to the device.

Transport inspection

The delivery must be checked for completeness and possible transit damage immediately at receipt. Ascertained transit damage or concealed defects must be appropriately dealt with.

Storage

Up to the time of installation, the packages must be left closed and stored according to the orientation and storage markings on the outside.

Unless otherwise indicated, the packages must be stored only under the following conditions:

- Not in the open
- Dry and dust free
- Not exposed to corrosive media
- Protected against solar radiation
- Avoiding mechanical shock and vibration

Storage and transport temperature

- Storage and transport temperature see chapter " *Supplement - Technical data - Ambient conditions* "
- Relative humidity 20 ... 85 %

4 Mounting

Mounting options

4.1 General instructions

VEGATOR 132 is designed for carrier rail mounting (top hat rail 35 x 7.5 according to DIN EN 50022/60715). Due to its protection rating of IP20, the instrument is suitable for mounting in switching cabinets. It can be mounted horizontally and vertically.

**Note:**

When several instruments are mounted together without space in between, the ambient temperature at the installation location of the instrument must not exceed 60 °C. Around the ventilation slots there must be a distance of at least 2 cm to the next component.



VEGATOR 132 in Ex version is a corresponding, intrinsically safe instrument and must not be installed in hazardous areas. A safe operation is only ensured if the operating instructions and EU type approval certificate are observed. VEGATOR 132 must not be opened.

A distance of 50 mm to the intrinsically safe terminals must be ensured when mounting.

Ambient conditions

The instrument is suitable for standard and extended ambient conditions acc. to DIN/EN/IEC/ANSI/ISA/UL/CSA 61010-1.

Make sure that the environmental and ambient conditions specified in chapter " *Technical data*" are maintained.

5 Connecting to power supply

5.1 Preparing the connection

Safety instructions

Always keep in mind the following safety instructions:



Warning:

Connect only in the complete absence of line voltage.

- Connect only in the complete absence of line voltage
- If overvoltage surges are expected, overvoltage arresters should be installed



Note:

Install a disconnecting device for the instrument which is easy to access. The disconnecting device must be marked for the instrument (IEC/EN 61010).

Safety instructions for Ex applications



In hazardous areas you must take note of the respective regulations, conformity and type approval certificates of the sensors and power supply units.

Voltage supply

The data for power supply are specified in chapter " *Technical data*".

Connection cable

The voltage supply of VEGATOR 132 is connected with standard cable according to the national installation standards.

The sensors are connected with standard two-wire cable without shielding. If electromagnetic interference is expected which is above the test values of EN 61326 for industrial areas, shielded cable should be used.

Make sure that the cable used has the required temperature resistance and fire safety for max. occurring ambient temperature

Cable screening and grounding

Connect the cable shielding on both ends to ground potential. In the sensor, the shielding must be connected directly to the internal ground terminal. The ground terminal on the outside of the sensor housing must be connected to the potential equalisation (low impedance).

If potential equalisation currents are expected, the connection on the processing side must be made via a ceramic capacitor (e. g. 1 nF, 1500 V). The low-frequency potential equalisation currents are thus suppressed, but the protective effect against high frequency interference signals remains.

Connection cable for Ex applications



Take note of the corresponding installation regulations for Ex applications. In particular, make sure that no potential equalisation currents flow over the cable screen. In case of grounding on both sides this can be achieved by the use of a capacitor or a separate potential equalisation.

5.2 Connection procedure

The pluggable terminals can be removed as needed to allow more convenient connection. To make the electrical connection, proceed as follows:

1. Mount the instrument as described in the previous chapter
2. Connect sensor cable 1 to terminal 1/2, and where applicable, connect the shielding
3. Connect sensor cable 2 to terminal 4/5, and where applicable, connect the shielding
4. When using several instruments on one sensor (Primary/Secondary operation), connect terminal 3 of all instruments together
5. Connect switched-off power supply to terminal 16/17
6. Connect relay 1 to terminal 10/11/12
7. Connect relay 2 to terminal 13/14/15

The electrical connection is finished.

5.3 Wiring plan

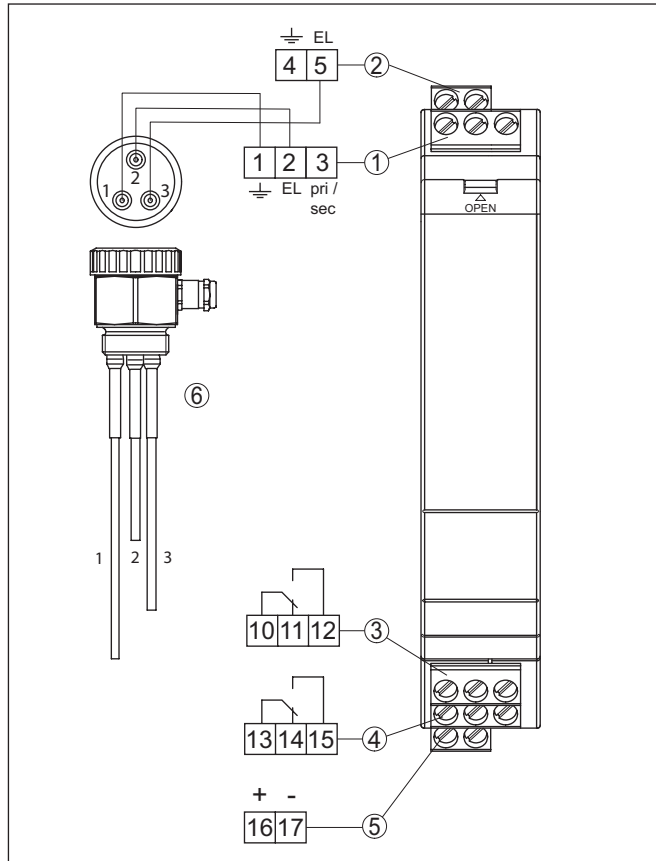

Fig. 1: Wiring plan VEGATOR 132

- 1 Sensor circuit 1 (terminal 1 + 2) and Primary/Secondary connection (terminal 3), max. level with two-point control
- 2 Sensor circuit 2 (terminal 4 + 5), min. level with two-point control
- 3 Relay output 1
- 4 Relay output 2
- 5 Voltage supply
- 6 Sensor

The terminals 1 and 4 are bridged internally. When using a single-rod electrode, terminals 1 or 4 are connected to the metallic vessel and terminals 2 and 5 to the respective electrode. When using double-rod electrodes, terminals 1 or 4 are connected to the longer rod and terminals 2 and 5 to the shorter one.

**Information:**

The connection terminals can be detached towards the front, if necessary. This can be useful when working in tight spaces or when exchanging an instrument.

5.4 Wiring plan four-channel control

Two VEGATOR 132 are required for a four-channel control which must be configured via the DIL switch to Primary/Secondary mode.

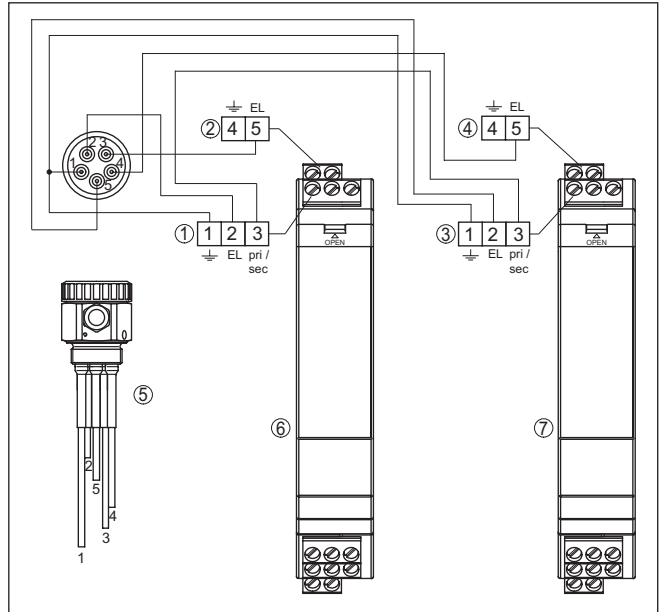

Fig. 2: Wiring plan VEGATOR 132

- 1 Sensor circuit 1 (terminal 1 + 2) and Primary/Secondary connection (terminal 3), max. level with two-point control
- 2 Sensor circuit 2 (terminal 4 + 5), min. level with two-point control
- 3 Sensor circuit 3 (terminal 1 + 2) and Primary/Secondary connection (terminal 3), max. level with two-point control
- 4 Sensor circuit 4 (terminal 4 + 5), min. level with two-point control
- 5 Sensor
- 6 VEGATOR 132 (Primary Device)
- 7 VEGATOR 132 (Secondary Device)

6 Setup

6.1 Adjustment system

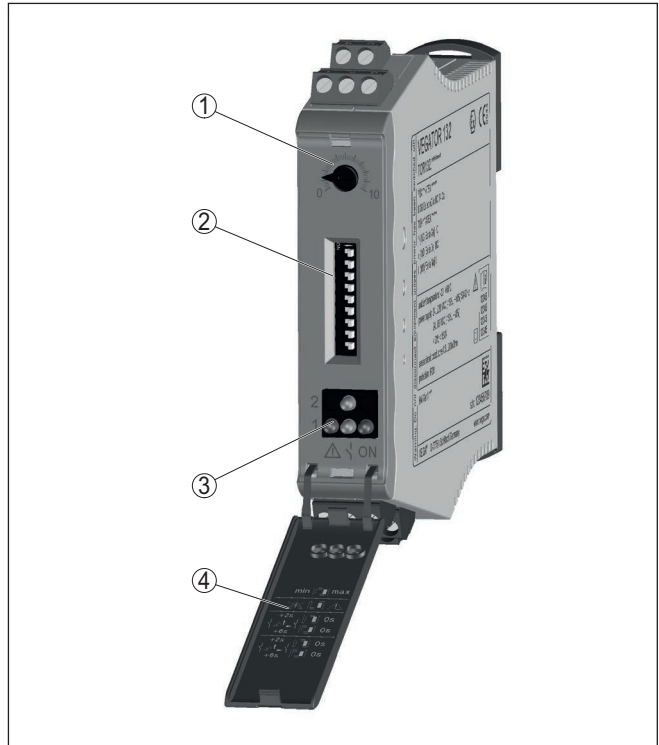

Fig. 3: Display and adjustment elements

- 1 Potentiometer for switching point adjustment
- 2 DIL switch block
- 3 Signal lamps (LEDs)
- 4 Hinged front cover

6.2 Adjustment elements

Control lamps

Control lamps (LED) in the front plate indicate operation, switching status and fault signal.

- Green
 - Operating control lamp
 - Mains voltage on, instrument is operating
- Red
 - Fault indicator
 - Fault on the sensor circuit due to sensor failure or line break
 - The relay deenergises in case of failure
- Yellow

- Relay control lamp
- Lights with activated (current-carrying) relay status

Front cover

The adjustment elements are located under a hinged front cover. To open it, use a small screwdriver in conjunction with the slot on the upper side of the front cover. To close it, push the cover at bottom and top firmly onto the front cover until you hear the two retaining clips snap in.

DIL switch block

The DIL switch block is located behind the front cover. The individual switches are assigned as follows:

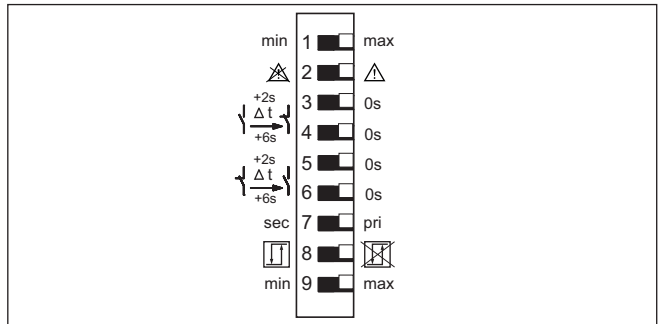

Fig. 4: DIL switch VEGATOR 132

- 1 Mode, channel 1 (min./max. adjustment)
- 2 Line monitoring, channel 1 Off/On
- 3 Switch-on delay 2 seconds
- 4 Switch-on delay 6 seconds
- 5 Switch-off delay 2 seconds
- 6 Switch-off delay 6 seconds
- 7 Switchover Primary/Secondary Device
- 8 Two-point control On/Off
- 9 Mode, channel 2 (min./max. adjustment)

Mode (min./max. adjustment)

The requested operating mode is set with the min./max. switch (min. detection i.e. dry run protection or max. detection i.e. overflow protection)

- **Dry run protection:** Relay is switched off when the level falls below the min. level (safe currentless state), relay is switched on again when the min. level is exceeded (switch-on point > switch-off point)
- **Overflow protection:** Relay is switched off when the max. level is exceeded (safe currentless state), relay is switched on again when the level falls below the max. level (switch-on point < switch-off point)

Line monitoring

The instrument offers the option of continuously monitoring the cable to the electrode for line break. The requirement is that a 220 kΩ resistor be connected between the two electrodes or between electrode and vessel. A detectable low current then flows even when the elec-

trode is uncovered (i.e. not immersed). If the signal line is interrupted, the red fault LED lights up.



Note:

The line monitoring is only carried out on channel 1. Channel 2 is not monitored and hence no 220 k Ω resistance is required. If there is a fault signal on channel 1, this will influence both outputs, relay 1 and relay 2 are then in safe state.



For Ex applications, the 220 k Ω resistor must be approved together with the sensor. For this purpose, we offer an approved resistor specially adapted to VEGA instruments. You can find further information in the documentation of the respective sensor.

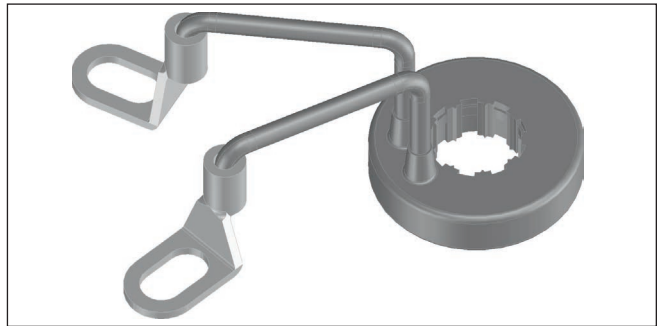

Fig. 5: Ex resistor for line monitoring with sensors of the EL series



Note:

Line monitoring may only be activated if a 220 k Ω resistor is connected between the two electrodes.

Switch-on/Switch-off delay

With these switches you can delay the changeover of the relays by the set time. This can be useful, e.g. with fluctuating product surfaces, for preventing unwanted switching commands. The switch-on/off delays can be set independently of each other. If both switches, e.g. of the switch-on delay, are activated, the times sum up. Delays of 2, 6 or 8 seconds can thus be adjusted.

Primary/Secondary Device

If several instruments are to be connected to the same electrodes, then all VEGATOR 132 must be connected together via terminal 3. One instrument must be configured as Primary Device, all others as Secondary Device. Through synchronization of the measurement voltages, faulty measurements due to crossover of measuring currents is avoided.

Two-point control

The following functionalities can be selected via this switch:

- Single point control (double channel level detection with the same switch on/switch off point)
- Two-point control (level detection with different switch on/switch off points)

As opposed to single point control, two-point control allows the switch-on and switch-off points to be set at different locations (hysteresis). Through the installation or the distance of the two electrodes, the hysteresis can be defined individually. Here, the max. level must be set to sensor input 1, the min. level to sensor input 2.

The two-point control is used for example when filling and emptying is carried out via a pump. The filling of a vessel can be for example switched on at 10 % and switched off again at 90 %. The output of the second channel behaves identically like the first channel provided the same mode is set. By changing the mode, the function of the relays can be inverted.

Switching point adjustment, limit level

With the potentiometer the switching point can be adapted to the conductivity of the medium. The further description can be found in the following chapter, depending on the operating mode.

6.3 Switch point adjustment with conductive sensor

When using a conductive level sensor, the switching point is determined by the mounting position or the length of the electrodes. The switching point is adapted to the medium to be measured via the potentiometer. Depending on the operating mode, set the switching point as described below.



Note:

In order to set a safe and precise switching point, the container must be filled. The electrode should be covered by approx. 1 cm. Note that the set switching point only applies to the medium currently filled. If the electrical conductivity of the medium changes, the switching point must be checked and reset if necessary.

Overflow protection (max. operation)

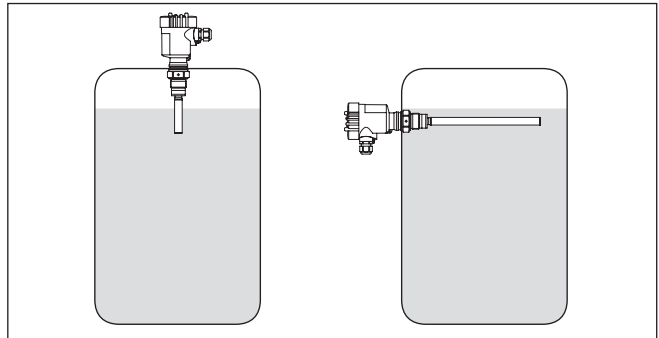

Fig. 6: Application examples of overflow protection with a conductive point level sensor

1. Make sure that switch 1 on the DIL switch block is set to "max.". The switches for the switch-on and switch-off delay should be set to "0 s".
2. The vessel should be empty i.e. the sensor must not be covered

3. Set the potentiometer to the left end position, the yellow LED display lights
4. Fill the vessel until the electrode is covered approx. 1 cm
5. Turn the potentiometer slowly clockwise until the yellow LED extinguishes. Turn the potentiometer a little further (approx. 2 scale lines) so that the switching point is always safely reached.

Dry run protection (min. operation)

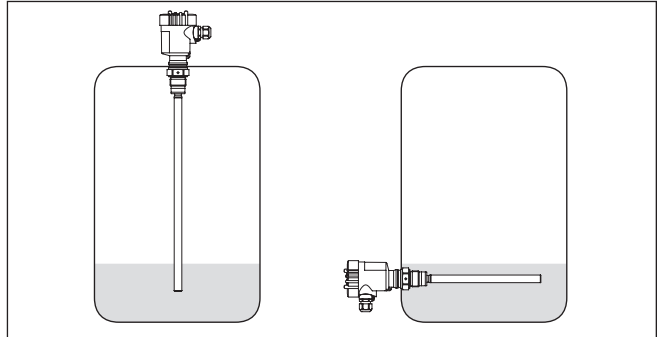

Fig. 7: Application examples of dry run protection with a conductive point level sensor

1. Make sure that switch 1 on the DIL switch block is set to "min.". The switches for the switch-on and switch-off delay should be set to "0 s".
2. The vessel should be empty i.e. the sensor must not be covered
3. Set the potentiometer to the left end position, the yellow LED display does not light
4. Fill the vessel until the electrode is covered approx. 1 cm
5. Turn the potentiometer slowly clockwise until the yellow LED lights up. Turn the potentiometer a little further (approx. 2 scale lines) so that the switching point is always safely reached.

6.4 Proof test



Note:

When handling environmentally hazardous substances, danger to the environment and to persons must be avoided. After setup, the proper functioning of the instrument must be ensured by means of the proof test described below.









- **Detection of line break:** Disconnect the sensor cable for the duration of this test
 - The red fault LED must light up
 - The relay must be deenergized
- **Switching point monitoring (overflow protection):** Fill the vessel up to the set switching point
 - When the switching point is reached, the respective relay must deenergize

- **Switching point monitoring (dry run protection):** Empty the vessel down to the set switching point
 - When the switching point is reached, the respective relay must deenergize









6.5 Function table "Point level"

The following table provides an overview of the switching conditions depending on the set mode and the level.

Overfill protection, point level (max.)

| Sensor | | Controller | | |
|---|-----------|---|---|-------|
| Level | Electrode | LED yellow (output) | LED red (fault) | Relay |
|  | Uncovered |  |  | ON |
|  | Covered |  |  | OFF |
| any | any |  |  | OFF |

















Dry run protection, point level (min.)

| Sensor | | Controller | | |
|---|-----------|---|---|-------|
| Level | Electrode | LED yellow (output) | LED red (fault) | Relay |
|  | Covered |  |  | ON |
|  | Uncovered |  |  | OFF |
| any | any |  |  | OFF |









6.6 Function table, two-point control









The following charts provide an overview of the switching conditions depending on the set mode and the level.

Overfill protection, two-point control

| Sensor | | Controller | | |
|---|-----------|---|---|-------|
| Level | Electrode | LED yellow (output) | LED red (fault) | Relay |
|  | Uncovered |  |  | ON |
| | Uncovered | | | |
|  | Uncovered |  |  | ON |
| | Covered | | | |
|  | Covered |  |  | OFF |
| | Covered | | | |
|  | Uncovered |  |  | OFF |
| | Covered | | | |
|  | Uncovered |  |  | ON |
| | Uncovered | | | |
| any | any |  |  | OFF |

Dru run protection, two-point control

| Sensor | | Controller | | |
|---|-----------|---|---|-------|
| Level | Electrode | LED yellow (output) | LED red (fault) | Relay |
|  | Uncovered |  |  | OFF |
| | Uncovered | | | |
|  | Uncovered |  |  | OFF |
| | Covered | | | |
|  | Covered |  |  | ON |
| | Covered | | | |

| Sensor | | Controller | | |
|---|-----------|---|---|-------|
| Level | Electrode | LED yellow (output) | LED red (fault) | Relay |
|  | Uncovered |  |  | ON |
| | Covered | | | |
|  | Uncovered |  |  | OFF |
| | Uncovered | | | |
| any | any |  |  | OFF |

7 Diagnostics and servicing

7.1 Maintenance

Maintenance

If the device is used properly, no special maintenance is required in normal operation.

Cleaning

The cleaning helps that the type label and markings on the instrument are visible.

Take note of the following:

- Use only cleaning agents which do not corrode the housings, type label and seals
- Use only cleaning methods corresponding to the housing protection rating

7.2 Rectify faults

Reaction when malfunction occurs

The operator of the system is responsible for taking suitable measures to rectify faults.

Causes of malfunction

The device offers maximum reliability. Nevertheless, faults can occur during operation. These may be caused by the following, e.g.:

- Measured value from sensor not correct
- Voltage supply
- Interference in the cables

Fault rectification

The first measure to be taken is to check the input and output signals. The procedure is described as follows. In many cases the causes can be determined this way and faults can be easily rectified.

Reaction after fault rectification

Depending on the reason for the fault and the measures taken, the steps described in chapter "Setup" must be carried out again or must be checked for plausibility and completeness.

24 hour service hotline

Should these measures not be successful, please call in urgent cases the VEGA service hotline under the phone no. **+49 1805 858550**.

The hotline is also available outside normal working hours, seven days a week around the clock.

Since we offer this service worldwide, the support is provided in English. The service itself is free of charge, the only costs involved are the normal call charges.

7.3 Diagnosis, fault messages

Fault signal

The controller and the connected sensors are permanently monitored during operation. If irregularities occur, a fault signal is triggered. In the event of a failure, the fault indication lights up and the relays are de-energized (safe state).

Red fault LED lights up

| Cause | Rectification |
|--------------------------------------|---|
| Sensor not connected correctly | <ul style="list-style-type: none"> ● Check the electrical connection according to the wiring diagrams |
| Line break | <ul style="list-style-type: none"> ● Check the electrical connection cables from the sensor to the controller |
| Sensor without line break monitoring | <ul style="list-style-type: none"> ● Check if there is a 220 kΩ resistor between the two electrodes in the sensor ● Install a 220 kΩ resistor or deactivate line break monitoring |

Controller does not switch

| Cause | Rectification |
|---|---|
| Operating voltage missing (green control lamp is off) | <ul style="list-style-type: none"> ● Check the electrical connection according to the wiring diagrams |
| Controller defective | <ul style="list-style-type: none"> ● Exchange VEGATOR 132 |
| Probe mechanically damaged | <ul style="list-style-type: none"> ● Exchange probe |
| Conductivity of the product too low | <ul style="list-style-type: none"> ● Check if the electric conductance of your product is at least 7.5 μS/cm |
| Welded contacts - for example after a short-circuit | <ul style="list-style-type: none"> ● Exchange VEGATOR 132. If necessary, integrate a fuse into the contact circuit |

Switching function wrong

| Cause | Rectification |
|--|--|
| Wrong operating mode (min./max. switch-over) set | <ul style="list-style-type: none"> ● Set the correct mode on the DIL switch block |

7.4 How to proceed if a repair is necessary

You can find an instrument return form as well as detailed information about the procedure in the download area of our homepage. By doing this you help us carry out the repair quickly and without having to call back for needed information.

In case of repair, proceed as follows:

- Print and fill out one form per instrument
- Clean the instrument and pack it damage-proof
- Attach the completed form and, if need be, also a safety data sheet outside on the packaging
- Ask the agency serving you to get the address for the return shipment. You can find the agency on our homepage.

8 Dismount

8.1 Dismounting steps

Take note of chapters "*Mounting*" and "*Connecting to voltage supply*" and carry out the listed steps in reverse order.

8.2 Disposal

The device is made of recyclable materials. For this reason, it should be disposed of by a specialist recycling company. Observe the applicable national regulations.

9 Certificates and approvals

9.1 Approvals for Ex areas

Approved versions for use in hazardous areas are available or in preparation for the device series.

You can find the relevant documents on our homepage.

9.2 EU conformity

The device fulfils the legal requirements of the applicable EU directives. By affixing the CE marking, we confirm the conformity of the instrument with these directives.

The EU conformity declaration can be found on our homepage.

9.3 Environment management system

Protection of the environment is one of our most important duties. That is why we have introduced an environment management system with the goal of continuously improving company environmental protection. The environment management system is certified according to DIN EN ISO 14001. Please help us fulfil this obligation by observing the environmental instructions in chapters "*Packaging, transport and storage*", "*Disposal*" of these operating instructions.

10 Supplement

10.1 Technical data

Note for approved instruments

The technical data in the respective safety instructions are valid for approved instruments (e.g. with Ex approval). In some cases, these data can differ from the data listed herein.

All approval documents can be downloaded from our homepage.

General data

| | |
|----------------------|---|
| Series | Module unit for mounting on carrier rails 35 x 7.5 acc. to EN 50022/60715 |
| Weight | 125 g (4.02 oz) |
| Housing material | Polycarbonate PC-FR |
| Connection terminals | |
| – Type of terminal | Screw terminal |
| – Wire cross-section | 0.25 mm ² (AWG 23) ... 2.5 mm ² (AWG 12) |

Voltage supply

| | |
|------------------------|---------------------------------------|
| Operating voltage | |
| – Nominal voltage AC | 24 ... 230 V (-15 %, +10 %), 50/60 Hz |
| – Nominal voltage DC | 24 ... 65 V (-15 %, +10 %) |
| Max. power consumption | 2 W (8 VA) |

Sensor input

| | |
|--|--|
| Quantity | 2 x for connection of a conductive electrode |
| Input type | Active (sensor power supply by VEGATOR 132) |
| Measured value transmission | Alternating voltage |
| Response resistor | 500 Ω ... 200 kΩ, adjustable |
| Hysteresis | 100 Ω ... 100 kΩ |
| Terminal voltage (idle state) | 10 V _{ss} rectangular voltage 75 Hz |
| Line break monitoring | |
| – Detection line break | > 500 kΩ |
| – Recommended resistance in the sensor | 220 kΩ |
| Permissible line capacitance | 200 nF |

Relay output

| | |
|-------------------|---------------------------------------|
| Quantity | 2 x operating relay |
| Contact | Floating spdt |
| Contact material | AgSnO ₂ , hard gold-plated |
| Switching voltage | min. 10 mV DC, max. 253 V AC/50 V DC |
| Switching current | min. 10 μA DC, max. 3 A AC, 1 A DC |

| | |
|---------------------------------|---------------------------------------|
| Breaking capacity ¹⁾ | min. 50 mW, max. 500 VA, max. 54 W DC |
| Phase angle $\cos \phi$ with AC | ≥ 0.7 |
| Switch-on/Switch-off delay | |
| – Basic delay | 250 ms, $\pm 20 \%$ |
| – Adjustable delay | 2/6/8 s, $\pm 20 \%$ |

Indicators

LED displays

| | |
|-----------------------------|----------------|
| – Status, operating voltage | 1 x LED green |
| – Status, fault signal | 1 x LED red |
| – Status, operating relay | 2 x LED yellow |

Adjustment

| | |
|-------------------|--|
| 9 x DIL switch | Setting mode of operation, two-point control, switching delay, line monitoring, Primary/Secondary Device |
| 1 x potentiometer | for switching point adjustment |

Ambient conditions

| | |
|--|----------------------------------|
| Ambient temperature at the installation site of the instrument | -20 ... +60 °C (-4 ... +140 °F) |
| Storage and transport temperature | -40 ... +70 °C (-40 ... +158 °F) |
| Relative humidity | < 96 % |

Mechanical environmental conditions

| | |
|----------------------------|--|
| Vibrations (oscillations) | Class 4M4 acc. to IEC 60721-3-4 (1 g, 4 ... 200 Hz) |
| Impacts (mechanical shock) | Class 6M4 acc. to IEC 60721-3-6 (10 g/11 ms, 30 g/6 ms, 50 g/2.3 ms) |

Electrical protective measures

| | |
|---|------|
| Protection rating | IP20 |
| Overvoltage category (IEC 61010-1) | |
| – up to 2000 m (6562 ft) above sea level | III |
| – up to 5000 m (16404 ft) above sea level | II |
| Pollution degree | 2 |

Measures for electrical separation

| | |
|---|-----------|
| Reliable separation according to VDE 0106 part 1 between all circuits | |
| – Reference voltage | 253 V AC |
| – Insulation resistance | 5.1 kV DC |

Approvals

Instruments with approvals can have different technical specifications depending on the version.

¹⁾ If inductive loads or stronger currents are switched through, the gold plating on the relay contact surface will be permanently damaged. The contact is then no longer suitable for switching low-level signal circuits.

For that reason the associated approval documents of these instruments have to be carefully noted. They are part of the delivery or can be downloaded by entering the serial number of your instrument into the search field under www.vega.com as well as in the general download area.

10.2 Dimensions

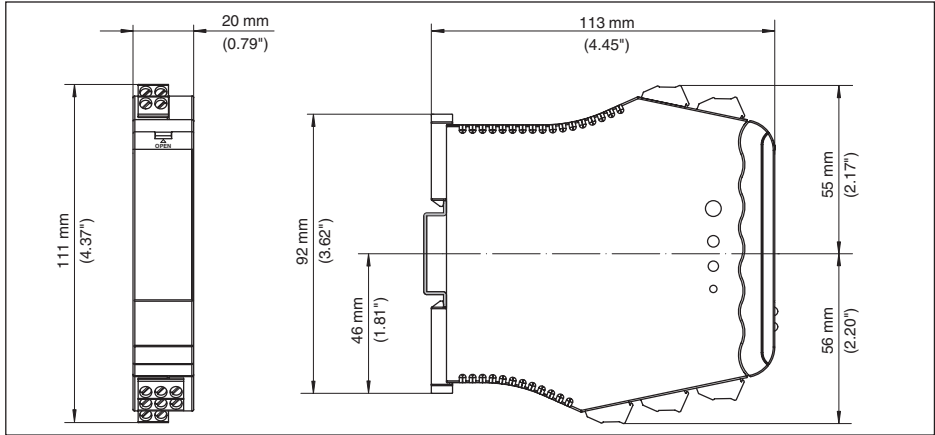

Fig. 8: Dimensions VEGATOR 132

10.3 Industrial property rights

VEGA product lines are global protected by industrial property rights. Further information see www.vega.com.

VEGA Produktfamilien sind weltweit geschützt durch gewerbliche Schutzrechte.

Nähere Informationen unter www.vega.com.

Les lignes de produits VEGA sont globalement protégées par des droits de propriété intellectuelle. Pour plus d'informations, on pourra se référer au site www.vega.com.

VEGA líneas de productos están protegidas por los derechos en el campo de la propiedad industrial. Para mayor información revise la pagina web www.vega.com.

Линии продукции фирмы ВЕГА защищаются по всему миру правами на интеллектуальную собственность. Дальнейшую информацию смотрите на сайте www.vega.com.

VEGA系列产品在全球享有知识产权保护。

进一步信息请参见网站 < www.vega.com。

10.4 Trademark

All the brands as well as trade and company names used are property of their lawful proprietor/originator.

INDEX**C**

Cable screen 10
Carrier rail 9
Causes of malfunction 22
Connection 12
Connection cable 10
Connection four-channel control 13
Connection terminals 11
Control lamps 14

D

DIL switch 15
Documentation 7
Dry run protection 15

E

Ex version 9

F

Fault
– Fault signal 22
Fault rectification 22

G

Grounding 10

H

Hysteresis 16

L

LEDs 14
Limit level 17
Line monitoring 15

M

Mode 15

O

Overflow protection 15

P

Potential equalisation 10
Potentiometer 17
Primary/Secondary Device 16
Protection rating 9

Q

QR code 7

R

Repair 23

S

Serial number 7
Service hotline 22
Switching point adjustment 17
Switch-off delay 16
Switch-on delay 16

T

Two-point control 16
Type label 7

V

Voltage supply 10



Printing date:

VEGA

All statements concerning scope of delivery, application, practical use and operating conditions of the sensors and processing systems correspond to the information available at the time of printing.

Subject to change without prior notice

© VEGA Grieshaber KG, Schiltach/Germany 2021



46837-EN-210714

VEGA Grieshaber KG
Am Hohenstein 113
77761 Schiltach
Germany

Phone +49 7836 50-0
E-mail: info.de@vega.com
www.vega.com