

# DIGITAL GAUGES

## PRODUCT CATALOGUE



PRESSURE at the highest LEVEL.

**BD|SENSORS**  
pressure measurement

>> [www.bdsensors.de](http://www.bdsensors.de)



# PRESSURE AT THE HIGHEST LEVEL

„Successful medium-sized companies are not successful because they are active in many areas, but rather because they concentrate on one area and do it better than anyone else“

This is our philosophy. That's why BDESENSORS has concentrated on electronic pressure measurement technology from the beginning.

With our unremitting product and quality strategy we have been successful in becoming a major player on the world market for electronic pressure sensing devices within a few years.

With 260 employees at 4 locations in Germany, the Czech Republic, Russia and China BD|SENSORS has solutions from 0.1 mbar to 6000 bar:

- > pressure sensors, pressure transducers  
pressure transmitters

---

- > electronic pressure switches

---

- > pressure measuring devices with display and  
switching outputs

---

- > hydrostatic level probes

---

Two pressure transmitters and a submersible probe, based on a stainless steel silicon sensor were the beginning. Today the range extends to more than 70 standard products, from economical OEM devices to high-end products with HART® communication or field bus interface.

In addition we have developed hundreds of customer-specific applications, underlining the competence and flexibility of BD|SENSORS. The excellent price/performance ratio of our products is proof of the fact that we are able to meet the toughest demand: Being a problem-solver for our customers.

For large production batches as well as for small production numbers, no matter for what medium or external factors, with almost any mechanical or electrical connection - we solve your problem

**flexibly, quickly and cost-efficiently.**

## INDEX

PRECISION	4-17
DM01	4-10
DL01	11-17
INDUSTRY	18-30
BAROLI 02	18-20
BAROLI 02 P	21-24
BAROLI 05	25-27
BAROLI 05 P	28-30
OEM	31-36
DM10	31-33
DM17	34-36
4 ADVANTAGES	38



# DM 01

## Battery Powered Precision Digital Gauge

Stainless Steel Sensor

class 0.05

### Nominal pressure

from 0 ... 100 mbar up to 0 ... 400 bar

### Special characteristics

- ▶ modular sensor concept
- ▶ data logger
- ▶ graphic display
- ▶ stainless steel housing Ø100 mm
- ▶ communication interface USB 2.0

### Optional

- ▶ accredited calibration certificate according to DKD / DAkkS
- ▶ IS-version zone 0/1
- ▶ software incl. USB converter
- ▶ service case with accessories

### Functions

- ▶ zero point calibration
- ▶ data logger
- ▶ turn off automatic
- ▶ free button assignment
- ▶ background illumination etc.

The digital pressure gauge DM 01 is a precision device fulfilling highest demands. It was conceived especially for the process monitoring and calibration.

The advantage: The DM 01 consists of two devices - the digital display and a pressure transmitter. The pressure transmitter can be selected on site for different measuring ranges and connected to the display - without tools or parameter setting.

Outstanding measuring qualities, an intuitive operation, as well as an innovative, modular sensor concept characterise the DM 01. The battery-powered digital pressure gauge can be used e.g. for controlling pressure courses or calibrating pressure transmitters.

The integrated data logger is able to record pressure and temperature values linearly and cyclically which can be analysed with the software DAQ.

### Preferred areas of use are



Calibrating techniques



Laboratory applications



Plant and machine engineering





Input pressure													
Nominal pressure gauge	[bar]	-1...0	0.10	0.16	0.25	0.40	0.60	1	1.6	2.5	4	6	
Nominal pressure abs.	[bar]	-	-	-	-	0.40	0.60	1	1.6	2.5	4	6	
Overpressure	[bar]	5	1	1	1	2	5	5	10	10	17.5	35	
Burst pressure $\geq$	[bar]	7.5	1.5	1.5	1.5	3	7.5	7.5	15	15	25	50	
Nominal pressure gauge / abs.	[bar]	10	16	25	40	60	100	160	250	400			
Overpressure	[bar]	35	80	80	105	210	600	600	1000	1000			
Burst pressure $\geq$	[bar]	50	120	120	210	420	1000	1000	1250	1250			
Vacuum resistance		$P_N \geq 1$ bar: unlimited vacuum resistant; $P_N < 1$ bar: on request											
Performance													
Accuracy <sup>1</sup>		nominal pressure $P_N \geq 0.4$ bar: $\leq \pm 0.05$ % FSO BFSL nominal pressure $P_N < 0.4$ bar: $\leq \pm 0.125$ % FSO BFSL											
Long term stability		$\leq \pm 0.1$ % FSO / year at reference conditions											
Measuring rate / Display		1, 2 or 50 measurements per second											
<sup>1</sup> accuracy according to IEC 60770 – minimum value setting (non-linearity, hysteresis, repeatability) - at room temperature 20°C													
Thermal effects (offset and span)													
Temperature error		for nominal pressure ranges $P_N \leq 160$ bar: tolerance band $\leq \pm 0.2$ % FSO for nominal pressure ranges $P_N > 160$ bar: tolerance band $\leq \pm 0.75$ % FSO											
compensated range		0 ... 50 °C											
Permissible temperatures													
Permissible temperatures		medium: -10 ... 55 °C				environment: display module: -10 ... 55 °C				storage: -20 ... 70 °C transmitter: -20 ... 70 °C (at 1G to +60 °C)			
Materials													
Pressure port / housing		stainless steel 1.4404 (316L)											
Display housing		stainless steel 1.4301 (304)											
Seals (media wetted)		FKM, without (welded version) and others on request											
Diaphragm		stainless steel 1.4435 (316L)											
Media wetted parts		pressure port, seal, diaphragm											
Explosion protection													
AX16-DM01		IBExU12ATEX1108 X variant with standard front foil for zone 1: II 2G Ex ia IIB T4 Gb variant with conductive front foil for zone 0: II 1G Ex ia IIC T4 Ga (on request)											
Miscellaneous													
Display		graphic LC display: visible area 55 x 46 mm; (resolution 128x64) figure height 5.5 mm (displaying of pressure value) measured value display: max. 7 digits, depending on pressure range temperature display, time, 100-segment-bargraph, potential input value background illumination: illumination period and intensity adjustable											
Temperature display range		accuracy: $\pm 2$ K resolution: 0.1 K display: -10 ... 55 °C											
Adjustable units pressure and temperature		[mbar], [bar], [psi], [mmHg], [cmHg], [inHg], [kPa], [MPa], [hPa], [mmH <sub>2</sub> O], [mH <sub>2</sub> O], [inH <sub>2</sub> O], [kg/cm <sup>2</sup> ], [°C], [°F], [K]											
Data logger		modes: single, cyclic, linear, off recording pressure values and sensor temperature measuring value interval adjustable (hrs, min, sec, 20 ms, daily at a defined time) measurement rate adjustable (1/s, 2/s or 50/s only with 20 ms measured value interval) max. 600798 values											
Current consumption		without background illumination: approx. 1.3 mA with background illumination: approx. 16 mA (depending on adjusted intensity) standby mode: approx. 1.2 $\mu$ A											
Supply		3x 1.5 V: Duracell Plus battery, DUR087033, AA (LR6)											
Ingress protection		IP 67											
Mounting position <sup>2</sup>		any											
Weight		approx. 680 g											
A / D-converter resolution		16 bit (module)											
Battery life		standard use: > 2.000 h					standby mode: at least 5 years (with measurement rate 1/s and 2/s)						
Operational life		100 million load cycles											
CE-conformity		EMC directive: 2014/30/EU pressure equipment directive: 2014/68/EU (Module A) <sup>3</sup> electromagnetic compatibility: according to EN 6132											
<sup>2</sup> Pressure transmitters are calibrated in a vertical position with the pressure connection down. If this position is changed on installation there can be slight deviations in the zero point for pressure ranges $P_N \leq 1$ bar.													
<sup>3</sup> This directive is only valid for devices with maximum permissible overpressure > 200 bar.													

**Dimensions (in mm)**

**standard**

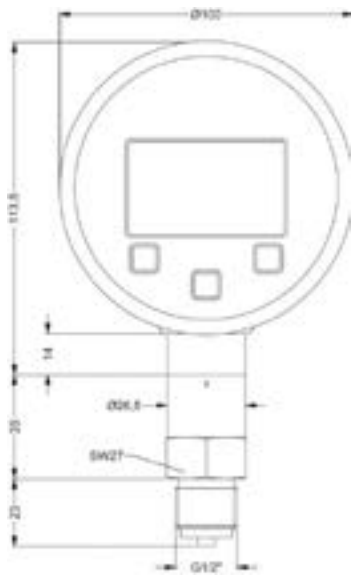

G1/2" EN 837

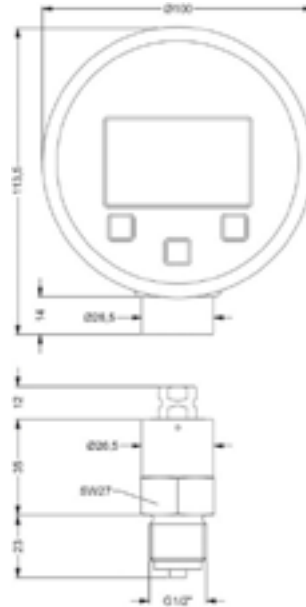

G1/2" EN 837  
(pressure transmitter and display separated)

**option**

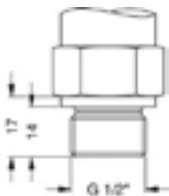

G1/2" DIN 3852

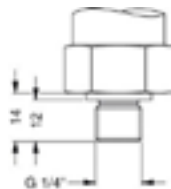

G1/4" DIN 3852

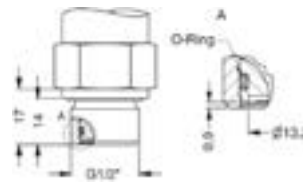

G1/2" DIN 3852  
with flush sensor <sup>4</sup>

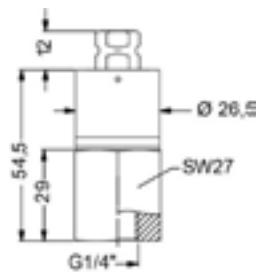

G1/4" EN 837  
internal thread, welded <sup>4,5</sup>

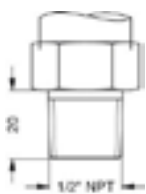

1/2" NPT

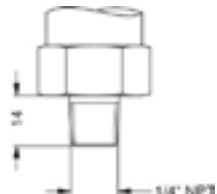

1/4" NPT

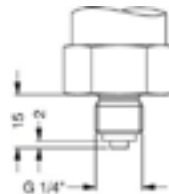

G 1/4" EN 837

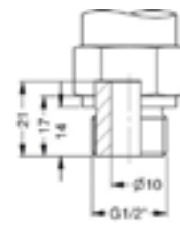

G1/2" DIN 3852 open pressure port <sup>4</sup>

⇒ metrical threads and other variations on request

<sup>4</sup> only possible for nominal pressure ranges  $P_N \leq 40$  bar

<sup>5</sup> different connection versions with optional adapters possible (see accessories)

Further pressure sensor modules can be combined to the advertisement unity DM01-A21 and DM01-A2E. an overview of available pressure sensor modules and characteristics you will find in the following matrix:

Pressure sensor module						
Name	Pressure range	Filling fluid	diaphragm	accuracy	Special feature	further information
<b>M0</b>	0...0.1 bar up to 0...400 bar	silicone oil	stainless steel 1.4435	0.05% FSO	very high precision	see data sheet
<b>M4</b>	0...6 bar up to 0...600 bar	none; welded version	stainless steel 1.4542	0.25% FSO	i.a. for oxygen; oil and grease free	on request
<b>M7</b>	0...0.1 bar up to 0...10 bar	none	ceramic Al <sub>2</sub> O <sub>3</sub> 96%	0.15% FSO	high overpressure	on request

Accessories

**Accessories are not in scope of supply and have to be ordered separately!**

**Software DAQ** (Communication, Configuration, Measurement display, Protocol creation)

Optionally software DAQ and an interface cable can be ordered. The software is also available for download on our homepage.

**Software:**

- display of device information (serial number, pressure and temperature range, ...)
- configuration area for all parameters
- download area for recorded data:
  - date
  - pressure measurement
  - temperature measurement
- protected data acquisition
- measured value representation in tabular or graphic form
- free scaling of the diagram
- creation of measurement / test report as a PDF file
- data export

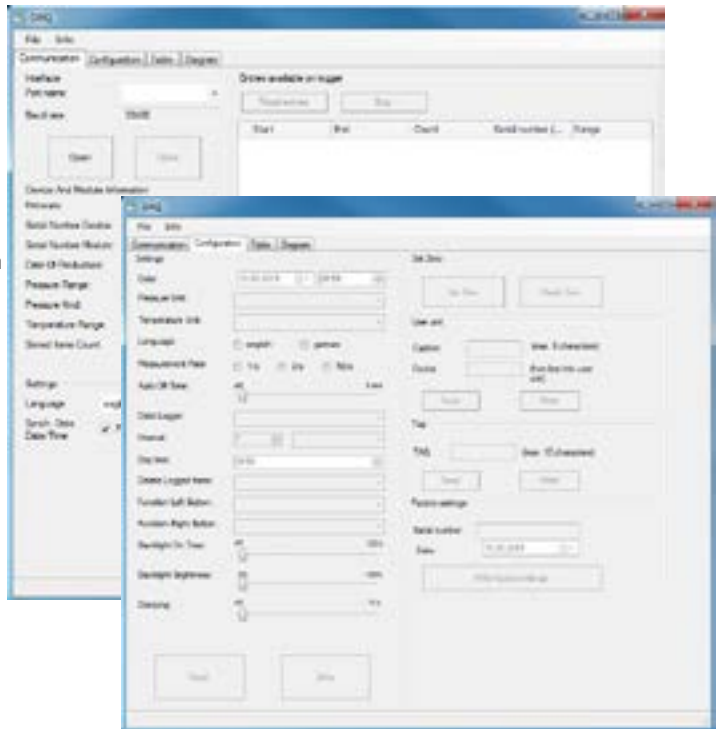

Interface cable USB (type A) to mini connector (3.5 mm) with integrated converter  
l: 1.7 m

Ordering number: ZUSBCD01

**Pressure sensor module DM01, pressure port G 1/4" EN 837 internal thread, welded**

<p>G 1/4" EN 837</p> <p>Ordering number: Z5010203</p>	<p>Adapter for pressure sensor module with pressure port G 1/4" EN 837 internal thread, welded</p> <p>external thread: G 1/4" EN 837 external thread: G 1/4" EN 837</p>	<p>1/4" NPT</p> <p>Ordering number: Z5010204</p>	<p>Adapter for pressure sensor module with pressure port G 1/4" EN 837 internal thread, welded</p> <p>external thread: G 1/4" EN 837 external thread: 1/4" NPT</p>
<p>G 1/2" EN 837</p> <p>Ordering number: Z5010202</p>	<p>Adapter for pressure sensor module with pressure port G 1/4" EN 837 internal thread, welded</p> <p>external thread: G 1/4" EN 837 external thread: G 1/2" EN 837</p>	<p>1/2" NPT</p> <p>Ordering number: Z5010205</p>	<p>Adapter for pressure sensor module with pressure port G 1/4" EN 837 internal thread, welded</p> <p>external thread: G 1/4" EN 837 external thread: 1/2" NPT</p>

\* others on request

<p>Hard-shell service case without accessories</p> <p>Service_Case_DM01</p>		<p>Hard shell case.</p> <p>Dimension in mm (L x W x H): 432 X 363 X 138</p>
<p>Protective cap</p> <p>Ordering number: Z1002648</p>		<p>Rubber protection</p>
<p>Additional batteries (only in combination with service case)</p>		<p>for IS-version use only</p> <ul style="list-style-type: none"> <li>• 3 x 1.5 V / AA Duracell Power Plus</li> </ul>
<p>Seal set (only in combination with service case)</p>		<p>Flat seal copper for mechanical connections according to EN 837</p>
<p>PTFE seal tape Nr. 498.505 (only in combination with service case)</p>		<p>Seal tape for mechanical connections material: PTFE (Teflon) Temperature range: -200 ... 280 °C</p>
<p>Wrench (only in combination with service case)</p>		<p>Wrench SW 27</p>
<p>Calibration test pump KHP 35</p> <p>Ordering number: 1002637</p>		<p>The KHP 35 calibration test pump is used to generate pressure and vacuum for checking, adjusting and calibrating mechanical and electronic pressure measuring instruments by comparative measurements. These pressure tests may be carried out in laboratories, workshop or on site at the measuring point.</p> <p>pressure: 0 ... 35 bar vacuum: 0 ... -0.95 bar weight: ca. 510 g dimension: ca. 220 x 105 x 63 mm</p>
<p><b>Adapter for calibration test pump</b></p>		
<p>Test unit connection:</p> <p>Adapter to connect the test unit to the calibration test pump.</p>		<p>Adapter to connect the test unit to the calibration test pump.</p> <p>external thread: G 1/4" EN 837 to: internal thread: G 1/4" DIN 3852 (No. 5008909) or G 1/2" EN o. DIN (No. 5007896) or 1/4" NPT (No. 5007897) or 1/2" NPT (No. 5007898)</p> <p>others on request</p>
<p>Reference unit connection:</p> <p>Adapter to connect the digital gauge to the calibration test pump</p>		<p>Adapter to connect the pressure sensor module DM01 to the calibration test pump.</p> <p>external thread: G 1/2" EN 837 to: internal thread: G 1/4" DIN 3852 (No. 5012498) or G 1/2" DIN 3852 (No. 5012519) or 1/4" NPT (No. 5012499) or 1/2" NPT (No. 5012500)</p> <p>others on request</p>





## Accessories DM 01

Accessories	
USB converter (incl. software DAQ on USB stick)	ZUSBCD01
service case (without accessories)	Service_Case_DM01
Protective cap	Z1002648
additional batteries (3 x 1.5 V / AA Duracell Power Plus) <sup>4</sup>	1002798
Seal set <sup>4</sup>	5008886
PTFE seal tape <sup>4</sup>	1002724
wrench <sup>4</sup>	1002722
calibration test pump (KHP)	1002637
Adapter for DM 01	
G1/4" EN 837 male - G1/4" EN 837 male	Z5010203
G1/4" EN 837 male - G1/2" EN 837 male	Z5010202
G1/4" EN 837 male - 1/4" NPT male	Z5010204
G1/4" EN 837 male - 1/2" NPT male	Z5010205
Adapter for KHP - test unit connection	
G1/4" EN 837 m - G1/4" DIN3852 fm	5008909
G1/4" EN 837 m - G1/2" EN 837/DIN3852 fm	5007896
G1/4" EN 837 m - 1/4" NPT fm	5007897
G1/4" EN 837 m - 1/2" NPT fm	5007898
Adapter for KHP - reference unit connection	
G1/2" EN 837 m - G1/4" DIN3852 fm	5012498
G1/2" EN 837 m - G1/2" DIN3852 fm	5012519
G1/2" EN 837 m - 1/4" NPT fm	5012499
G1/2" EN 837 m - 1/2" NPT fm	5012500

<sup>4</sup> only in combination with service case



# DL 01

## Battery Powered Precision Digital Gauge for Leak Testing

Stainless Steel Sensor

class 0.05

### Nominal pressure

from 0 ... 100 mbar up to 0 ... 400 bar

### Special characteristics

- ▶ modular sensor concept
- ▶ data logger
- ▶ graphic display
- ▶ stainless steel housing Ø100 mm
- ▶ communication interface USB 2.0

### Optional

- ▶ accredited calibration certificate according to DKD / DAkkS
- ▶ IS-version zone 0/1
- ▶ software incl. USB converter
- ▶ service case with various accessories

### Functions

- ▶ data logger interval  
1 s ... 99 days or fixed time
- ▶ default values for time / test duration
- ▶ zero point calibration
- ▶ backlight and much more

The digital pressure gauge DL 01 is a precision device fulfilling highest demands. It was conceived especially for leak testing or pipeline monitoring.

In the leakage mode the device shows the pressure decrease during an adjustable time. After finishing of measurement, the result is shown in the display.

Outstanding measuring qualities, an intuitive operation, as well as an integrated data logger characterize the DL 01. In addition, the graphic display provides the handling and the clear presentation of the measuring procedure.

The gathered data and the relevant information (TAG or serial number, etc.) are recorded and can be read out and processed over the integrated interface via USB and PC software.

### Preferred areas of use are



Plant and machine engineering

- Pipeline monitoring
- Leak testing



Input pressure												
Nominal pressure gauge	[bar]	-1...0	0.10	0.16	0.25	0.40	0.60	1	1.6	2.5	4	6
Nominal pressure abs.	[bar]	-	-	-	-	0.40	0.60	1	1.6	2.5	4	6
Overpressure	[bar]	5	1	1	1	2	5	5	10	10	17.5	35
Burst pressure $\geq$	[bar]	7.5	1.5	1.5	1.5	3	7.5	7.5	15	15	25	50
Nominal pressure gauge / abs.	[bar]	10	16	25	40	60	100	160	250	400		
Overpressure	[bar]	35	80	80	105	210	600	600	1000	1000		
Burst pressure $\geq$	[bar]	50	120	120	210	420	1000	1000	1250	1250		
Vacuum resistance		$p_N \geq 1$ bar: unlimited vacuum resistance; $p_N < 1$ bar: on request										
Performance												
Accuracy <sup>1</sup>		nominal pressure $p_N \geq 0.4$ bar: $\leq \pm 0.05$ % FSO BFSL nominal pressure $p_N < 0.4$ bar: $\leq \pm 0.125$ % FSO BFSL										
Long term stability		$\leq \pm 0.1$ % FSO / year at reference conditions										
Measuring rate / Display		1 or 2 measurements per second										
<sup>1</sup> accuracy according to IEC 60770 – minimum value setting (non-linearity, hysteresis, repeatability) – at room temperature 20°C												
Thermal effects (offset and span)												
Temperature error		for nominal pressure ranges $p_N \leq 160$ bar: tolerance band $\leq \pm 0.2$ % FSO for nominal pressure ranges $p_N > 160$ bar: tolerance band $\leq \pm 0.75$ % FSO										
compensated range		0 ... 50 °C										
Permissible temperatures												
Permissible temperatures		medium: -10 ... 55 °C storage: -20 ... 70 °C environment: display module: -10 ... 55 °C / transmitter: -20 ... 70 °C (for 1G up to +60 °C)										
Materials												
Pressure port / housing		stainless steel 1.4404 (316L)										
Display housing		stainless steel 1.4301 (304)										
Seals (media wetted)		FKM, without (welded version)										
Diaphragm		stainless steel 1.4435 (316L)										
Media wetted parts		pressure port, seal, diaphragm										
Explosion protection												
AX16-DL01		IBExU12ATEX1108 X variant with standard front foil for zone 1: II 2G Ex ia IIB T4 Gb variant with conductive front foil for zone 0: II 1G Ex ia IIC T4 Ga										
Miscellaneous												
Display		graphic LC display: visible area 55 x 46 mm; (resolution 128x64) figure height 5.5 mm (displaying of pressure value) measured value display: max. 7 digits, depending on pressure range temperature display, time, 100-segment-bargraph, potential input value background illumination: illumination period and intensity adjustable										
Temperature display range		accuracy: $\pm 2$ K resolution: 0,1 K display: -10 ... 55 °C										
Adjustable units pressure and temperature		[mbar], [bar], [psi], [mmHg], [cmHg], [inHg], [kPa], [MPa], [hPa], [mmH <sub>2</sub> O], [mH <sub>2</sub> O], [inH <sub>2</sub> O], [kg/cm <sup>2</sup> ], [°C], [°F], [K]										
Data logger		modes: single, cyclic, linear, off recording pressure values and sensor temperature measuring value interval adjustable (hrs, min, sec, 20 ms, daily at a defined time) measurement rate adjustable (1/s, 2/s or 50/s only with 20 ms measured value interval) max. 600798 values										
Current consumption		without background illumination: approx. 1.3 mA with background illumination: approx. 16 mA (depending on adjusted intensity) standby mode: approx. 1.2 $\mu$ A										
Supply		3x 1.5 V: Duracell Plus battery, DUR087033, AA (LR6)										
Ingress protection		IP 67										
Mounting position <sup>2</sup>		any										
Weight		approx. 680 g										
A / D-converter resolution		16 bit (module)										
Battery life		standard use: > 2.000 h      standby mode: at least 5 years (with measurement rate 1/s and 2/s)										
Operational life		100 million load cycles										
CE-conformity		EMC directive: 2014/30/EU pressure equipment directive: 2014/68/EU (Module A) <sup>3</sup> electromagnetic compatibility: according to EN 61326										
<sup>2</sup> Pressure transmitters are calibrated in a vertical position with the pressure connection down. If this position is changed on installation there can be slight deviations in the zero point for pressure ranges $p_N \leq 1$ bar.												
<sup>3</sup> This directive is only valid for devices with maximum permissible overpressure > 200 bar.												

Dimensions (in mm)

standard

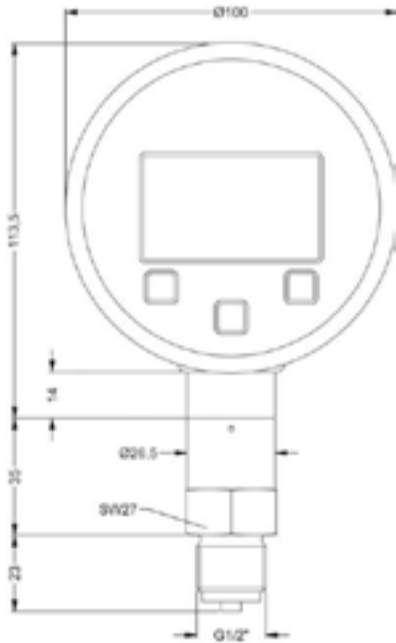

G1/2" EN 837

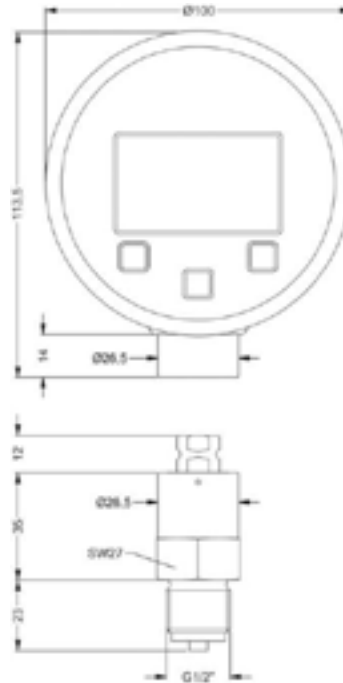

G1/2" EN 837  
(pressure transmitter and display separated)

optional

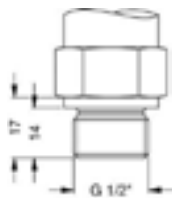

G1/2" DIN 3852

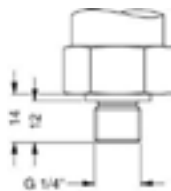

G1/4" DIN 3852

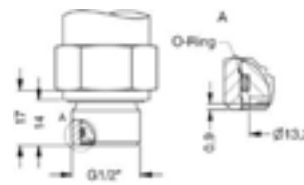

G1/2" DIN 3852  
with flush sensor <sup>4</sup>

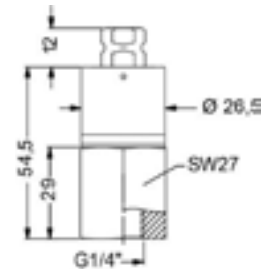

G1/4" EN 837  
internal thread, welded <sup>4,5</sup>

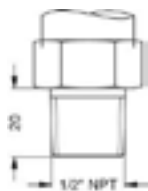

1/2" NPT

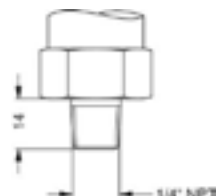

1/4" NPT

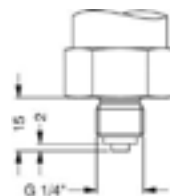

G 1/4" EN 837

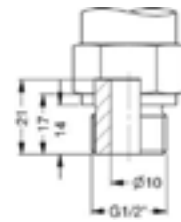

G1/2" DIN 3852  
open pressure port <sup>4</sup>

⇒ metrical threads and other variations on request

<sup>4</sup> only possible for nominal pressure ranges  $p_N \leq 40$  bar

<sup>5</sup> different connection versions with optional adapters possible (see accessories)



**Accessories are not in scope of supply and have to be ordered separately.**

**Software BD|LOG lite version (Communication, Configuration)**

Optionally the software BD|LOG and an interface cable can be ordered. The software is also available for download on our homepage.

**Software (Communication, Configuration):**

- display of device information (serial number, pressure and temperature range, ...)
- configuration area for all parameters
- download area for recorded data:
  - date
  - pressure value
  - temperature value
- actual value

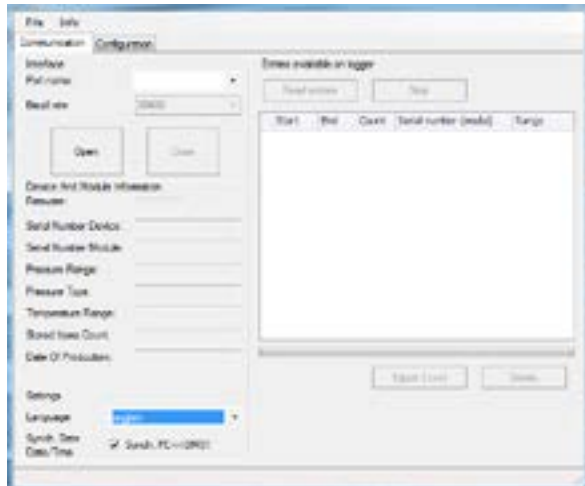

Interface cable with integrated USB converter  
l: 1.7 m

Ordering number: ZUSBCD02

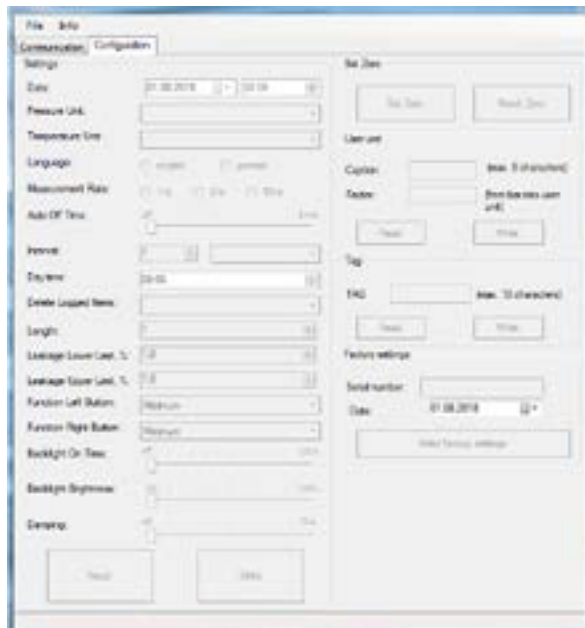

⇒ **Software BD|LOG full version (communication, configuration, table, diagram) on request**

**Adapter for pressure sensor module DL 01, pressure port G 1/4" EN 837 internal thread, welded**

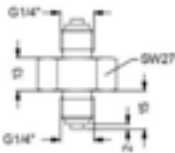
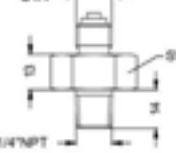
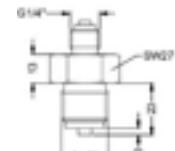
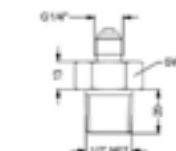
<p>G 1/4" EN 837</p>  <p>Ordering number: Z5010203</p>	<p>Adapter for pressure sensor module with pressure port G 1/4" EN 837 internal thread, welded</p> <p>external thread: G 1/4" EN 837 external thread: G 1/4" EN 837</p>	<p>1/4" NPT</p>  <p>Ordering number: Z5010204</p>	<p>Adapter for pressure sensor module with pressure port G 1/4" EN 837 internal thread, welded</p> <p>external thread: G 1/4" EN 837 external thread: 1/4" NPT</p>
<p>G 1/2" EN 837</p>  <p>Ordering number: Z5010202</p>	<p>Adapter for pressure sensor module with pressure port G 1/4" EN 837 internal thread, welded</p> <p>external thread: G 1/4" EN 837 external thread: G 1/2" EN 837</p>	<p>1/2" NPT</p>  <p>Ordering number: Z5010205</p>	<p>Adapter for pressure sensor module with pressure port G 1/4" EN 837 internal thread, welded</p> <p>external thread: G 1/4" EN 837 external thread: 1/2" NPT</p>

\* others on request

<p>Hard-shell service case without accessories</p> <p>Service_Case_DM01</p>		<p>Hard shell case.</p> <p>Dimension in mm (L x W x H): 432 X 363 X 138</p>
<p>Protective cap</p> <p>Ordering number: Z1002648</p>		<p>Rubber protection</p>
<p>Additional batteries (only in combination with service case)</p>		<p>for IS-version use only</p> <ul style="list-style-type: none"> <li>• 3 x 1.5 V / AA Duracell Power Plus</li> </ul>
<p>Seal set (only in combination with service case)</p>		<p>Flat seal copper for mechanical connections according to EN 837</p>
<p>PTFE seal tape Nr. 498.505 (only in combination with service case)</p>		<p>Seal tape for mechanical connections material: PTFE (Teflon) Temperature range: -200 ... 280 °C</p>
<p>Wrench (only in combination with service case)</p>		<p>Wrench SW 27</p>
<p>Calibration test pump KHP 35</p> <p>Ordering number: 1002637</p>		<p>The KHP 35 calibration test pump is used to generate pressure and vacuum for checking, adjusting and calibrating mechanical and electronic pressure measuring instruments by comparative measurements. These pressure tests may be carried out in laboratories, workshop or on site at the measuring point.</p> <p>pressure: 0 ... 35 bar vacuum: 0 ... -0,95 bar weight: ca. 510 g dimension: ca. 220 x 105 x 63 mm</p>
<b>Adapter for calibration test pump</b>		
<p>Test unit connection:</p> <p>Adapter to connect the test unit to the calibration test pump.</p>		<p>Adapter to connect the test unit to the calibration test pump.</p> <p>external thread: G ¼" EN 837</p> <p>to:</p> <p>internal thread: G ¼" DIN 3852 (No. 5008909) or G ½" EN o. DIN (No. 5007896) or ¼" NPT (No. 5007897) or ½" NPT (No. 5007898)</p> <p>others on request</p>
<p>Reference unit connection:</p> <p>Adapter to connect the digital gauge to the calibration test pump</p>		<p>Adapter to connect the pressure sensor module to the calibration test pump.</p> <p>external thread: G ½" EN 837</p> <p>to:</p> <p>internal thread: G ¼" DIN 3852 (No. 5012498) or G ½" DIN 3852 (No. 5012519) or ¼" NPT (No. 5012499) or ½" NPT (No. 5012500)</p> <p>others on request</p>



## Accessories DL 01

Accessories		
USB converter (incl. software BD LOG)		ZUSBCD02
service case (without accessories)		Service_Case_DM01
Protective cap		Z1002648
Additional batteries (3 x 1,5 V / AA Duracell Power Plus) <sup>4</sup>		1002798
Seal set <sup>4</sup>		5008886
PTFE seal tape <sup>4</sup>		1002724
wrench <sup>4</sup>		1002722
Calibration test pump (KHP)		1002637
Adapter for DL 01		
G1/4" EN 837 male - G1/4" EN 837 male		Z5010203
G1/4" EN 837 male - G1/2" EN 837 male		Z5010202
G1/4" EN 837 male - 1/4" NPT male		Z5010204
G1/4" EN 837 male - 1/2" NPT male		Z5010205
Adapter for KHP - test unit connection		
G1/4" EN 837 m - G1/4" DIN3852 fm		5008909
G1/4" EN 837 m - G1/2" EN 837/DIN3852 fm		5007896
G1/4" EN 837 m - 1/4" NPT fm		5007897
G1/4" EN 837 m - 1/2" NPT fm		5007898
Adapter for KHP - reference unit connection		
G1/2" EN 837 m - G1/4" DIN3852 fm		5012498
G1/2" EN 837 m - G1/2" DIN3852 fm		5012519
G1/2" EN 837 m - 1/4" NPT fm		5012499
G1/2" EN 837 m - 1/2" NPT fm		5012500

<sup>4</sup> only in combination with service case



# BAROLI 02

## Battery Powered Digital Pressure Gauge

Stainless Steel Sensor

class 0.1

### Nominal pressure

from 0 ... 100 mbar up to 0 ... 600 bar

### Special characteristics

- ▶ rotatable housing
- ▶ 2-line LC display  
4.5-digit 7-segment display  
6-digit 14-segment additional display

### Functions

- ▶ min / max function with reset function
- ▶ offset and end point calibration
- ▶ setting the pressure unit  
(bar, mbar, psi, InHg, cmHg, mmHg, hPa, kPa, MPa, mH<sub>2</sub>O, InH<sub>2</sub>O)
- ▶ switch-off automatic

The battery-powered digital pressure gauge BAROLI 02 enables a local displaying of values, satisfying the highest demands for accuracy and long-term stability. The pressure gauge may be applied in all media compatible with the stainless steel used; it shows an excellent robustness and a high overpressure protection.

The BAROLI 02 display housing is rotatable, thus ensuring an easy reading even under unfavourable mounting conditions.

Additional functions:

changing the unit, displaying min / max values, calibrating of offset and the span, configuring the automatic switching-off

### Preferred areas of use are



Plant and machine engineering  
Pneumatics / hydraulics  
Measurement technology  
Calibration and test purposes



Laboratory techniques



Environmental engineering  
(water – sewage – recycling)





Input pressure ranges											
Nominal pressure gauge [bar]	0.10	0.16	0.25	0.40	0.60	1	1.6	2.5	4	6	
Nominal pressure abs. [bar]	-	-	-	0.40	0.60	1	1.6	2.5	4	6	
Overpressure [bar]	0.5	1	1	2	5	5	10	10	20	40	
Burst pressure [bar]	1.5	1.5	1.5	3	7.5	7.5	15	15	25	50	
Nominal pressure gauge / abs. [bar]	10	16	25	40	60	100	160	250	400	600	
Overpressure [bar]	40	80	80	105	105	210	600	1050	1050	1250	
Burst pressure [bar]	50	120	120	210	210	420	1000	1250	1250	1250	
Vacuum pressure	-1 ... 0 bar, overpressure: 5 bar, burst pressure: 7.5 bar other vacuum ranges on request										
Vacuum resistance	$P_N \geq 1$ bar: unlimited vacuum resistance; $P_N < 1$ bar: on request										

Performance	
Accuracy <sup>1</sup>	nominal pressure $\geq 0.4$ bar: $\leq \pm 0.125$ % FSO BFSL nominal pressure $< 0.4$ bar: $\leq \pm 0.25$ % FSO BFSL
Measuring rate	5/sec
Long term stability	$\leq \pm 0.1$ % FSO / year at reference conditions

<sup>1</sup> accuracy according to IEC 60770 – minimum value setting (non-linearity, hysteresis, repeatability)

Thermal effects (Offset and Span)			
Nominal pressure $P_N$ [bar]	-1 ... 0	$\leq 0.40$	$> 0.40$
Tolerance band [% FS]	$\leq \pm 0.75$	$\leq \pm 1$	$\leq \pm 0.75$
in compensated range [°C]	-20 ... 85 °C	0 ... 70 °C	-20 ... 85 °C

Permissible temperatures			
Permissible temperatures	medium: -20 ... 85 °C	environment: -20 ... 70 °C	storage: -30 ... 80 °C

Mechanical stability	
Vibration	5 g RMS (25 ... 2000 Hz) according to DIN EN 60068-2-6
Shock	100 g / 1 msec according to DIN EN 60068-2-27

Materials	
Pressure port / Housing	stainless steel 1.4404 (316 L)
Display housing	PA 6.6, polycarbonate
Seals (media wetted)	FKM
Diaphragm	stainless steel 1.4435 (316 L)
Media wetted parts	pressure port, seals, diaphragm

Miscellaneous	
Display	LC display, visible range 40 x 30 mm; 4.5-digit 7-segment-display, digit height 11 mm, range of indication $\pm 19999$ ; 6-digit 14-segment additional display, digit height 7.5 mm
Electromagnetic compatibility	emission and immunity according to EN 61326
Supply	3.6 V Lithium battery; 2 pieces (type 1/2 AA)
Data storage	EEPROM (non-volatile)
Ingress protection	IP 65
Installation position	any <sup>2</sup>
Weight	approx. 300 g
AD-converter solution	14 Bit
Operational life of battery	standby mode: approx. 5 years
Mech. operational life	100 million load cycles
CE-conformity	EMC Directive: 2014/30/EU Pressure Equipment Directive: 2014/68/EU (Modul A) <sup>3</sup>

<sup>2</sup> The digital pressure gauge is calibrated in a vertical position with the pressure connection down. If this position is changed on installation there can be slight deviations in the zero point for devices with stainless steel sensor and pressure range  $P_N \leq 1$  bar.  
<sup>3</sup> This directive is only valid for devices with maximum permissible overpressure  $> 200$  bar.

**Dimensions (in mm)**

⇒ for nominal pressure  $P_N > 60$  bar increases the length of devices by 9 mm!





# BAROLI 02P

## Battery Powered Digital Pressure Gauge

Stainless Steel Diaphragm  
Flush Welded

class 0.1

### Nominal pressure

---

from 0 ... 100 mbar up to 0 ... 40 bar

### Special characteristics

---

- ▶ rotatable housing
- ▶ 2-line LC display  
4.5-digit 7-segment display  
6-digit 14-segment additional display
- ▶ hygienic process connections

### Functions

---

- ▶ min / max function with reset function
- ▶ offset and end point calibration
- ▶ setting the pressure unit
- ▶ configuration of switch-off automatic

The battery-powered digital pressure gauge BAROLI 02P with flush welded stainless steel sensor enables a local displaying of values in applications, where high requirements on hygienic process connections and easy cleaning or sterilization are requested. The filling medium is food compatible oil with FDA approval.

The BAROLI 02P display housing is rotatable, thus ensuring an easy reading even under unfavourable mounting conditions.

#### Additional functions:

switching the unit, displaying min / max values, calibrating the offset and the end point, configuring the automatic switching-off

### Preferred areas of use are

---



Food industry



Pharmacy



Input pressure ranges <sup>1</sup>									
Nominal pressure gauge	[bar]	-1 ... 0	0.10	0.16	0.25	0.40	0.60	1	1.6
Nominal pressure absolute	[bar]	-	-	-	-	0.40	0.60	1	1.6
Overpressure	[bar]	5	0.5	1	1	2	5	5	10
Burst pressure ≥	[bar]	7.5	1.5	1.5	1.5	3	7.5	7.5	15
Nominal pressure gauge / absolute	[bar]	2.5	4	6	10	16	25	40	
Overpressure	[bar]	10	20	40	40	80	80	105	
Burst pressure ≥	[bar]	15	25	50	50	120	120	210	
Vacuum resistance		p <sub>N</sub> ≥ 1 bar: unlimited vacuum resistance p <sub>N</sub> < 1 bar: on request							
<sup>1</sup> consider the pressure resistance of fitting and clamps									
Performance									
Accuracy <sup>2</sup>		nominal pressure ≥ 0.4 bar : ≤ ± 0.125 % BFSL nominal pressure < 0.4 bar: ≤ ± 0.25 % BFSL							
Measuring rate		5/sec							
<sup>2</sup> accuracy according to IEC 60770 – minimum value setting (non-linearity, hysteresis, repeatability)									
Thermal effects (offset and span)									
Nominal pressure p <sub>N</sub>	[bar]	-1 ... 0			< 0.40			≥ 0.40	
Tolerance band	[% FSO]	≤ ± 0.75			≤ ± 1.5			≤ ± 0.75	
in compensated range	[°C]	0 ... 70 °C			0 ... 50 °C			0 ... 70 °C	
Permissible temperatures									
Medium <sup>3</sup>		filling fluid of silicone oil: -40 ... 125 °C			filling fluid of food compatible oil: -10 ... 125 °C				
Environment		-20 ... 70 °C							
Storage		-30 ... 80 °C							
<sup>3</sup> max temperature of the medium for nominal pressure gauge > 0 bar: 150 °C for 60 minutes with a max. environmental temperature of 50 °C									
Mechanical stability									
Vibration		5 g RMS (25 ... 2000 Hz)				according to IEC 60068-2-6			
Shock		100 g / 1 msec				according to IEC 60068-2-27			
Materials / Filling fluids									
Housing		stainless steel 1.4404 (316 L)							
Pressure port		stainless steel 1.4435 (316 L)				other on request			
Display housing		PA 6.6, polycarbonate							
Seals (media wetted)		standard: FKM		clamp and dairy pipe: none					
Diaphragm		stainless steel 1.4435 (316 L)							
Media wetted parts		pressure port, seals, diaphragm							
Filling fluids		standard: silicone oil		option: food compatible oil with FDA-certificate (mobile SHC Cibus 32; class code: H1; NFS registration no.: 141500) other on request					
Miscellaneous									
EHDG certificate Type EL Class I		EHDG conformity is only ensured in combination with an approved seal. This is e.g. for - Clamp (C62): T-ring-seal from Combifit International B.V. - dairy pipe (M73): ASEPTO-STAR k-flex upgrade seal by Kieselmann GmbH							
Display		LC display, visible range 40 x 30 mm; 4.5-digit 7-segment-display, digit height 11 mm, range of indication ±19999; 6-digit 14-segment additional display, digit height 7.5 mm							
Electromagnetic compatibility		emission and immunity according to EN 61326							
Supply		3.6 V Lithium battery; 2 pieces (type 1/2 AA)							
Data storage		EEPROM (non-volatile)							
Ingress protection		IP 65							
Installation position		any (standard: the device is calibrated in a vertical position with the pressure connection down; other than the given position for p <sub>N</sub> ≤ 2 bar have to be declared at ordering)							
Weight		min. 350 g (pendent on the pressure connection)							
AD-converter solution		14 Bit							
Operational life of battery		standby mode: approx. 5 years							
Mech. operational life		100 million load cycles							
CE-conformity		EMV Directive: 2014/30/EU							

### Dimensions (in mm)

#### standard

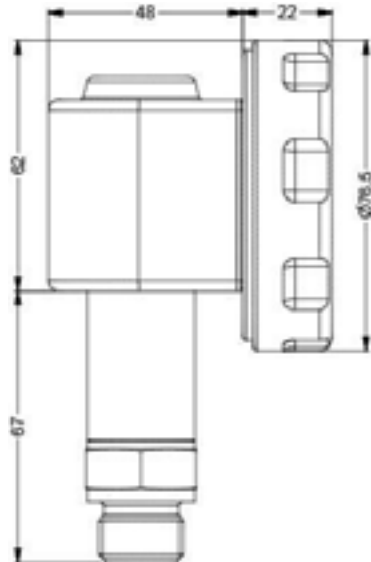

G1/2" flush DIN 3852  
 $p_N \geq 1$  bar

#### option

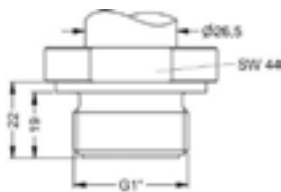

G1" flush DIN 3852

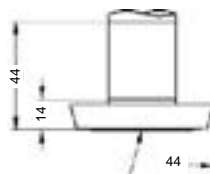

flush diaphragm  $\varnothing 23$

dairy pipe DN25 DIN 11851  
 $(p_N \geq 0.25$  bar)



flush diaphragm  $\varnothing 32$

clamp 1 1/2" ISO 2852  
 $(p_N \leq 16$  bar)



## Ordering code BAROLI 02P

## BAROLI 02P

□	□	□	-	□	□	□	-	0	-	□	□	□	□	□	□	□	□	□	□	□	□	□	□
---	---	---	---	---	---	---	---	---	---	---	---	---	---	---	---	---	---	---	---	---	---	---	---

Pressure		gauge	M	0	G																			
absolute <sup>1</sup>			M	0	H																			
<b>Input</b>	[bar]																							
	0.10 <sup>1</sup>		1	0	0	0																		
	0.16 <sup>1</sup>		1	6	0	0																		
	0.25 <sup>1</sup>		2	5	0	0																		
	0.40		4	0	0	0																		
	0.60		6	0	0	0																		
	1.0		1	0	0	1																		
	1.6		1	6	0	1																		
	2.5		2	5	0	1																		
	4.0		4	0	0	1																		
	6.0		6	0	0	1																		
	10		1	0	0	2																		
	16		1	6	0	2																		
	25		2	5	0	2																		
	40		4	0	0	2																		
-1 ... 0		X	1	0	2																			
customer		9	9	9	9																	consult		
<b>Accuracy</b>	[BFSL]																							
standard for $P_N \geq 0.4$ bar	0.125 %							B	2															
standard for $P_N < 0.4$ bar	0.25 %							B	5															
customer								9	9													consult		
<b>Mechanical connection</b>																								
G1/2" DIN 3852 with flush diaphragm <sup>2</sup>								Z	0	0														
G1" DIN 3852 with flush diaphragm								Z	3	1														
Clamp 1 1/2" <sup>3</sup>								C	6	2														
Dairy pipe DN 25 (DIN 11851) <sup>4</sup>								M	7	3														
customer								9	9	9												consult		
<b>Seals</b>																								
for clamp or dairy pipe: without										0														
FKM										1														
customer										9												consult		
<b>Diaphragm</b>																								
Stainless steel 1.4435 (316L)										1														
customer										9												consult		
<b>Front foil</b>																								
standard																					1			
neutral																					N			
customer																					9	consult		
<b>Filling fluids</b>																								
Silicone oil																						1		
food compatible oil																						2		
customer																						9		
<b>Special version</b>																								
standard																						0 0 0		
customer																						9 9 9		
consult																								

<sup>1</sup> absolute pressure possible from 0.4 bar

<sup>2</sup> possible only for  $P_N \geq 1$  bar

<sup>3</sup> possible only for  $P_N \leq 16$  bar

<sup>4</sup> possible only for  $P_N \geq 0.25$  bar; cup nut for dairy pipe included and pre-assembled



# BAROLI 05

## Battery Powered Digital Pressure Gauge

Ceramic Sensor

class 0.2

### Nominal pressure

from 0 ... 400 mbar up to 0 ... 600 bar

### Special characteristics

- ▶ rotatable housing
- ▶ 2-line LC display  
4.5-digit 7-segment display  
6-digit 14-segment additional display
- ▶ different mechanical connections:  
inch, NPT threads



### Functions

- ▶ min / max function with reset function
- ▶ offset and end point calibration
- ▶ setting the pressure unit  
(bar, mbar, psi, InHg, cmHg, mmHg,  
hPa, kPa, MPa, mH<sub>2</sub>O, InH<sub>2</sub>O)
- ▶ switch-off automatic configuration

The battery-powered digital pressure gauge BAROLI 05 has been designed for measuring the pressure (absolute or gauge) of fluids, oils and gases.

The display housing is rotatable, thus ensuring an easy reading even under unfavourable mounting conditions. Additional functions as changing unit, displaying min / max values, calibrating the offset and of span, as well as configuring the automatic switching-off complete the profile.

### Preferred areas of use are

-  Plant and machine engineering  
Pneumatics / hydraulics
-  Laboratory techniques
-  Environmental engineering  
(water - sewage - recycling)



Input pressure range																	
Nominal pressure gauge [bar]	0.4	0.6	1	1.6	2.5	4	6	10	16	25	40	60	100	160	250	400	600
Nominal pressure abs. [bar]	-	0.6	1	1.6	2.5	4	6	10	16	25	40	60	100	160	250	400	600
Overpressure [bar]	1	2	2	4	4	10	10	20	40	40	100	100	200	400	400	600	800
Burst pressure [bar]	2	4	4	5	5	12	12	25	50	50	120	120	250	500	500	650	880
Vacuum pressure	-1 ... 0 bar, overpressure: 4 bar, burst pressure: 7 bar																
Vacuum resistance	P <sub>N</sub> ≥ 1 bar: unlimited vacuum resistance P <sub>N</sub> < 1 bar: on request																

Performance	
Accuracy <sup>1</sup>	≤ ± 0.25 % FSO BFSL
Measuring rate	5/sec
<sup>1</sup> accuracy according to IEC 60770 – minimum value setting (non-linearity, hysteresis, repeatability)	
Thermal effects (Offset and Span)	
Thermal effects	≤ ± 0.2 % FSO / 10 K in compensated range 0 ... 85 °C
Permissible temperatures	
Permissible temperatures	medium: -20 ... 85 °C environment: -20 ... 70 °C storage: -30 ... 80 °C
Mechanical stability	
Vibration	5 g RMS (25 ... 2000 Hz) according to DIN EN 60068-2-6
Shock	100 g / 1 msec according to DIN EN 60068-2-27
Materials	
Pressure port / housing	stainless steel 1.4404 (316L)
Display housing	PA 6.6, Polycarbonate
Seals (media wetted)	FKM
Diaphragm	ceramics Al <sub>2</sub> O <sub>3</sub> 96 %
Media wetted parts	pressure port, seals, diaphragm
Miscellaneous	
Display	LC-Display, visible range 40 x 30 mm; 4.5-digit 7-segment main display, digit height 11 mm, range of indication ±19999; 6-digit 14-segment additional display, digit height 7.5 mm
Electromagnetic compatibility	emission and immunity according to EN 61326
Supply	3.6 V lithium battery; 2 pieces (1/2 AA)
Data storage	EEPROM (non-volatile)
Ingress protection	IP 65
Installation position	any
Weight	approx. 300 g
AD-converter solution	14 Bit
Operational life of battery	standby mode: approx. 5 years
Mechanical operational life	100 million load cycles
CE-conformity	EMC directive: 2014/30/EU pressure equipment directive: 2014/68/EU (module A) <sup>2</sup>

<sup>2</sup> This directive is only valid for devices with maximum permissible overpressure > 200 bar.

#### Dimensions (in mm)

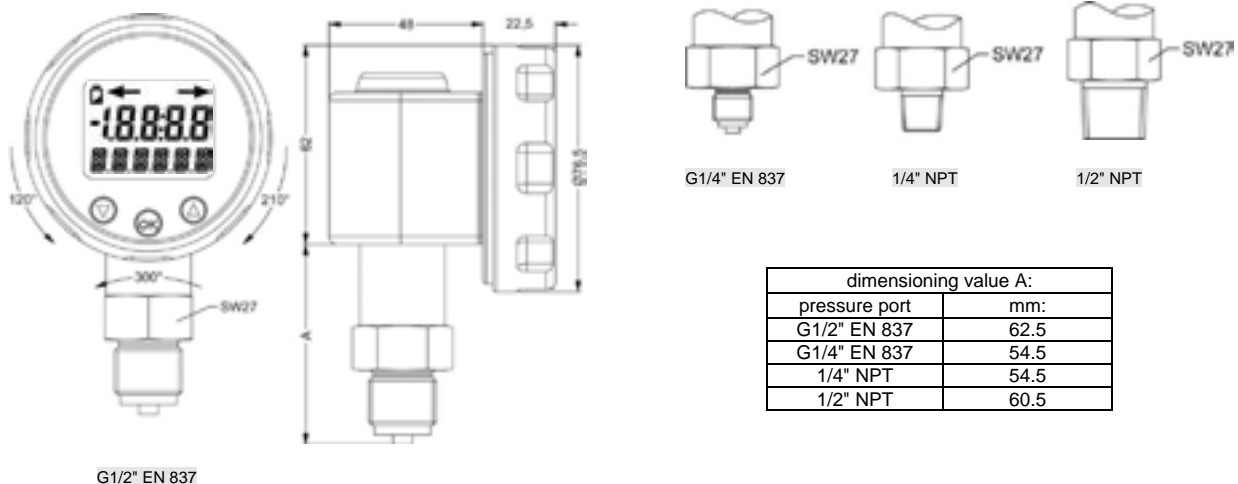

dimensioning value A:	
pressure port	mm:
G1/2" EN 837	62.5
G1/4" EN 837	54.5
1/4" NPT	54.5
1/2" NPT	60.5

### Ordering code BAROLI 05

BAROLI 05

□□□ - □□□□ - 0 - □□ - 0K0 - □□□ - □ - □ - □ - □□□

<b>Pressure</b>										
gauge	M	0	0							
absolute	M	0	1							
<b>Input [bar]</b>										
0,4		4	0	0	0					
0,6		6	0	0	0					
1.0		1	0	0	1					
1.6		1	6	0	1					
2.5		2	5	0	1					
4.0		4	0	0	1					
6.0		6	0	0	1					
10		1	0	0	2					
16		1	6	0	2					
25		2	5	0	2					
40		4	0	0	2					
60		6	0	0	2					
100		1	0	0	3					
160		1	6	0	3					
250		2	5	0	3					
400		4	0	0	3					
600		6	0	0	3					
-1 ... 0		X	1	0	2					
customer		9	9	9	9					consult
<b>Accuracy [BFSL]</b>										
0.25 %						B	5			
customer						9	9			consult
<b>Mechanical connection</b>										
G1/2" EN 837						2	0	0		
G1/4" EN 837						4	0	0		
1/2" NPT						N	0	0		
1/4" NPT						N	4	0		
customer						9	9	9		consult
<b>Seals</b>										
FKM								1		
customer								9		consult
<b>Pressure port</b>										
stainless steel 1.4404 (316L)								1		
customer								9		consult
<b>Diaphragm</b>										
ceramics Al <sub>2</sub> O <sub>3</sub> 96%								2		
customer								9		consult
<b>Front foil</b>										
standard									1	
neutral									N	
customer									9	consult
<b>Special version</b>										
standard									0	0
customer									9	9
										consult



# BAROLI 05P

## Battery Powered Digital Pressure Gauge

Stainless Steel Diaphragm Flush Welded

class 0.2

### Nominal pressure

from 0 ... 60 bar up to 0 ... 400 bar

### Product characteristics

- ▶ rotatable housing
- ▶ 2-line LC display  
4.5-digit 7-segment display  
6-digit 14-segment additional display
- ▶ for viscous and pasty media

### Functions

- ▶ min / max function with reset function
- ▶ offset and end point calibration
- ▶ setting the pressure unit
- ▶ switch-off automatic configuration

The battery-powered digital pressure gauge BAROLI 05P with flush welded stainless steel diaphragm enables a local displaying of values in applications, where high requirements on hygienic process connections and easy cleaning or sterilisability are requested. The filling medium is food compatible oil with FDA approval.

The BAROLI 05P display housing is rotatable, thus ensuring an easy reading even under unfavourable mounting conditions. Additional functions as changing unit, displaying min / max values, calibrating of offset and span, as well as configuring the automatic switching-off complete the profile.

### Preferred areas of use are





Plant and machine engineering



Food industry

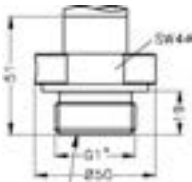

Input pressure range						
Nominal pressure gauge / abs.	[bar]	60	100	160	250	400
Overpressure	[bar]	100	200	400	400	600
Burst pressure $\geq$	[bar]	120	250	500	500	650
Performance						
Accuracy <sup>1</sup>		$\leq \pm 0.25\%$ FSO BFSL				
Measuring rate		5/sec				
<sup>1</sup> accuracy according to IEC 60770 – minimum value setting (non-linearity, hysteresis, repeatability)						
Thermal effects (Offset and Span)						
Tolerance band	[% FS]	$\leq \pm 0.2\%$ FSO / 10 K				
In compensated range	[°C]	0 ... 70				
Permissible temperatures <sup>2</sup>		medium: -40 ... 125 °C for filling fluid silicon oil -10 ... 125 °C for filling fluid food compatible oil environment: -20 ... 70 °C storage: -30 ... 80 °C				
<sup>2</sup> max temperature of the medium for nominal pressure gauge > 0 bar: 150 °C for 60 minutes with a max. environmental temperature of 50 °C						
Mechanical stability						
Vibration		5 g RMS (25 ... 2000 Hz)	according to IEC 60068-2-6			
Shock		100 g / 1 msec	according to IEC 60068-2-27			
Materials / Filling fluids						
Housing		stainless steel 1.4404 (316L)				
Pressure port		stainless steel 1.4435 (316L)				
Display housing		PA 6.6, Polycarbonate				
Seals (media wetted)		FKM				
Diaphragm		stainless steel 1.4435 (316L)				
Media wetted parts		pressure port, seals, diaphragm				
Filling fluids		standard: silicone oil option: food compatible oil with FDA approval (Mobil SCH Cibus 32; Category Code: H1; NSF Registration No.: 141500) others on request				
Miscellaneous						
Display		LC-Display, visible range 40 x 30 mm; 4.5-digit 7-segment main display, digit height 11 mm, range of indication $\pm 1999$ ; 6-digit 14-segment additional display, digit height 7.5 mm				
Electromagnetic compatibility		emission and immunity according to EN 61326				
Supply		3.6 V lithium battery; 2 pieces (1/2 AA)				
Data storage		EEPROM (non-volatile)				
Ingress protection		IP 65				
Installation position		any (standard calibrating in a vertical position with the pressure connection down)				
Weight		min. 350 g (depending on pressure port)				
AD-converter solution		14 bit				
Operational life of battery		standby mode: approx. 5 years				
Mechanical operational life		100 million load cycles				
CE-conformity		EMC directive: 2014/30/EU		pressure equipment directive: 2014/68/EU (module A) <sup>3</sup>		
<sup>3</sup> This directive is only valid for devices with maximum permissible overpressure > 200 bar.						
Dimensions (in mm)						
standard			option			
						
G1/2" flush (DIN 3852)		flush diaphragm $\varnothing 18$		flush diaphragm $\varnothing 28$		
				G1" flush (DIN 3852)		

# BAROLI 05P

Ordering Code

## Ordering code BAROLI 05P

BAROLI 05P

□	□	□	-	□	□	□	-	0	-	□	-	0	K	0	-	□	□	-	□	-	□	-	□	□	□
---	---	---	---	---	---	---	---	---	---	---	---	---	---	---	---	---	---	---	---	---	---	---	---	---	---

Pressure	
gauge	M 0 5
absolute	M 0 6
Input [bar]	
60	6 0 0 2
100	1 0 0 3
160	1 6 0 3
250	2 5 0 3
400	4 0 0 3
customer	9 9 9 9
Accuracy [BFSL]	
0.25 %	B 5
customer	9 9
Mechanical connection	
G1/2" with flush welded diaphragm (DIN 3852)	Z 0 0
G1" with flush welded diaphragm (DIN 3852)	Z 3 1
customer	9 9 9
Seals	
FKM	1
customer	9
Diaphragm	
stainless steel 1.4435 (316L)	1
customer	9
Front foil	
standard	1
neutral	N
customer	9
Filling fluids	
silicone oil	1
food compatible oil	2
customer	9
Special version	
standard	0 0 0
customer	9 9 9





# DM 10

## Battery Powered Digital Pressure Gauge

Ceramic Sensor

class 0.5

### Nominal pressure

from 0 ... 1.6 bar up to 0 ... 250 bar

### Special characteristics

- ▶ rotatable housing and display
- ▶ LC display  
4.5-digit 7-segment display
- ▶ standard battery CR 2450  
operation period > 1 500 h

### Functions

- ▶ min / max function with reset function
- ▶ auto-zero
- ▶ setting of pressure unit  
(bar, mbar, psi, MPa, mH<sub>2</sub>O)
- ▶ configuration of switch-off automatic

The compact low-cost digital pressure gauge DM 10 is battery-powered and has an adjustable housing; it is thus extremely suitable for mobile pressure monitoring. The 4.5-digit LC-display indicates the battery status, the measurement value as well as the unit, this enables a fast and precise reading.

It is possible to switch between the most common units (bar, psi, Pa, MPa). Additional functions as auto-zero, min / max values and an automatic switching-off complete the DM 10 profile.

### Preferred areas of use are



Mobile pressure monitoring  
Plant and machine engineering  
Pneumatics / hydraulics



Environmental engineering  
(water – sewage – recycling)



Input Pressure													
Nominal pressure gauge [bar]		1.6	2.5	4	6	10	16	25	40	60	100	160	250
Overpressure [bar]		4	4	10	10	20	40	40	100	100	200	400	400
Burst pressure [bar]		7	7	15	15	35	70	70	150	150	250	450	450
Vacuum resistance		unlimited											

Performance	
Accuracy <sup>1</sup>	$\leq \pm 0.5\%$ FSO BFSL
Measuring rate	1/sec
Long term stability	$\leq \pm 0.3\%$ FSO / year
<sup>1</sup> accuracy according to IEC 60770 – minimum value setting (non-linearity, hysteresis, repeatability)	
Thermal effects (Offset and Span)	
Tolerance band	$\leq \pm 0.5\%$ FSO / 10 K (typ.) in compensated range 0 ... 50 °C
Permissible temperatures	
Permissible temperatures	medium: -25 ... 85 °C environment: 0 ... 70 °C storage: 0 ... 70 °C
Materials	
Pressure port / housing	stainless steel 1.4301 (304)
Display housing	PA 6.6, Polycarbonate
Seals (media wetted)	FKM others on request
Diaphragm	ceramics Al <sub>2</sub> O <sub>3</sub> 96 %
Media wetted parts	pressure port, seals, diaphragm
Miscellaneous	
Display	LC-Display, visible range 36 x 15 mm; 4.5-digit 7-segment-display, digit size 8.5 mm, range of indication $\pm 1999$ decimal place is calculated automatically by device considering range and accuracy - customer-setting not possible
Electromagnetic compatibility	emission and immunity according to EN 61326
Supply	3 V lithium battery (CR 2450)
Data storage	EEPROM (non-volatile)
Ingress protection	IP 65
Installation position	any
Weight	approx. 150 g
Operational life of battery	min. 1 500 h with permanent operation
Mech. operational life	100 million load cycles
CE-conformity	EMC directive 2014/30/EU pressure equipment directive: 2014/68/EU (Modul A) <sup>2</sup>

<sup>2</sup> This directive is only valid for devices with maximum permissible overpressure > 200 bar.

#### Dimensions (in mm)

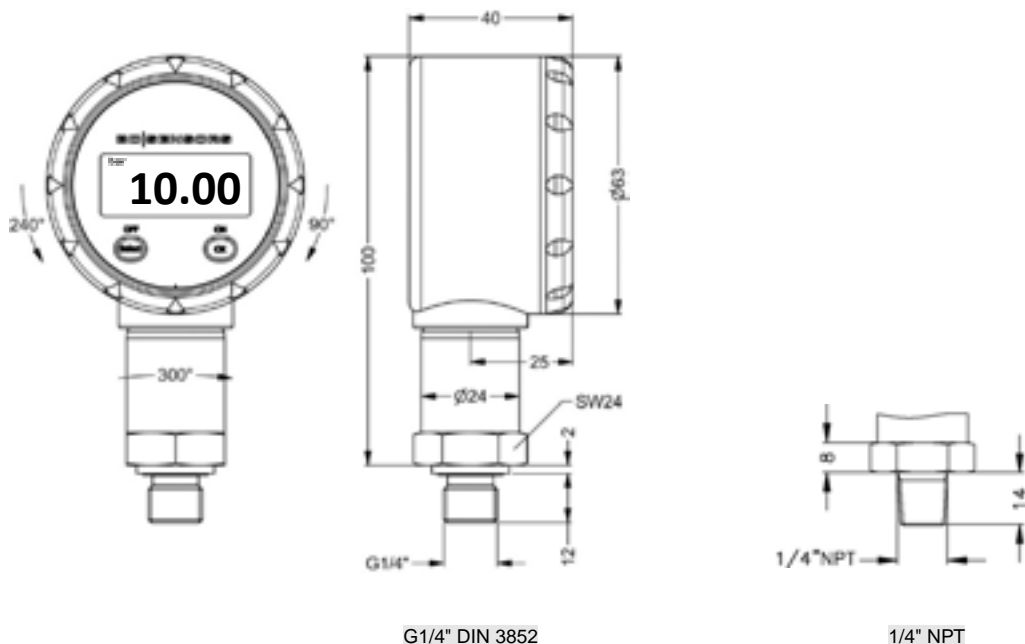

Ordering code DM 10

DM 10

□□□ - □□□ - 0 - □□ - 0K0 - □□□ - □ - □ - □ - □ - □□

<b>Pressure</b>	gauge	M 0 4																		
<b>Input</b>	[bar]																			
	1.6		1	6	0	1														
	2.5		2	5	0	1														
	4.0		4	0	0	1														
	6.0		6	0	0	1														
	10		1	0	0	2														
	16		1	6	0	2														
	25		2	5	0	2														
	40		4	0	0	2														
	60		6	0	0	2														
	100		1	0	0	3														
	160		1	6	0	3														
	250		2	5	0	3														
	customer		9	9	9	9														consult
<b>Accuracy</b>	[BFSL]																			
	0.5 %						B	8												
	customer						9	9												consult
<b>Mechanical connection</b>																				
	G1/4" DIN 3852								3	0	0									
	1/4" NPT								N	4	0									
	customer								9	9	9									consult
<b>Seals</b>																				
	FKM										1									
	customer										9									consult
<b>Pressure port</b>																				
	Stainless steel 1.4301 (304)											2								
	customer											9								consult
<b>Diaphragm</b>																				
	Ceramics Al <sub>2</sub> O <sub>3</sub> 96%												2							
	customer												9							consult
<b>Front foil</b>																				
	standard																			1
	neutral																			N
	customer																			9
<b>Special version</b>																				
	standard																			0 0 0
	customer																			9 9 9



# DM 17

## Battery Powered Digital Pressure Gauge

stainless steel sensor, welded

class 0.5

### Nominal pressure

---

from 0 ... 6 bar up to 0 ... 600 bar

### Special characteristics

---

- ▶ rotatable housing and display
- ▶ LC display  
4.5-digit 7-segment display
- ▶ standard battery CR 2450  
operation period > 1 500 h

### Functions

---

- ▶ min / max function with reset function
- ▶ auto-zero
- ▶ setting of pressure unit  
(bar, mbar, psi, MPa, mH<sub>2</sub>O)
- ▶ configuration of automatic switch-off

### Option

---

- ▶ oil and grease free version  
for oxygen application

The compact digital pressure gauge DM 17 is characterized by its long-lasting battery supply as well as its adjustable housing. Thus, the DM 17 is ideal for mobile pressure monitoring. An unusual feature of the DM 17 is the welded pressure sensor. An absolute use in oxygen applications is given and strictest requirements on the particle liberty are fulfilled.

The 4.5-digit LC-display indicates the battery status, the measurement value as well as the unit; this enables a fast and precise reading.

Additional functions like setting of pressure unit, auto-zero, min / max values and an automatic switching-off function.

### Preferred areas of use are

---



Mobile pressure monitoring  
Plant and machine engineering  
Pneumatics / hydraulics



Oxygen application



Input Pressure												
Nominal pressure gauge [bar]	6	10	16	25	40	60	100	160	250	400	600	
Overpressure [bar]	12	20	32	50	80	120	200	320	500	800	1 200	
Burst pressure [bar]	30	50	80	125	200	300	500	800	1 400	2 000	3 000	
Vacuum resistance	unlimited											

Performance	
Accuracy	≤ ± 0.5 % FSO BFSL
Measuring rate	1/sec
Long term stability	≤ ± 0.3 % FSO / year at reference conditions

Thermal effects (Offset and Span)	
Tolerance band	≤ ± 0.5 % FSO / 10 K (typ.) in compensated range 0 ... 50 °C

Permissible temperatures	
Permissible temperatures	medium: -25 ... 85 °C environment: 0 ... 70 °C storage: 0 ... 70 °C

Materials	
Pressure port / housing	stainless steel 1.4571 (316Ti) / 1.4301 (304)
Display housing	PA 6.6, Polycarbonate
Seal of sensor	none (welded)
Diaphragm	stainless steel 1.4542 (630)
Media wetted parts	pressure port, diaphragm

Miscellaneous	
Display	LC-Display, visible range 36 x 15 mm; 4.5-digit 7-segment-display, digit size 8.5 mm, range of indication ±1999 decimal place is calculated automatically by device considering range and accuracy - customer-setting not possible
Electromagnetic compatibility	emission and immunity according to EN 61326
Supply	3 V lithium battery (CR 2450)
Data storage	EEPROM (non-volatile)
Ingress protection	IP 65
Installation position	any
Weight	plastic: approx. 150 g
Operational life of battery	min. 1 500 h with permanent operation
Mech. operational life	100 million load cycles
CE-conformity	EMC directive 2014/30/EU pressure equipment directive: 2014/68/EU (Modul A) <sup>1</sup>

<sup>1</sup> This directive is only valid for devices with maximum permissible overpressure > 200 bar.

**Dimensions (in mm)**

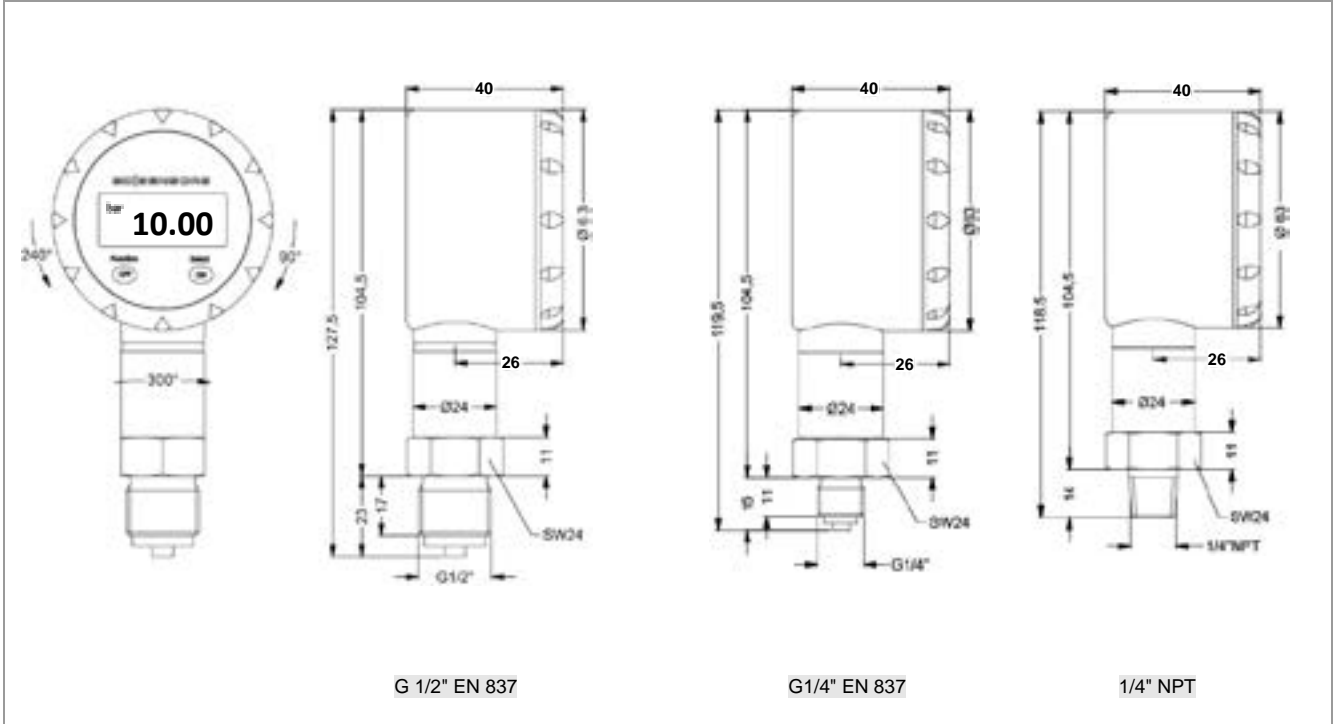







## COMPETENCE

Industrial pressure measurement technology from 0.1 mbar up to 6000 bar

- > pressure transmitters, electronic pressure switches or hydrostatic level probes
- > OEM or high-end products
- > standard products or customized solutions

BD|SENSORS has the right pressure measuring device at the right price.

## PRICE / PERFORMANCE

pressure measurement at the highest level

The concentration on electronic pressure transmitter has led to extraordinary efficiency and economical pricing.

BD|SENSORS is certain to be one of the most economical suppliers on the world market, given equal technical and commercial conditions.

## RELIABILITY

projectable delivery times and strict observance of deadlines

Short delivery times and firm deadlines, even for special designs, make BD|SENSORS a reliable partner for our customers.

BD|SENSORS reduces the level of your stock-keeping and increases your profitability.

## FLEXIBILITY

We have special solutions for your individual requirement.

We solve your problem in industrial pressure measurement quickly and economically, not only with large-scale production lines, but also for smaller requirements.

BD|SENSORS is especially flexible when technical support and quick assistance are required in service case as well as for rush orders.

## INDUSTRIES



plant and machine engineering



chemical and biochemical industry



energy industry



renewable energy



semiconductor industry /  
cleanroom technology



HVAC



hydraulics



refrigeration



calibration techniques



laboratory techniques



medical technology



food and beverage



vehicles and mobile hydraulics



oil and gas industry



pharmaceutical industry



marine / shipbuilding / offshore



heavy industry



environmental industry



packaging and paper industry

## MEDIA



sewage



aggressive media



colours



gases



fuels and oils



pasty and viscous media



oxygen



water



### **DISTRIBUTION WORLDWIDE**

HEADQUARTER DER BD | SENSORS GROUP

BD | SENSORS GmbH  
BD-Sensors-Straße 1  
95199 Thierstein  
GERMANY

Tel.: +49 9235 9811-0  
Fax: +49 9235 9811-11

[www.bdsensors.de](http://www.bdsensors.de)  
[info@bdsensors.de](mailto:info@bdsensors.de)



### **DISTRIBUTION RUSSIA**

BD | SENSORS Rus  
37a, Varshavskoe shosse  
117105 Moscow  
RUSSIA

Tel.: +420 572 411-011  
Fax: +420 572 411-497

[www.bdsensors.ru](http://www.bdsensors.ru)  
[sales@bdsensors.ru](mailto:sales@bdsensors.ru)

### **DISTRIBUTION EASTERN EUROPE**

BD | SENSORS s.r.o.  
Hradištská 817  
68708 Buchlovice  
CZECH REPUBLIC

Tel.: +420 572 411-011  
Fax: +420 572 411-497

[www.bdsensors.cz](http://www.bdsensors.cz)  
[sale@bdsensors.cz](mailto:sale@bdsensors.cz)

### **DISTRIBUTION CHINA**

BD | SENSORS China  
Building B, 2nd floor,  
Building 10, No. 1188, Lianhang Road  
Pujiang Town, Minhang District, Shanghai  
CHINA

Tel.: +86 21 51600190  
Fax: +86 21 33600610

[www.bdsensors-china.com](http://www.bdsensors-china.com)  
[info@bdsensors-china.com](mailto:info@bdsensors-china.com)