

Operating Instructions

Radar sensor for continuous level measurement of liquids

VEGAPULS 65

Two-wire 4 ... 20 mA/HART



Document ID: 36515



VEGA

Contents

1	About this document	4
1.1	Function	4
1.2	Target group	4
1.3	Symbols used.....	4
2	For your safety	5
2.1	Authorised personnel	5
2.2	Appropriate use.....	5
2.3	Warning about incorrect use.....	5
2.4	General safety instructions	5
2.5	EU conformity.....	6
2.6	NAMUR recommendations	6
2.7	Radio license for Europe	6
2.8	Radio license for USA	7
2.9	Installation and operation in the USA and Canada	7
2.10	Environmental instructions	7
3	Product description	8
3.1	Configuration.....	8
3.2	Principle of operation.....	9
3.3	Packaging, transport and storage.....	9
3.4	Accessories and replacement parts	10
4	Mounting	12
4.1	General instructions	12
4.2	Mounting instructions	13
5	Connecting to power supply	18
5.1	Preparing the connection	18
5.2	Connecting.....	19
5.3	Wiring plan, single chamber housing.....	20
5.4	Wiring plan, double chamber housing	21
5.5	Wiring plan, Ex-d-ia double chamber housing.....	23
5.6	Double chamber housing with VEGADIS-Adapter	24
5.7	Wiring plan - version IP 66/IP 68, 1 bar.....	25
5.8	Switch-on phase.....	25
6	Set up with the display and adjustment module	26
6.1	Insert display and adjustment module	26
6.2	Adjustment system	27
6.3	Measured value indication - Selection of national language	28
6.4	Parameter adjustment	29
6.5	Saving the parameterisation data	47
7	Setup with PACTware	48
7.1	Connect the PC.....	48
7.2	Parameter adjustment	48
7.3	Saving the parameterisation data	50
8	Set up with other systems	51
8.1	DD adjustment programs	51
8.2	Field Communicator 375, 475	51

9	Diagnosis, asset management and service	52
9.1	Maintenance	52
9.2	Measured value and event memory	52
9.3	Asset Management function.....	53
9.4	Rectify faults.....	56
9.5	Exchanging the electronics module.....	60
9.6	Software update	60
9.7	How to proceed if a repair is necessary.....	61
10	Dismount.....	62
10.1	Dismounting steps.....	62
10.2	Disposal	62
11	Supplement	63
11.1	Technical data	63
11.2	Dimensions	70
11.3	Industrial property rights.....	74
11.4	Trademark	74



Safety instructions for Ex areas

Take note of the Ex specific safety instructions for Ex applications. These instructions are attached as documents to each instrument with Ex approval and are part of the operating instructions.

Editing status: 2018-11-23

1 About this document

1.1 Function

This operating instructions provides all the information you need for mounting, connection and setup as well as important instructions for maintenance, fault rectification, the exchange of parts and the safety of the user. Please read this information before putting the instrument into operation and keep this manual accessible in the immediate vicinity of the device.

1.2 Target group

This operating instructions manual is directed to trained personnel. The contents of this manual must be made available to the qualified personnel and implemented.

1.3 Symbols used



Document ID

This symbol on the front page of this instruction refers to the Document ID. By entering the Document ID on www.vega.com you will reach the document download.



Information, tip, note

This symbol indicates helpful additional information.



Caution: If this warning is ignored, faults or malfunctions can result.
Warning: If this warning is ignored, injury to persons and/or serious damage to the instrument can result.



Danger: If this warning is ignored, serious injury to persons and/or destruction of the instrument can result.



Ex applications

This symbol indicates special instructions for Ex applications.



List

The dot set in front indicates a list with no implied sequence.



Action

This arrow indicates a single action.



Sequence of actions

Numbers set in front indicate successive steps in a procedure.



Battery disposal

This symbol indicates special information about the disposal of batteries and accumulators.

2 For your safety

2.1 Authorised personnel

All operations described in this documentation must be carried out only by trained, qualified personnel authorised by the plant operator.

During work on and with the device, the required personal protective equipment must always be worn.

2.2 Appropriate use

VEGAPULS 65 is a sensor for continuous level measurement.

You can find detailed information about the area of application in chapter "*Product description*".

Operational reliability is ensured only if the instrument is properly used according to the specifications in the operating instructions manual as well as possible supplementary instructions.

2.3 Warning about incorrect use

Inappropriate or incorrect use of this product can give rise to application-specific hazards, e.g. vessel overfill through incorrect mounting or adjustment. Damage to property and persons or environmental contamination can result. Also, the protective characteristics of the instrument can be impaired.

2.4 General safety instructions

This is a state-of-the-art instrument complying with all prevailing regulations and directives. The instrument must only be operated in a technically flawless and reliable condition. The operator is responsible for the trouble-free operation of the instrument. When measuring aggressive or corrosive media that can cause a dangerous situation if the instrument malfunctions, the operator has to implement suitable measures to make sure the instrument is functioning properly.

During the entire duration of use, the user is obliged to determine the compliance of the necessary occupational safety measures with the current valid rules and regulations and also take note of new regulations.

The safety instructions in this operating instructions manual, the national installation standards as well as the valid safety regulations and accident prevention rules must be observed by the user.

For safety and warranty reasons, any invasive work on the device beyond that described in the operating instructions manual may be carried out only by personnel authorised by the manufacturer. Arbitrary conversions or modifications are explicitly forbidden. For safety reasons, only the accessory specified by the manufacturer must be used.

To avoid any danger, the safety approval markings and safety tips on the device must also be observed and their meaning read in this operating instructions manual.

Depending on the instrument version, the emitting frequencies are in the C, K or W band range. The low emission power is far below the internationally approved limit values. When used correctly, the device poses no danger to health.

2.5 EU conformity

The device fulfils the legal requirements of the applicable EU directives. By affixing the CE marking, we confirm the conformity of the instrument with these directives.

You can find the EU conformity declaration on our website under www.vega.com/downloads.

Electromagnetic compatibility

Instruments in four-wire or Ex-d-ia version are designed for use in an industrial environment. Nevertheless, electromagnetic interference from electrical conductors and radiated emissions must be taken into account, as is usual with class A instruments according to EN 61326-1. If the instrument is used in a different environment, the electromagnetic compatibility to other instruments must be ensured by suitable measures.

2.6 NAMUR recommendations

NAMUR is the automation technology user association in the process industry in Germany. The published NAMUR recommendations are accepted as the standard in field instrumentation.

The device fulfils the requirements of the following NAMUR recommendations:

- NE 21 – Electromagnetic compatibility of equipment
- NE 43 – Signal level for fault information from measuring transducers
- NE 53 – Compatibility of field devices and display/adjustment components
- NE 107 – Self-monitoring and diagnosis of field devices

For further information see www.namur.de.

2.7 Radio license for Europe

The instrument was tested according to the latest issue of the following harmonized standards:

- EN 302372 - Tank Level Probing Radar

It is hence approved for use inside closed vessels in countries of the EU.

Use is also approved in EFTA countries, provided the respective standards have been implemented.

For operation inside of closed vessels, points a to f in annex E of EN 302372 must be fulfilled.

2.8 Radio license for USA

This approval is only valid for USA. Hence the following text is only available in the English language.

This device complies with Part 15 of the FCC Rules. Operation is subject to the following two conditions:

- This device may not cause interference, and
- This device must accept any interference, including interference that may cause undesired operation of the device

This device is approved for unrestricted use only inside closed, stationary vessels made of metal, reinforced fiberglass or concrete.

Changes or modifications not expressly approved by the manufacturer could void the user's authority to operate this equipment.

2.9 Installation and operation in the USA and Canada

This information is only valid for USA and Canada. Hence the following text is only available in the English language.

Installations in the US shall comply with the relevant requirements of the National Electrical Code (ANSI/NFPA 70).

Installations in Canada shall comply with the relevant requirements of the Canadian Electrical Code

A Class 2 power supply unit has to be used for the installation in the USA and Canada.

2.10 Environmental instructions

Protection of the environment is one of our most important duties. That is why we have introduced an environment management system with the goal of continuously improving company environmental protection. The environment management system is certified according to DIN EN ISO 14001.

Please help us fulfil this obligation by observing the environmental instructions in this manual:

- Chapter "*Packaging, transport and storage*"
- Chapter "*Disposal*"

3 Product description

3.1 Configuration

Type label

The type label contains the most important data for identification and use of the instrument:

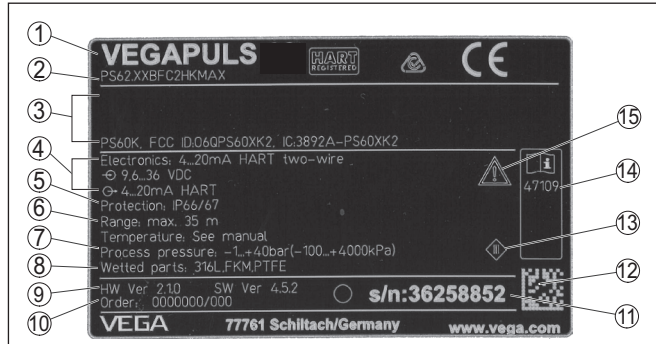

Fig. 1: Layout of the type label (example)

- 1 Instrument type
- 2 Product code
- 3 Approvals
- 4 Power supply and signal output, electronics
- 5 Protection rating
- 6 Measuring range
- 7 Process and ambient temperature, process pressure
- 8 Material wetted parts
- 9 Hardware and software version
- 10 Order number
- 11 Serial number of the instrument
- 12 Data matrix code for VEGA Tools app
- 13 Symbol of the device protection class
- 14 ID numbers, instrument documentation
- 15 Reminder to observe the instrument documentation

Serial number - Instrument search

The type label contains the serial number of the instrument. With it you can find the following instrument data on our homepage:

- Product code (HTML)
- Delivery date (HTML)
- Order-specific instrument features (HTML)
- Operating instructions and quick setup guide at the time of shipment (PDF)
- Order-specific sensor data for an electronics exchange (XML)
- Test certificate (PDF) - optional

Go to "www.vega.com", "Search". Enter the serial number.

Alternatively, you can access the data via your smartphone:

- Download the VEGA Tools app from the "Apple App Store" or the "Google Play Store"
- Scan the Data Matrix code on the type label of the instrument or
- Enter the serial number manually in the app

Scope of this operating instructions This operating instructions manual applies to the following instrument versions:

- Hardware version from 2.1.0
- Software version from 4.5.3

Scope of delivery The scope of delivery encompasses:

- Radar sensor
- Documentation
 - Quick setup guide VEGAPULS 65
 - Instructions for optional instrument features
 - Ex-specific "*Safety instructions*" (with Ex versions)
 - If necessary, further certificates

i Information: The optional instrument features are described in the operating instructions manual. The respective scope of delivery results from the order specification.

3.2 Principle of operation

Application area The VEGAPULS 65 is a radar sensor for continuous measurement of liquids under simple process conditions. It is particularly suitable for level measurement in vessels with small process fittings and under simple process conditions.

The instrument can be used with products with an ϵ_r value ≥ 1.8 . The actually achievable value depends on the measuring conditions, the antenna system, the standpipe or bypass.

Functional principle The antenna of the radar sensor emits short radar pulses with a duration of approx. 1 ns. These pulses are reflected by the product and received by the antenna as echoes. The transit time of the radar pulses from emission to reception is proportional to the distance and hence to the level. The determined level is converted into an appropriate output signal and outputted as measured value.

3.3 Packaging, transport and storage

Packaging Your instrument was protected by packaging during transport. Its capacity to handle normal loads during transport is assured by a test based on ISO 4180.

The packaging of standard instruments consists of environment-friendly, recyclable cardboard. For special versions, PE foam or PE foil is also used. Dispose of the packaging material via specialised recycling companies.

Transport Transport must be carried out in due consideration of the notes on the transport packaging. Nonobservance of these instructions can cause damage to the device.

Transport inspection The delivery must be checked for completeness and possible transit damage immediately at receipt. Ascertained transit damage or concealed defects must be appropriately dealt with.

Storage

Up to the time of installation, the packages must be left closed and stored according to the orientation and storage markings on the outside.

Unless otherwise indicated, the packages must be stored only under the following conditions:

- Not in the open
- Dry and dust free
- Not exposed to corrosive media
- Protected against solar radiation
- Avoiding mechanical shock and vibration

Storage and transport temperature

- Storage and transport temperature see chapter "*Supplement - Technical data - Ambient conditions*"
- Relative humidity 20 ... 85 %

Lifting and carrying

With instrument weights of more than 18 kg (39.68 lbs) suitable and approved equipment must be used for lifting and carrying.

3.4 Accessories and replacement parts**PLICSCOM**

The display and adjustment module PLICSCOM is used for measured value indication, adjustment and diagnosis. It can be inserted into the sensor or the external display and adjustment unit and removed at any time.

The integrated Bluetooth module (optional) enables wireless adjustment via standard adjustment devices:

- Smartphone/tablet (iOS or Android operating system)
- PC/notebook with Bluetooth USB adapter (Windows operating system)

You can find further information in the operating instructions "*Display and adjustment module PLICSCOM*" (Document-ID 36433).

VEGACONNECT

The interface adapter VEGACONNECT enables the connection of communication-capable instruments to the USB interface of a PC. For parameter adjustment of these instruments, the adjustment software PACTware with VEGA-DTM is required.

You can find further information in the operating instructions "*Interface adapter VEGACONNECT*" (Document-ID 32628).

VEGADIS 81

The VEGADIS 81 is an external display and adjustment unit for VEGA plics® sensors.

For sensors with double chamber housing the interface adapter "*VEGADIS adapter*" is also required for VEGADIS 81.

You can find further information in the operating instructions "*VEGADIS 81*" (Document-ID 43814).

VEGADIS adapter

The VEGADIS adapter is an accessory part for sensors with double chamber housings. It enables the connection of VEGADIS 81 to the sensor housing via an M12 x 1 plug.

You can find further information in the supplementary instructions "*VEGADIS adapter*" (Document-ID 45250).

VEGADIS 82

VEGADIS 82 is suitable for measured value indication and adjustment of sensors with HART protocol. It is looped into the 4 ... 20 mA/HART signal cable.

You can find further information in the operating instructions "*VEGADIS 82 4 ... 20 mA/HART*" (Document-ID 45300).

PLICSMOBILE T81

PLICSMOBILE T81 is an external GSM/GPRS/UMTS radio unit for transmission of measured values and for remote parameter adjustment of HART sensors. The adjustment is carried out via a PC with PACTware and the corresponding DTM or via smartphone/tablet with the VEGA Tools app. The connection is made via the Bluetooth interface integrated in PLICSMOBILE.

You can find further information in the operating instructions "*PLICSMOBILE T81/B81/S81*" (Document-ID 55234).

PLICSMOBILE 81

PLICSMOBILE 81 is an internal GSM/GPRS/UMTS radio unit for HART sensors for transmission of measured values and for remote parameter adjustment. The adjustment is carried out via a PC with PACTware and the corresponding DTM or via smartphone/tablet with the VEGA Tools app. The connection is made via the Bluetooth interface integrated in PLICSMOBILE.

You can find further information in the supplementary instructions "*PLICSMOBILE*" (Document-ID 56160).

Protective cover

The protective cover protects the sensor housing against soiling and intense heat from solar radiation.

You will find additional information in the supplementary instructions manual "*Protective cover*" (Document-ID 34296).

Flanges

Screwed flanges are available in different versions according to the following standards: DIN 2501, EN 1092-1, BS 10, ASME B 16.5, JIS B 2210-1984, GOST 12821-80.

You can find additional information in the supplementary instructions manual "*Flanges according to DIN-EN-ASME-JIS*".

Electronics module

Electronics module "VEGAPULS series 60" is a replacement part for radar sensors of VEGAPULS series 60. A different version is available for each type of signal output.

You can find further information in the operating instructions "*Electronics module VEGAPULS series 60*" (Document-ID 36801).

Supplementary electronics for double chamber housing

The supplementary electronics is a replacement part for 4 ... 20 mA/HART sensors with double chamber housing.

You can find further information in the operating instructions "*Supplementary electronics for 4 ... 20 mA/HART - two-wire*" (Document-ID 42764).

4 Mounting

4.1 General instructions

Screwing in

On devices with a threaded fitting, the hexagon on the process fitting must be tightened with a suitable wrench.

See chapter "*Dimensions*" for wrench size.



Warning:

The housing or the electrical connection may not be used for screwing in! Tightening can cause damage, e. g. to the rotation mechanism of the housing.

Protection against moisture

Protect your instrument against moisture ingress through the following measures:

- Use a suitable connection cable (see chapter "*Connecting to power supply*")
- Tighten the cable gland or plug connector
- When mounting horizontally, turn the housing so that the cable gland or plug connector point downward
- Lead the connection cable downward in front of the cable entry or plug connector.

This applies mainly to outdoor installations, in areas where high humidity is expected (e.g. through cleaning processes) and on cooled or heated vessels.

To maintain the housing protection, make sure that the housing lid is closed during operation and locked, if necessary.

Make sure that the degree of contamination specified in chapter "*Technical data*" meets the existing ambient conditions.

Suitability for the process conditions

Make sure before mounting that all parts of the instrument exposed to the process are suitable for the existing process conditions.

These are mainly:

- Active measuring component
- Process fitting
- Process seal

Process conditions in particular are:

- Process pressure
- Process temperature
- Chemical properties of the medium
- Abrasion and mechanical influences

You can find detailed information on the process conditions in chapter "*Technical data*" as well as on the type label.

Suitability for the ambient conditions

The instrument is suitable for standard and extended ambient conditions acc. to IEC/EN 61010-1.

4.2 Mounting instructions

Sealing to the process

The PTFE washer of the antenna encapsulation serves also as process seal.

After a certain time under the effect of large temperature changes, PTFE plated flanges tend to lose their pre-tensioning. To compensate for this, disc springs must be used with the flange screws.

We recommended using elastic washers or detent-edged washers:

Screw size	Disc spring type	Article no.
M16, $\frac{5}{8}$ "	Detent edged ring Gross VS KD	2.32880
M20, $\frac{3}{4}$ "	Detent edged ring Gross VS KD	2.32881
M24, $\frac{7}{8}$ "	Retaining washer Schnorr VS, S	2.32882



Note:

The retaining elements are included with the versions for process temperatures -196 ... +200 °C (-321 ... +392 °F).

To seal effectively, the following requirements must be fulfilled:

1. Make sure the number of flange screws corresponds to the number of flange holes
2. Use of disc springs as previously described

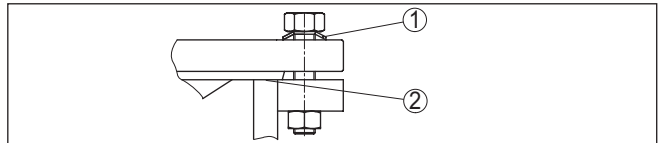

Fig. 2: Use of disc springs

- 1 Disc spring
- 2 Sealing surface

3. Tighten screws with the necessary torque (see chapter "Technical data")



Note:

We recommend re-tightening the screws at regular intervals, depending on process pressure and temperature. Recommended torque, see chapter "Technical data", "Torques".

Polarisation

The emitted radar impulses of the radar sensor are electromagnetic waves. The polarisation is the direction of the electrical wave component. By turning the instrument in the connection flange or mounting boss, the polarisation can be used to reduce the effects of false echoes.

The position of the polarisation is marked on the process fitting of the instrument.

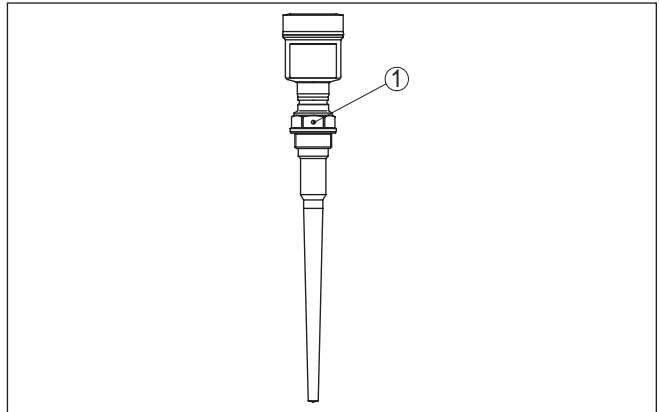

Fig. 3: Position of the polarisation

1 Marking hole

Installation position

When mounting the VEGAPULS 65, keep a distance of at least 500 mm (19.69 in) to the vessel wall. If the sensor is installed in the center of dished or round vessel tops, multiple echoes can arise. These can, however, be suppressed by an appropriate adjustment (see chapter "Setup").

If you cannot maintain this distance, you should carry out a false signal suppression during setup. This applies particularly if buildup on the vessel wall is expected. In such cases, we recommend repeating the false signal suppression at a later date with existing buildup.

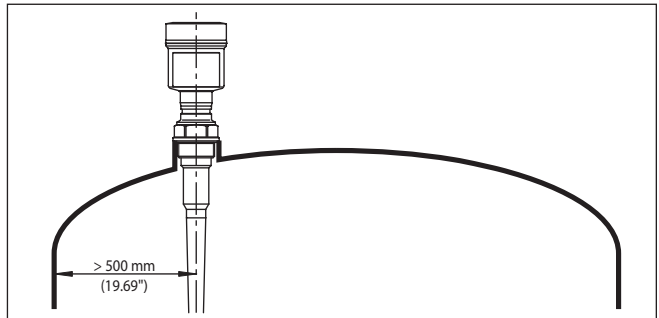

Fig. 4: Mounting of the radar sensor on round vessel tops

In vessels with conical bottom it can be advantageous to mount the sensor in the centre of the vessel, as measurement is then possible down to the bottom.

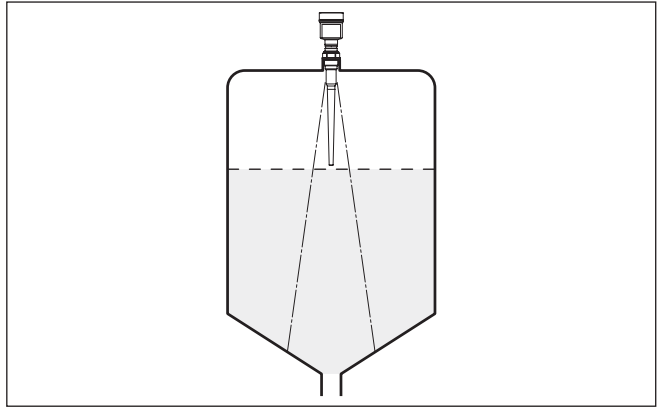

Fig. 5: Mounting of the radar sensor on vessels with conical bottom

Inflowing medium

Do not mount the instruments in or above the filling stream. Make sure that you detect the product surface, not the inflowing product.

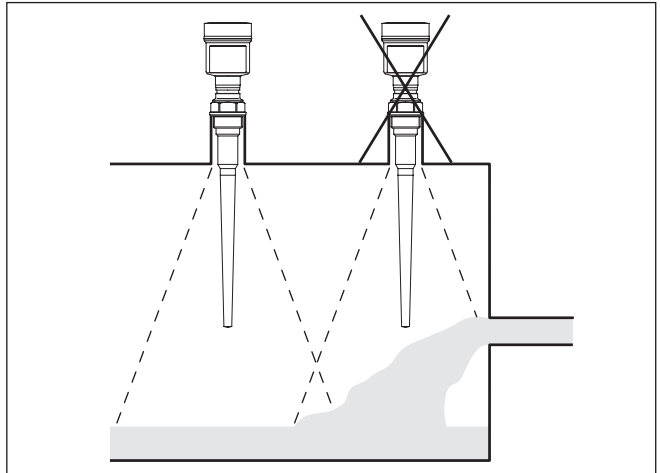

Fig. 6: Mounting of the radar sensor with inflowing medium

Mounting socket

The active part of the antenna, i.e. the conical antenna part should protrude completely out of the socket.

To meet the different socket dimensions, sensors for socket lengths up to 50, 100 and 250 mm (2, 4, 10 in) are available.

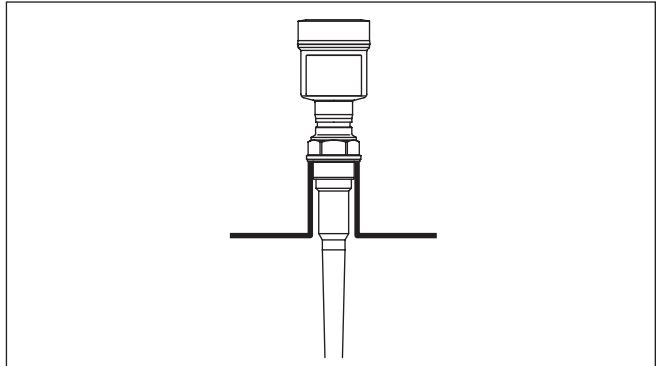

Fig. 7: Recommended socket mounting

In case of very big socket diameters, the active antenna part can be slightly recessed in the socket. The following rule applies to the standard version of VEGAPULS 65: Socket diameter corresponds to max. socket height.

Sensor orientation

In liquids, direct the sensor as perpendicular as possible to the product surface to achieve optimum measurement results.

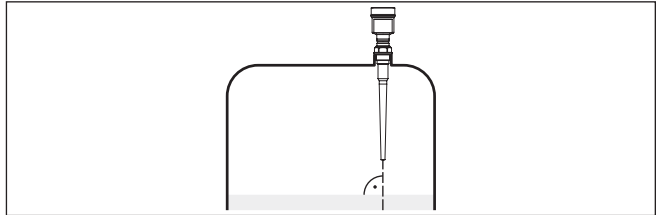

Fig. 8: Alignment in liquids

Vessel installations

The mounting location of the radar sensor should be a place where no other equipment or fixtures cross the path of the radar signals.

Vessel installations, such as e.g. ladders, limit switches, heating spirals, struts, etc., can cause false echoes and impair the useful echo. Make sure when planning your measuring point that the radar sensor has a "clear view" to the measured product.

In case of existing vessel installations, a false signal suppression should be carried out during setup.

If large vessel installations such as struts or supports cause false echoes, these can be attenuated through supplementary measures. Small, inclined sheet metal baffles above the installations scatter the radar signals and prevent direct interfering reflections.

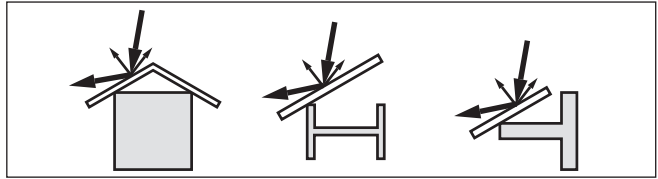

Fig. 9: Cover flat, large-area profiles with deflectors

Agitators

If there are agitators in the vessel, a false signal suppression should be carried out with the agitators in motion. This ensures that the interfering reflections from the agitators are saved with the blades in different positions.

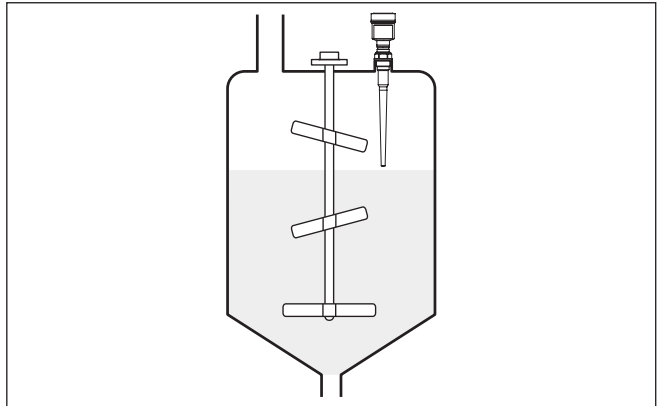

Fig. 10: Agitators

Foam generation

Through the action of filling, stirring and other processes in the vessel, dense foams which considerably damp the emitted signals may form on the product surface.

If foam is causing measurement errors, the largest possible radar antenna should be used.

As an alternative, sensors with guided microwave can be used. These are unaffected by foam generation and are best suited for such applications.

5 Connecting to power supply

5.1 Preparing the connection

Safety instructions

Always keep in mind the following safety instructions:

- Carry out electrical connection by trained, qualified personnel authorised by the plant operator
- If overvoltage surges are expected, overvoltage arresters should be installed



Warning:

Connect only in the complete absence of line voltage.

Voltage supply

Power supply and current signal are carried on the same two-wire cable. The operating voltage can differ depending on the instrument version.

The data for power supply are specified in chapter "*Technical data*".

Provide a reliable separation between the supply circuit and the mains circuits according to DIN EN 61140 VDE 0140-1.

Power the instrument via an energy-limited circuit acc. to IEC 61010-1, e.g. via Class 2 power supply unit.

Keep in mind the following additional factors that influence the operating voltage:

- Lower output voltage of the power supply unit under nominal load (e.g. with a sensor current of 20.5 mA or 22 mA in case of fault)
- Influence of additional instruments in the circuit (see load values in chapter "*Technical data*")

Connection cable

An approved, three-wire installation cable with PE conductor is required for voltage supply with mains voltage.

The 4 ... 20 mA current output is connected with standard two-wire cable without screen. If electromagnetic interference is expected which is above the test values of EN 61326-1 for industrial areas, screened cable should be used.

Make sure that the cable used has the required temperature resistance and fire safety for max. occurring ambient temperature

Use cable with round cross section for instruments with housing and cable gland. Use a cable gland suitable for the cable diameter to ensure the seal effect of the cable gland (IP protection rating).

Cable glands

Metric threads

In the case of instrument housings with metric thread, the cable glands are screwed in at the factory. They are sealed with plastic plugs as transport protection.

You have to remove these plugs before electrical connection.

NPT thread

In the case of instrument housings with self-sealing NPT threads, it is not possible to have the cable entries screwed in at the factory. The

free openings for the cable glands are therefore covered with red dust protection caps as transport protection.

Prior to setup you have to replace these protective caps with approved cable glands or close the openings with suitable blind plugs.

On plastic housings, the NPT cable gland or the Conduit steel tube must be screwed into the threaded insert without grease.

Max. torque for all housings, see chapter "*Technical data*".

Cable screening and grounding

If screened cable is required, we recommend connecting the cable screening on both ends to ground potential. In the sensor, the cable screening must be connected directly to the internal ground terminal. The ground terminal on the outside of the housing must be connected to the ground potential (low impedance).



In Ex systems, the grounding is carried out according to the installation regulations.

In electroplating plants as well as plants for cathodic corrosion protection it must be taken into account that significant potential differences exist. This can lead to unacceptably high currents in the cable screen if it is grounded at both ends.



Information:

The metallic parts of the instrument (process fitting, sensor, concentric tube, etc.) are connected with the internal and external ground terminal on the housing. This connection exists either directly via the conductive metallic parts or, in case of instruments with external electronics, via the screen of the special connection cable.

You can find specifications on the potential connections inside the instrument in chapter "*Technical data*".

5.2 Connecting

Connection technology

The voltage supply and signal output are connected via the spring-loaded terminals in the housing.

Connection to the display and adjustment module or to the interface adapter is carried out via contact pins in the housing.



Information:

The terminal block is pluggable and can be removed from the electronics. To do this, lift the terminal block with a small screwdriver and pull it out. When reinserting the terminal block, you should hear it snap in.

Connection procedure

Proceed as follows:

1. Unscrew the housing lid
2. If a display and adjustment module is installed, remove it by turning it slightly to the left
3. Loosen compression nut of the cable gland and remove blind plug
4. Remove approx. 10 cm (4 in) of the cable mantle, strip approx. 1 cm (0.4 in) of insulation from the ends of the individual wires

5. Insert the cable into the sensor through the cable entry

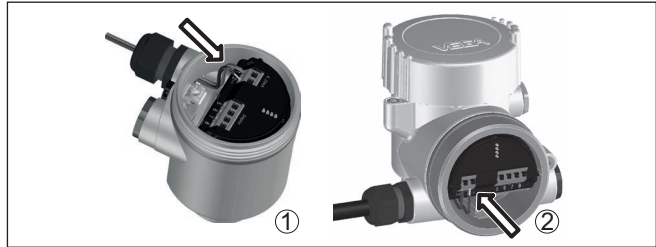

Fig. 11: Connection steps 5 and 6

- 1 Single chamber housing
2 Double chamber housing

6. Insert the wire ends into the terminals according to the wiring plan



Information:

Solid cores as well as flexible cores with wire end sleeves are inserted directly into the terminal openings. In case of flexible cores without end sleeves, press the terminal from above with a small screwdriver, the terminal opening is then free. When the screwdriver is released, the terminal closes again.

You can find further information on the max. wire cross-section under "*Technical data - Electromechanical data*".

7. Check the hold of the wires in the terminals by lightly pulling on them
8. Connect the screen to the internal ground terminal, connect the external ground terminal to potential equalisation
9. Tighten the compression nut of the cable entry gland. The seal ring must completely encircle the cable
10. Reinsert the display and adjustment module, if one was installed
11. Screw the housing lid back on

The electrical connection is finished.

5.3 Wiring plan, single chamber housing



The following illustration applies to the non-Ex as well as to the Ex-ia version.

Electronics and connection compartment

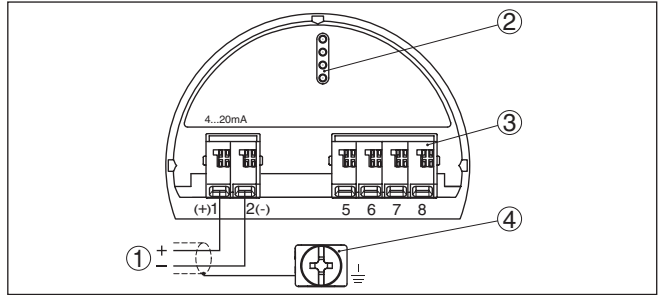

Fig. 12: Electronics and connection compartment - single chamber housing

- 1 Voltage supply, signal output
- 2 For display and adjustment module or interface adapter
- 3 For external display and adjustment unit
- 4 Ground terminal for connection of the cable screening

5.4 Wiring plan, double chamber housing



The following illustrations apply to the non-Ex as well as to the Ex-ia version.

Electronics compartment

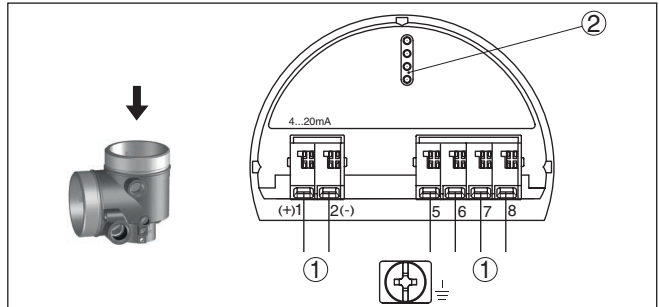

Fig. 13: Electronics compartment - double chamber housing

- 1 Internal connection to the connection compartment
- 2 For display and adjustment module or interface adapter

Connection compartment

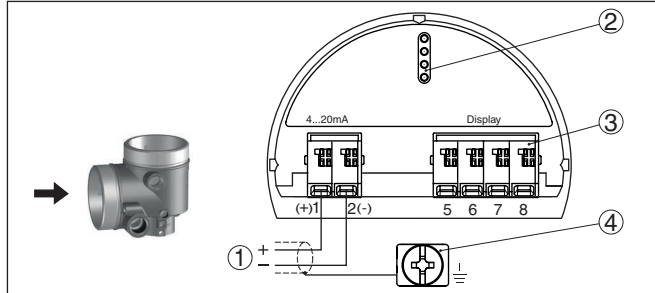

Fig. 14: Connection compartment - double chamber housing

- 1 Voltage supply, signal output
- 2 For display and adjustment module or interface adapter
- 3 For external display and adjustment unit
- 4 Ground terminal for connection of the cable screening

**Connection compartment - Radio module
PLICSMOBILE 81**

Fig. 15: Connection compartment - Radio module PLICSMOBILE 81

- 1 Voltage supply

You can find detailed information for connection in the operating instructions "PLICSMOBILE".

5.5 Wiring plan, Ex-d-ia double chamber housing

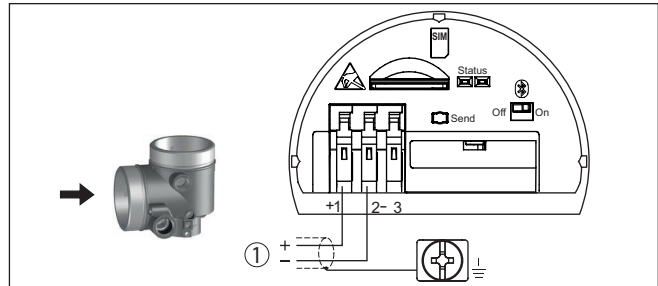
Electronics compartment

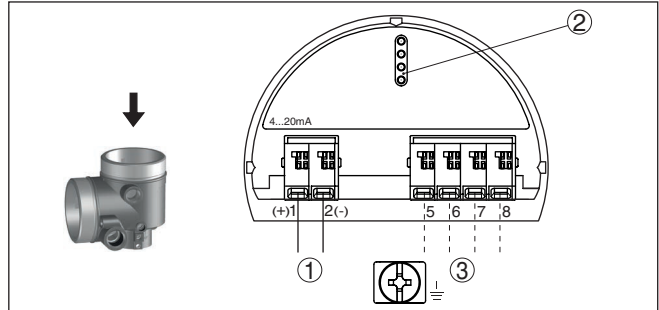

Fig. 16: Electronics compartment - Ex-d-ia double chamber housing

- 1 Internal connection to the connection compartment
- 2 For display and adjustment module or interface adapter
- 3 Internal connection to the plug connector for external display and adjustment unit (optional)



Note:

HART multidrop mode is not possible when using an Ex-d-ia instrument.

Connection compartment

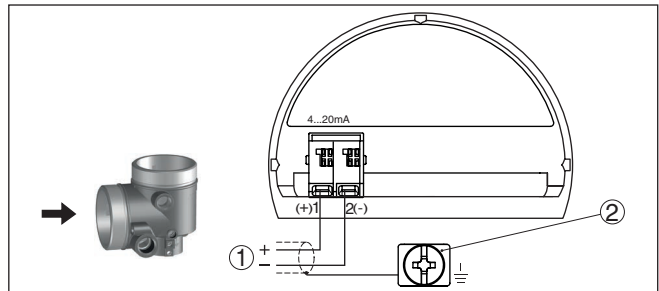

Fig. 17: Connection compartment - Ex-d-ia double chamber housing

- 1 Voltage supply, signal output
- 2 Ground terminal for connection of the cable screening

Plug M12 x 1 for external display and adjustment unit

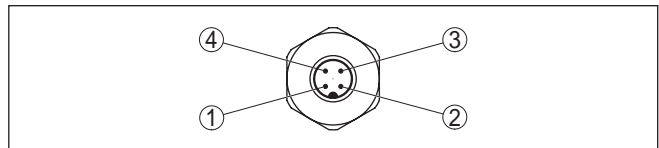

Fig. 18: Top view of the plug connector

- 1 Pin 1
- 2 Pin 2
- 3 Pin 3
- 4 Pin 4

Contact pin	Colour, connection cable in the sensor	Terminal, electronics module
Pin 1	Brown	5
Pin 2	White	6
Pin 3	Blue	7
Pin 4	Black	8

5.6 Double chamber housing with VEGADIS-Adapter

Electronics compartment

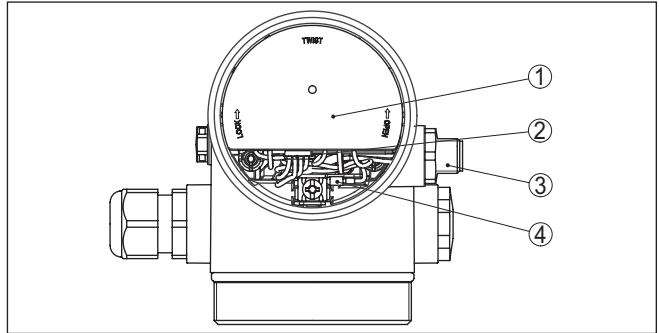

Fig. 19: View to the electronics compartment with VEGADIS adapter for connection of the external display and adjustment unit

- 1 VEGADIS adapter
- 2 Internal plug connection
- 3 Plug connector M12 x 1

Assignment of the plug connector

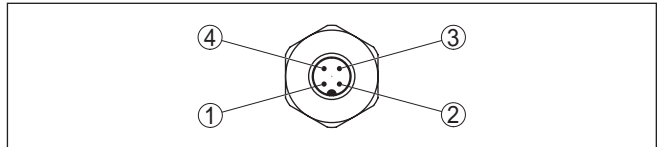

Fig. 20: View to the plug connector M12 x 1

- 1 Pin 1
- 2 Pin 2
- 3 Pin 3
- 4 Pin 4

Contact pin	Colour, connection cable in the sensor	Terminal, electronics module
Pin 1	Brown	5
Pin 2	White	6
Pin 3	Blue	7
Pin 4	Black	8

Wire assignment, connection cable**5.7 Wiring plan - version IP 66/IP 68, 1 bar**

Fig. 21: Wire assignment in permanently connected connection cable

- 1 Brown (+) and blue (-) to power supply or to the processing system
- 2 Shielding

5.8 Switch-on phase

After connecting the instrument to voltage supply or after a voltage recurrence, the instrument carries out a self-check for approx. 30 s:

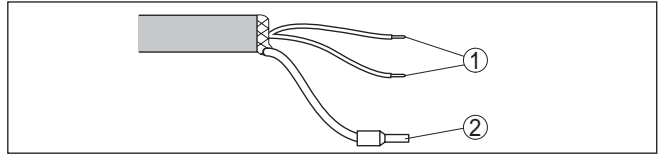
- Internal check of the electronics
- Indication of the instrument type, hardware and software version, measurement loop name on the display or PC
- Indication of the status message "*F 105 Determine measured value*" on the display or PC
- The output signal jumps to the set fault current

As soon as a plausible measured value is found, the corresponding current is output to the signal cable. The value corresponds to the actual level as well as the settings already carried out, e.g. factory setting.

6 Set up with the display and adjustment module

6.1 Insert display and adjustment module

The display and adjustment module can be inserted into the sensor and removed again at any time. You can choose any one of four different positions - each displaced by 90°. It is not necessary to interrupt the power supply.

Proceed as follows:

1. Unscrew the housing lid
2. Place the display and adjustment module on the electronics in the desired position and turn it to the right until it snaps in.
3. Screw housing lid with inspection window tightly back on

Disassembly is carried out in reverse order.

The display and adjustment module is powered by the sensor, an additional connection is not necessary.



Fig. 22: Installing the display and adjustment module in the electronics compartment of the single chamber housing

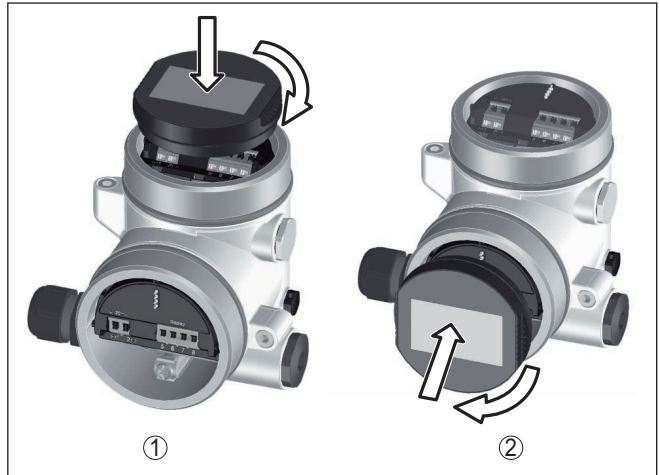

Fig. 23: Installing the display and adjustment module in the double chamber housing

- 1 In the electronics compartment
- 2 In the connection compartment



Note:

If you intend to retrofit the instrument with a display and adjustment module for continuous measured value indication, a higher lid with an inspection glass is required.

6.2 Adjustment system

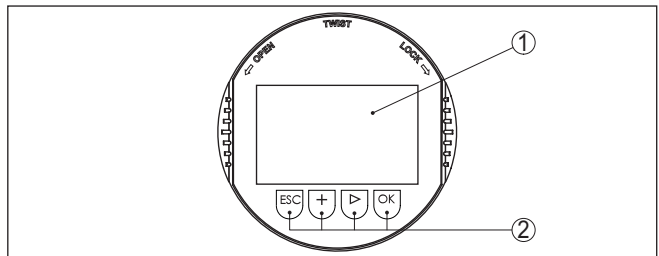

Fig. 24: Display and adjustment elements

- 1 LC display
- 2 Adjustment keys

Key functions

- **[OK]** key:
 - Move to the menu overview
 - Confirm selected menu
 - Edit parameter
 - Save value
- **[->]** key:
 - Change measured value presentation
 - Select list entry

- Select menu items in the quick setup menu
- Select editing position
- **[+]** key:
 - Change value of the parameter
- **[ESC]** key:
 - Interrupt input
 - Jump to next higher menu

Operating system - Keys direct

The instrument is operated via the four keys of the display and adjustment module. The individual menu items are shown on the LC display. You can find the function of the individual keys in the previous illustration.

Adjustment system - keys via magnetic pen

With the Bluetooth version of the display and adjustment module you can also adjust the instrument with the magnetic pen. The pen operates the four keys of the display and adjustment module right through the closed lid (with inspection window) of the sensor housing.

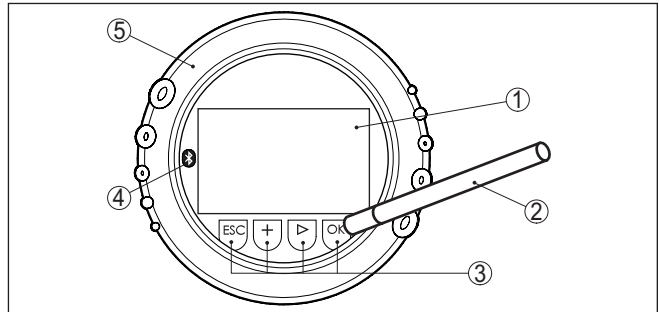

Fig. 25: Display and adjustment elements - with adjustment via magnetic pen

- 1 LC display
- 2 Magnetic pen
- 3 Adjustment keys
- 4 Bluetooth symbol
- 5 Lid with inspection window

Time functions

When the **[+]** and **[>]** keys are pressed quickly, the edited value, or the cursor, changes one value or position at a time. If the key is pressed longer than 1 s, the value or position changes continuously.

When the **[OK]** and **[ESC]** keys are pressed simultaneously for more than 5 s, the display returns to the main menu. The menu language is then switched over to "English".

Approx. 60 minutes after the last pressing of a key, an automatic reset to measured value indication is triggered. Any values not confirmed with **[OK]** will not be saved.

6.3 Measured value indication - Selection of national language

With the **[>]** key you move between three different indication modes.

Measured value indication

In the first view, the selected measured value is displayed in large digits.

In the second view, the selected measured value and a corresponding bar graph presentation are displayed.

In the third view, the selected measured value as well as a second selectable value, e.g. the temperature of the electronics, are displayed.

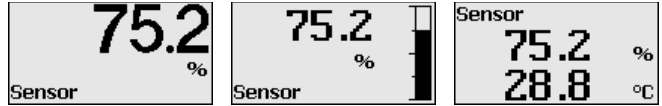

During the initial setup of an instrument shipped with factory settings, use the "OK" key to get to the menu "National language".

Selection of national language

This menu item is used to select the national language for further parameter adjustment. You can change the selection via the menu item "Setup - Display, Menu language".

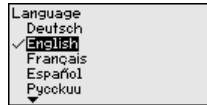

With the "OK" key you move to the main menu.

6.4 Parameter adjustment

The instrument is adapted to the application conditions via the parameter adjustment. The parameter adjustment is carried out with an adjustment menu.

Main menu

The main menu is divided into five sections with the following functions:

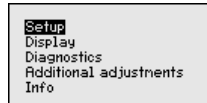

Setup: Settings, e.g., for measurement loop name, medium, application, vessel, adjustment, signal output

Display: Settings, e.g., for language, measured value display, lighting

Diagnostics: Information, e.g. on instrument status, pointer, measurement reliability, simulation, echo curve

Further settings: Instrument unit, false signal suppression, linearisation curve, reset, date/time, reset, copy function

Info: Instrument name, hardware and software version, date of manufacture, instrument features



Information:

In this operating instructions manual, the instrument-specific parameters in the menu sections "Setup", "Diagnosis" and "Additional settings" are described. The general parameters in these menu sections are described in the operating instructions manual "Display and adjustment module".

In the operating instructions manual "*Display and adjustment module*" you can also find the description of menu sections "*Display*" and "*Info*".

In the main menu item "*Setup*", the individual submenu items should be selected one after the other and provided with the correct parameters to ensure optimum adjustment of the measurement. The procedure is described in the following.

Setup - Measurement loop name

In the menu item "*Sensor TAG*" you edit a twelve-digit measurement loop designation.

You can enter an unambiguous designation for the sensor, e.g. the measurement loop name or the tank or product designation. In digital systems and in the documentation of larger plants, a singular designation must be entered for exact identification of individual measuring points.

The available digits include:

- Letters from A ... Z
- Numbers from 0 ... 9
- Special characters +, -, /, -

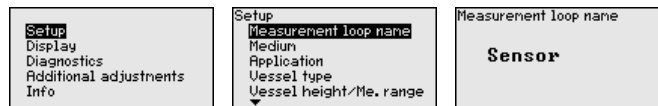

Setup - Medium

Every medium has different reflective properties. With liquids, there are additional interfering factors such as turbulent product surface and foam generation. With bulk solids, the additional interfering factors are dust generation, angle of repose and secondary echoes from the vessel wall.

To adapt the sensor to these different measuring conditions, the selection "*Liquid*" or "*Bulk solid*" should be made in this menu item.

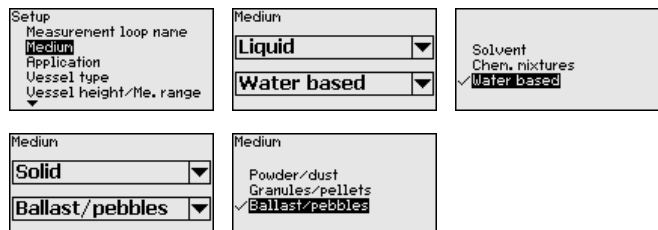

Through this selection, the sensor is optimally adapted to the product, and measurement reliability, particularly in products with poor reflective properties, is considerably increased.

Enter the requested parameters via the appropriate keys, save your settings with **[OK]** and jump to the next menu item with the **[ESC]** and the **[->]** key.

Setup - Application

In addition to the medium, also the application, i.e. the measuring site, can influence the measurement.

With this menu item, the sensor can be adapted to the applications. The adjustment possibilities depend on the selection "Liquid" or "Bulk solid" under "Medium".

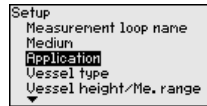

The following options are available when "Liquid" is selected:

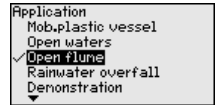
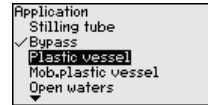
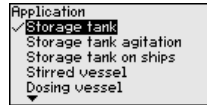

The selection "Standpipe" opens a new window in which the inner diameter of the applied standpipe is entered.

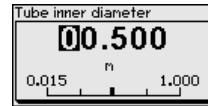
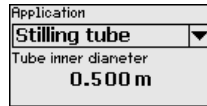

Following the characteristics of the applications and the metrological features of the sensor are described.



Note:

Probably the operation of the instrument in the following applications is subject to national restrictions in respect to the radio license (see chapter "For your safety"):

- Plastic tank
- Transportable plastic tank
- Open water
- Open flume
- Rain water spillover

Storage tank:

- Setup: large-volumed, upright cylindrical, spherical
- Medium speed: slow filling and emptying
- Process/measurement conditions:
 - Condensation
 - Smooth product surface
 - High requirements on measurement accuracy
- Properties, sensor:
 - Low sensitivity to sporadic false echoes
 - Stable and reliable measured values through averaging
 - High measurement accuracy
 - Short reaction time of the sensor not required

Storage tank, circulation:

- Setup: large-volumed, upright cylindrical, spherical
- Medium speed: slow filling and emptying
- Installations: small, laterally mounted or large, top mounted stirrer
- Process/measurement conditions:
 - Relatively smooth product surface

- High requirements on measurement accuracy
- Condensation
- Slight foam generation
- Overfilling possible
- Properties, sensor:
 - Low sensitivity to sporadic false echoes
 - Stable and reliable measured values through averaging
 - High measurement accuracy, because not set for max. speed
 - False signal suppression recommended

Storage tank on ships:

- Medium speed: slow filling and emptying
- Vessel:
 - Installations in the bottom section (bracers, heating spirals)
 - High sockets 200 ... 500 mm, also with large diameters
- Process/measurement conditions:
 - Condensation, buildup by movement
 - Max. requirement on measurement accuracy from 95 %
- Properties, sensor:
 - Low sensitivity to sporadic false echoes
 - Stable and reliable measured values through averaging
 - High measurement accuracy
 - False signal suppression required

Stirrer vessel:

- Setup: all vessel sizes possible
- Medium speed:
 - Fast to slow filling possible
 - Vessel is filled and emptied very often
- Vessel:
 - Socket available
 - Large agitator blades of metal
 - Vortex breakers, heating spirals
- Process/measurement conditions:
 - Condensation, buildup by movement
 - Strong spout generation
 - Very agitated surface, foam generation
- Properties, sensor:
 - Higher measurement speed through less averaging
 - Sporadic false echoes are suppressed

Dosing vessel:

- Setup: all vessel sizes possible
- Medium speed:
 - Fast filling and emptying
 - Vessel is filled and emptied very often
- Vessel: tight installation situation
- Process/measurement conditions:
 - Condensation, buildup on the antenna
 - Foam generation
- Properties, sensor:
 - Measurement speed optimized by virtually no averaging
 - Sporadic false echoes are suppressed

- False signal suppression recommended

Standpipe:

- Medium speed: very fast filling and emptying
- Vessel:
 - Vent hole
 - Joins like flanges, weld joints
 - Shifting of the running time in the tube
- Process/measurement conditions:
 - Condensation
 - Buildup
- Properties, sensor:
 - Measurement speed optimized through little averaging
 - Entering the tube inside diameter takes the running time shift into consideration
 - Echo detection sensitivity reduced

Bypass:

- Medium speed:
 - Fast up to slow filling with short up to long bypass tube possible
 - Often the level is hold via a control facility
- Vessel:
 - Lateral outlets and inlets
 - Joins like flanges, weld joints
 - Shifting of the running time in the tube
- Process/measurement conditions:
 - Condensation
 - Buildup
 - Separation of oil and water possible
 - Overflowing into the antenna possible
- Properties, sensor:
 - Measurement speed optimized through little averaging
 - Entering the tube inside diameter takes the running time shift into consideration
 - Echo detection sensitivity reduced
 - False signal suppression recommended

Plastic tank:

- Vessel:
 - Instrument fix mounted or built in
 - Measurement through the vessel top, if appropriate to the application
 - With empty vessel, the measurement can go through the bottom
- Process/measurement conditions:
 - Condensation on the plastic ceiling
 - In outdoor facilities, water and snow on vessel top possible
- Properties, sensor:
 - False signals outside the vessel are not taken into consideration
 - False signal suppression recommended

Transportable plastic tank:

- Vessel:

- Material and thickness different
- Measurement through the vessel top
- Process/measurement conditions:
 - Measured value jump with vessel change
- Properties, sensor:
 - Quick adaptation to changing reflection conditions due to vessel change
 - False signal suppression required

Open water:

- Rate of level change: slow level change
- Process/measurement conditions:
 - Large distance from sensor to water surface
 - Extreme damping of output signal due to wave generation
 - Ice and condensation on the antenna possible
 - Spiders and insects build nests in the antennas
 - Floating material and animals sporadically appear on water surface
- Properties, sensor:
 - Stable and reliable measured values through frequent averaging
 - Insensitive in the close range

Open flume:

- Rate of level change: slow level change
- Process/measurement conditions:
 - Ice and condensation on the antenna possible
 - Spiders and insects build nests in the antennas
 - Smooth water surface
 - Exact measurement result required
 - Distance to the water surface normally relatively large
- Properties, sensor:
 - Stable and reliable measured values through frequent averaging
 - Insensitive in the close range

Rain water spillover:

- Rate of level change: slow level change
- Process/measurement conditions:
 - Ice and condensation on the antenna possible
 - Spiders and insects build nests in the antennas
 - Turbulent water surface
 - Sensor flooding possible
- Properties, sensor:
 - Stable and reliable measured values through frequent averaging
 - Insensitive in the close range

Demonstration:

- Adjustment for all applications which are not typically level measurement
 - Instrument demonstration
 - Object recognition/monitoring (additional settings required)

- Properties, sensor:
 - Sensor accepts all measured value changes within the measuring range immediately
 - High sensitivity to interference, because virtually no averaging



Caution:

If liquids with different dielectric constants separate in the vessel, for example through condensation, the radar sensor can detect under certain circumstances only the medium with the higher dielectric constant. Keep in mind that layer interfaces can cause faulty measurements.

If you want to measure the total height of both liquids reliably, please contact our service department or use an instrument specially designed for interface measurement.

Setup - Vessel form

Apart from the medium and the application, the vessel form itself can influence the measurement. To adapt the sensor to these measuring conditions, this menu item offers different options for vessel bottom and ceiling for certain applications.

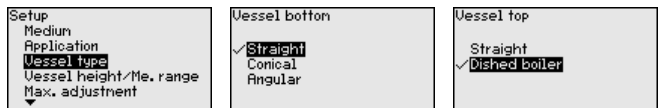

Enter the requested parameters via the appropriate keys, save your settings with **[OK]** and jump to the next menu item with the **[ESC]** and the **[->]** key.

Setup - Vessel height, measuring range

Through this selection the operating range of the sensor is adapted to the vessel height, which considerably increases measurement reliability under different basic conditions.

The min. adjustment must be carried out independently of this.

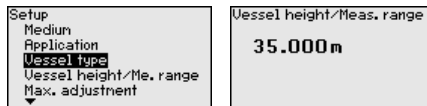

Enter the requested parameters via the appropriate keys, save your settings with **[OK]** and jump to the next menu item with the **[ESC]** and the **[->]** key.

Setup - Adjustment

Since the radar sensor is a distance measuring instrument, it is the distance from the sensor to the product surface that is measured. To indicate the actual level, the measured distance must be assigned to a certain height percentage.

To perform the adjustment, enter the distance with full and empty vessel, see the following example:

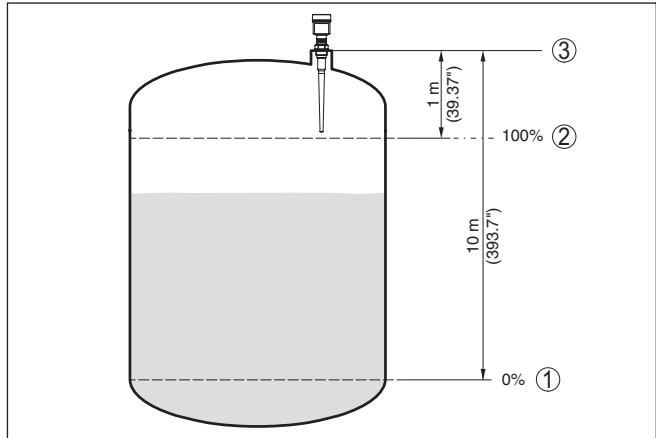

Fig. 26: Parameterisation example, Min./max. adjustment

- 1 Min. level = max. measuring distance
- 2 Max. level = min. measuring distance

If these values are not known, an adjustment with the distances of e.g. 10 % and 90 % is possible. Starting point for these distance specifications is always the sealing surface of the thread or flange. You can find further specifications on the reference plane in the chapters "Mounting instructions" and "Technical data". The actual level is calculated on the basis of these settings.

The actual product level during this adjustment is not important, because the min./max. adjustment is always carried out without changing the product level. These settings can be made ahead of time without the instrument having to be installed.

Setup - Min. adjustment

Proceed as follows:

1. Select the menu item "Setup" with [\rightarrow] and confirm with [OK].
Now select with [\rightarrow] the menu item "Min. adjustment" and confirm with [OK].

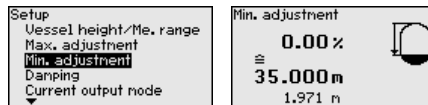

2. Edit the percentage value with [OK] and set the cursor to the requested position with [\rightarrow].

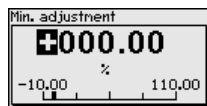

3. Set the requested percentage value with [+], and save with [OK].
The cursor jumps now to the distance value.

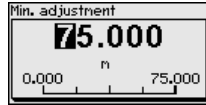

4. Enter the suitable distance value in m for empty vessel (e.g. distance from the sensor to the vessel bottom) corresponding to the percentage value.
5. Save settings with **[OK]** and move with **[ESC]** and **[->]** to the max. adjustment.

Setup - Max. adjustment

Proceed as follows:

1. Select with **[->]** the menu item Max. adjustment and confirm with **[OK]**.

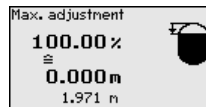
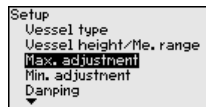

2. Prepare the percentage value for editing with **[OK]** and set the cursor to the requested position with **[->]**.

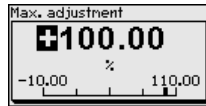

3. Set the requested percentage value with **[+]** and save with **[OK]**. The cursor jumps now to the distance value.

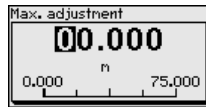

4. Enter the appropriate distance value in m (corresponding to the percentage value) for the full vessel. Keep in mind that the max. level must lie below the min. distance to the antenna edge.
5. Save settings with **[OK]**

Setup - Damping

To damp process-dependent measured value fluctuations, set an integration time of 0 ... 999 s in this menu item.

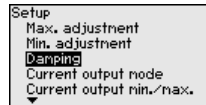
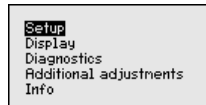

Depending on the sensor type, the factory setting is 0 s or 1 s.

Setup - Current output, mode

In the menu item "Current output mode" you determine the output characteristics and reaction of the current output in case of fault.

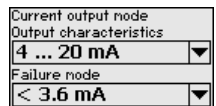
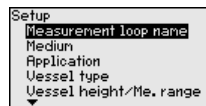
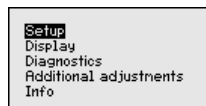

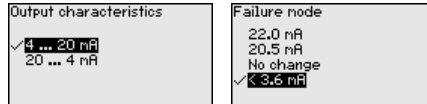

The default setting is output characteristics 4 ... 20 mA, fault mode < 3.6 mA.

Setup - Current output Min./Max.

In the menu item "Current output Min./Max.", you determine the reaction of the current output during operation.

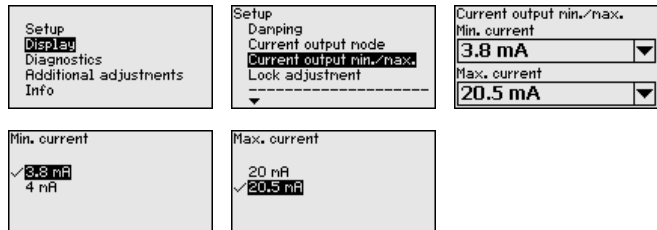

The default setting is min. current 3.8 mA and max. current 20.5 mA.

Setup - Lock adjustment

In this menu item, the PIN is activated/deactivated permanently. Entering a 4-digit PIN protects the sensor data against unauthorized access and unintentional modifications. If the PIN is activated permanently, it can be deactivated temporarily (i.e. for approx. 60 min.) in any menu item.

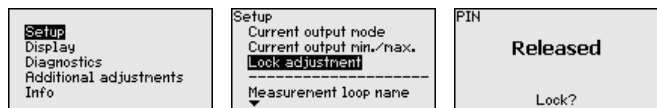

Only the following functions are permitted with activated PIN:

- Select menu items and show data
- Read data from the sensor into the display and adjustment module



Caution:

When the PIN is active, adjustment via PACTware/DTM as well as other systems is also blocked.

In delivery status, the PIN is "0000".

Display - Language

This menu item enables the setting of the requested national language.

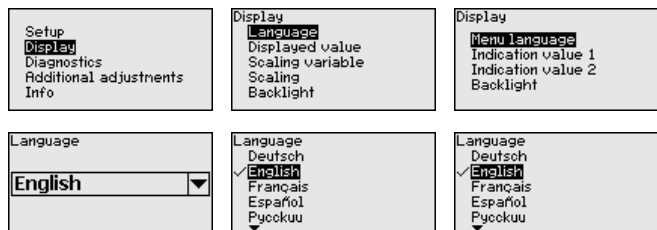

In delivery status, the sensor is set to the ordered national language.

Display - Indicated value

In this menu item you can define the indication of the measured value on the display.

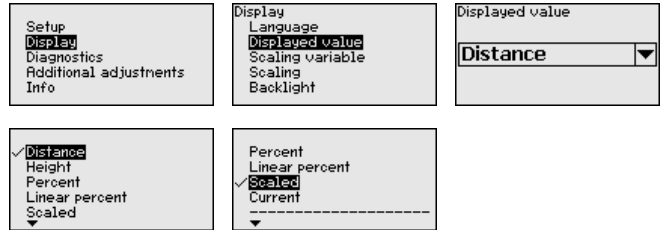

The default setting for the indicated value is e.g. "Distance" on radar sensors.

Display - Backlight

The optionally integrated background lighting can be switched on via the adjustment menu. This function depends on the level of the supply voltage, see operating instructions of the respective sensor.

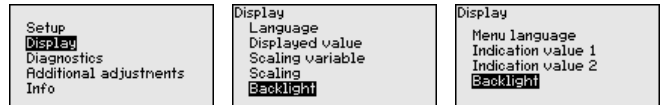

In delivery status, the lighting is switched on.

Diagnostics - Device status

In this menu item, the device status is displayed.

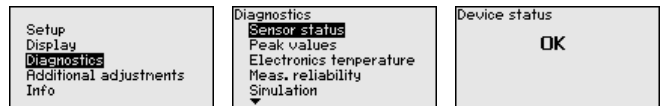

Diagnostics - Peak values (distance)

The respective min. and max. measured distance values are saved in the sensor. The values are displayed in the menu item "Peak values".

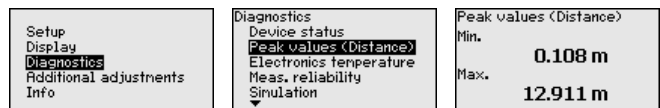

Diagnosis - Electronics temperature

The respective min. and max. measured values of the electronics temperature are saved in the sensor. These values as well as the current temperature value are displayed in the menu item "Peak values".

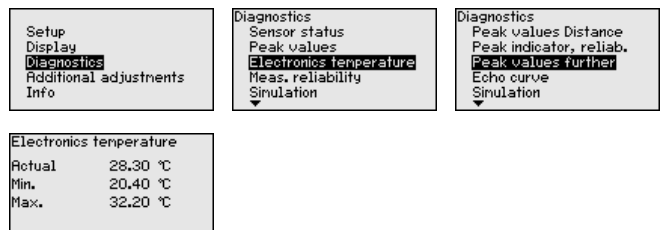

Diagnosis - Measurement reliability

When non-contact level sensors are used, the measurement can be influenced by the respective process conditions. In this menu item, the measurement reliability of the level echo is displayed as a dB value. Measurement reliability equals signal strength minus noise. The higher the value, the more reliable the measurement. A well functioning measurement normally has a value > 10 dB.

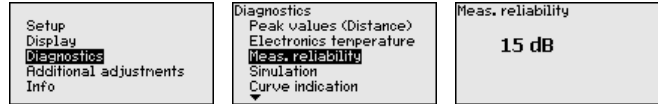

Diagnosis - Simulation

In this menu item you can simulate measured values via the current output. This allows the signal path to be tested, e.g. through downstream indicating instruments or the input card of the control system.

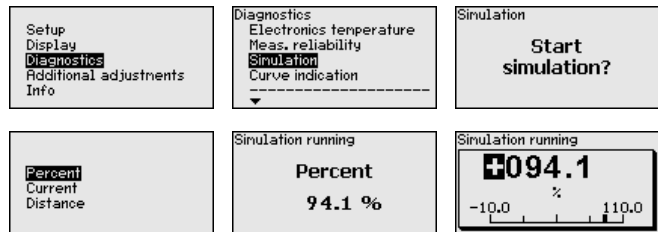

How to start the simulation:

1. Push **[OK]**
2. Select the requested simulation variable with **[>]** and confirm with **[OK]**.
3. With **[OK]** you start the simulation, first of all the actual measured value is displayed in %
4. Start the editing mode with **[OK]**
5. Set the requested numerical value with **[+]** and **[>]**.
6. Push **[OK]**



Note:

During simulation, the simulated value is output as 4 ... 20 mA current value and digital HART signal.

How to interrupt the simulation:

→ Push **[ESC]**



Information:

The simulation is automatically terminated 10 minutes after the last pressing of a key.

Diagnosis - Curve indication

The "Echo curve" shows the signal strength of the echoes over the measuring range in dB. The signal strength enables an evaluation of the quality of the measurement.

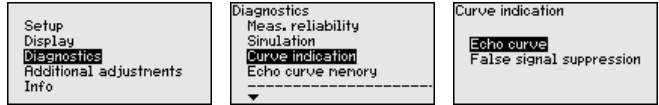

The "False signal suppression" displays the saved false echoes (see menu "Additional settings") of the empty vessel with signal strength in "dB" over the entire measuring range.

A comparison of echo curve and false signal suppression allows a more detailed statement about measurement reliability.

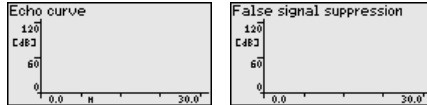

The selected curve is continuously updated. A submenu with zoom functions is opened with the [OK] key:

- "X-Zoom": Zoom function for the meas. distance
- "Y-Zoom": 1, 2, 5 and 10x signal magnification in "dB"
- "Unzoom": Reset the presentation to the nominal measuring range without magnification

Diagnostics - Echo curve memory

The function "Echo curve memory" makes it possible to save the echo curve at the time of setup. This is generally recommended, and it is absolutely necessary if you want to use the Asset Management functions. If possible, the curve should be saved with a low level in the vessel.

With the adjustment software PACTware and a PC, a high resolution echo curve can be displayed and used to recognize signal changes during operation. In addition, the echo curve of setup can be displayed in the echo curve window and compared with the current echo curve.

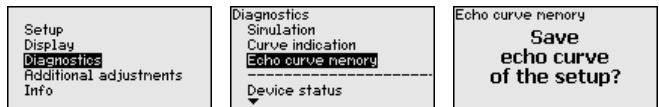

Additional adjustments - Instrument units

In this menu item you select the measured variable of the system and the temperature unit.

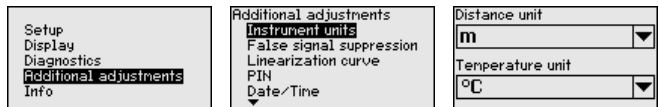

Additional settings - False signal suppression

The following circumstances cause interfering reflections and can influence the measurement:

- High mounting sockets
- Vessel internals such as struts
- Agitators
- Buildup or welded joints on vessel walls

**Note:**

A false signal suppression detects, marks and saves these false signals to ensure that they are ignored in the level measurement.

This should be done with the lowest possible level so that all potential interfering reflections can be detected.

Proceed as follows:

1. Select with [->] the menu item "*False signal suppression*" and confirm with [OK].

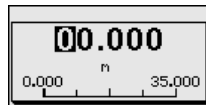
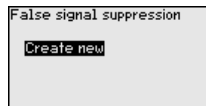
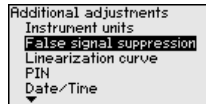

2. Confirm 3-times with [OK] and enter the actual distance from the sensor to the product surface.
3. All interfering signals in this range are detected by the sensor and stored after being confirmed with [OK].

**Note:**

Check the distance to the product surface, because if an incorrect (too large) value is entered, the existing level will be saved as a false signal. The level would then no longer be detectable in this area.

If a false signal suppression has already been saved in the sensor, the following menu window appears when selecting "*False signal suppression*":

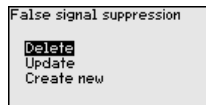

Delete: An already created false signal suppression will be completely deleted. This is useful if the saved false signal suppression no longer matches the metrological conditions in the vessel.

Extend: is used to extend an already created false signal suppression. This is useful if a false signal suppression was carried out with too high a level and not all false signals could be detected. When selecting "*Extend*", the distance to the product surface of the created false signal suppression is displayed. This value can now be changed and the false signal suppression can be extended to this range.

Additional settings - Linearization

A linearization is necessary for all vessels in which the vessel volume does not increase linearly with the level - e.g. a horizontal cylindrical

cal or spherical tank - and the indication or output of the volume is required. Corresponding linearization curves are preprogrammed for these vessels. They represent the correlation between the level percentage and vessel volume.

By activating the appropriate curve, the volume percentage of the vessel is displayed correctly. If the volume should not be displayed in percent but e.g. in l or kg, a scaling can be also set in the menu item "Display".

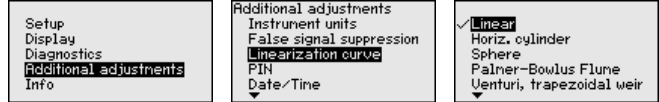

Enter the requested parameters via the appropriate keys, save your settings and jump to the next menu item with the [ESC] and [->] key.



Caution:

Note the following if instruments with appropriate approval are used as part of an overflow protection system according to WHG:

If a linearisation curve is selected, the measuring signal is no longer necessarily linear to the filling height. This must be considered by the user especially when setting the switching point on the limit signal transmitter.

Additional settings - PIN

Entering a 4-digit PIN protects the sensor data against unauthorized access and unintentional modification. In this menu item, the PIN is displayed or edited and changed. However, this menu item is only available if adjustment is enabled in the menu "Setup".

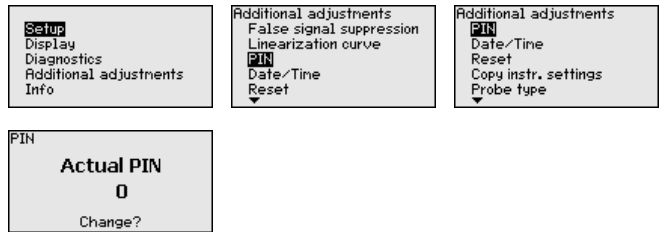

In delivery status, the PIN is "0000".

Additional settings - Date/Time

In this menu item, the internal clock of the sensor is set.

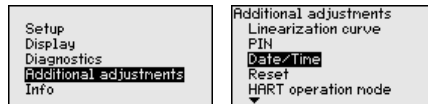

Additional settings - Reset

After a reset, certain parameter adjustments made by the user are reset.

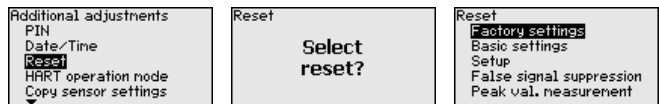

The following reset functions are available:

Delivery status: Restores the parameter settings at the time of shipment from the factory, incl. order-specific settings. Any stored false signal suppression or user-programmed linearisation curve, as well as the measured value memory, are deleted.

Basic settings: Restores the parameter settings, incl. special parameters, to the default values of the respective instrument. Any stored false signal suppression or user-programmed linearisation curve, as well as the measured value memory, are deleted.

Setup: Restores the parameter settings made in the menu item Setup to the default values of the respective instrument. False signal suppression, user-programmed linearisation curve, measured value memory and event memory remain untouched. The linearisation is set to linear.

False signal suppression: Deletes a previously created false signal suppression. The false signal suppression created at the factory remains active.

Peak values, measured value: Resets the measured min. and max. distances to the current measured value.

The following table shows the default values of the instrument. Depending on the instrument version, not all menu items are available or some may be differently assigned:

Menu	Menu item	Default value
Setup	Measurement loop name	Sensor
	Medium	Liquid/Water Bulk solids/Crushed stones, gravel
	Application	Storage tank Silo
	Vessel form	Vessel bottom, dished form Vessel top, dished form
	Vessel height/Measuring range	Recommended measuring range, see " <i>Technical data</i> " in the supplement.
	Min. adjustment	Recommended measuring range, see " <i>Technical data</i> " in the supplement.
	Max. adjustment	0,000 m(d)
	Damping	0.0 s
	Current output mode	4 ... 20 mA, < 3.6 mA
	Current output, min./max.	Min. current 3.8 mA, max. current 20.5 mA
	Lock adjustment	Released

Menu	Menu item	Default value
Display	Language	Like order
	Displayed value	Distance
	Display unit	m
	Scaling size	Volume l
	Scaling	0.00 lin %, 0 l 100.00 lin %, 100 l
	Backlight	Switched on
Additional adjustments	Distance unit	m
	Temperature unit	°C
	Probe length	Length of standpipe ex factory
	Linearisation curve	Linear
	HART mode	Standard Address 0

Additional settings - HART mode

The sensor offers the HART modes standard and Multidrop. In this menu item you specify the HART mode and enter the address for Multidrop.

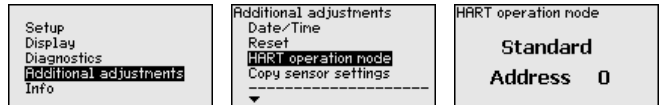

The mode "standard" with the fixed address 0 means outputting the measured value as a 4 ... 20 mA signal.

In Multidrop mode, up to 63 sensors can be operated on one two-wire cable. An address between 1 and 63 must be assigned to each sensor.¹⁾

The default setting is standard with address 0.

Additional settings - Copy instrument settings

The instrument settings are copied with this function. The following functions are available:

- Store data from sensor in the display and adjustment module.
- Store data from display and adjustment module in the sensor

The following data or settings for adjustment of the display and adjustment module are saved:

- All data of the menu "Setup" and "Display"
- In the menu "Additional settings" the items "Distance unit, temperature unit and linearization"
- The values of the user-programmable linearisation curve

¹⁾ The 4 ... 20 mA signal of the sensor is switched off. The sensor uses a constant current of 4 mA. The measuring signal is transmitted exclusively as a digital HART signal.

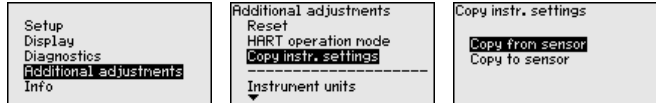

The copied data are permanently saved in an EEPROM memory in the display and adjustment module and remain there even in case of power failure. From there, they can be written into one or more sensors or kept as backup for a possible sensor exchange.

The type and the volume of the copied data depend on the respective sensor.



Note:

Before the data are stored in the sensor, a check is carried out to determine if the data fit the sensor. If the data do not fit, a fault signal is triggered or the function is blocked. When data are being written into the sensor, the display shows which instrument type the data originate from and which TAG-no. this sensor had.

Info - Instrument name

In this menu, you read out the instrument name and the instrument serial number:

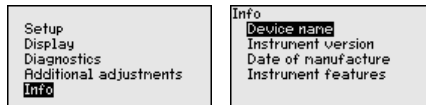

Info - Instrument version

In this menu item, the hardware and software version of the sensor is displayed.

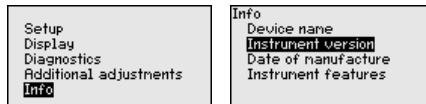

Info - Date of manufacture

In this menu item, the date of factory calibration of the sensor as well as the date of the last change of sensor parameters are displayed via the display and adjustment module or via the PC.

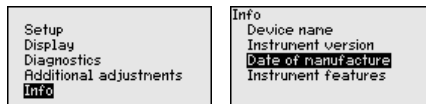

Instrument features

In this menu item, the features of the sensor such as approval, process fitting, seal, measuring range, electronics, housing and others are displayed.

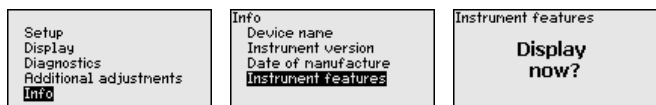

6.5 Saving the parameterisation data

On paper

We recommended writing down the adjustment data, e.g. in this operating instructions manual, and archiving them afterwards. They are thus available for multiple use or service purposes.

In the display and adjustment module

If the instrument is equipped with a display and adjustment module, the parameter adjustment data can be saved therein. The procedure is described in menu item "*Copy device settings*".

7 Setup with PACTware

7.1 Connect the PC

Via the interface adapter directly on the sensor

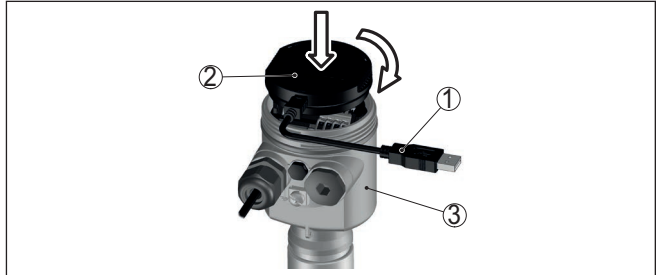

Fig. 27: Connection of the PC directly to the sensor via the interface adapter

- 1 USB cable to the PC
- 2 Interface adapter VEGACONNECT
- 3 Sensor

Via the interface adapter and HART

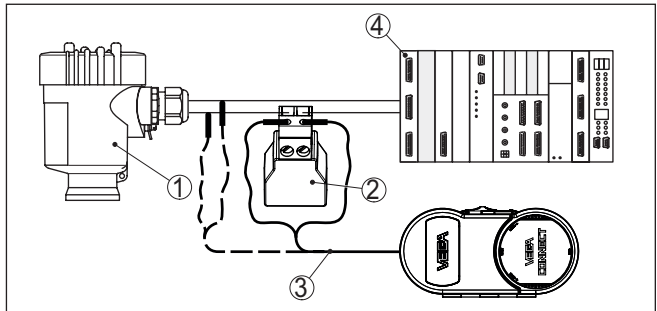

Fig. 28: Connecting the PC via HART to the signal cable

- 1 Sensor
- 2 HART resistance 250 Ω (optional depending on evaluation)
- 3 Connection cable with 2 mm pins and terminals
- 4 Processing system/PLC/Voltage supply
- 5 Interface adapter, for example VEGACONNECT 4



Note:

With power supply units with integrated HART resistance (internal resistance approx. 250 Ω), an additional external resistance is not necessary. This applies, e.g. to the VEGA instruments VEGATRENN 149A, VEGAMET 381, VEGAMET 391. Common Ex separators are also usually equipped with a sufficient current limiting resistance. In such cases, the interface converter can be connected parallel to the 4 ... 20 mA cable (dashed line in the previous illustration).

7.2 Parameter adjustment

Prerequisites

For parameter adjustment of the instrument via a Windows PC, the configuration software PACTware and a suitable instrument driver

(DTM) according to FDT standard are required. The latest PACTware version as well as all available DTMs are compiled in a DTM Collection. The DTMs can also be integrated into other frame applications according to FDT standard.



Note:

To ensure that all instrument functions are supported, you should always use the latest DTM Collection. Furthermore, not all described functions are included in older firmware versions. You can download the latest instrument software from our homepage. A description of the update procedure is also available in the Internet.

Further setup steps are described in the operating instructions manual "DTM Collection/PACTware" attached to each DTM Collection and which can also be downloaded from the Internet. Detailed descriptions are available in the online help of PACTware and the DTMs.

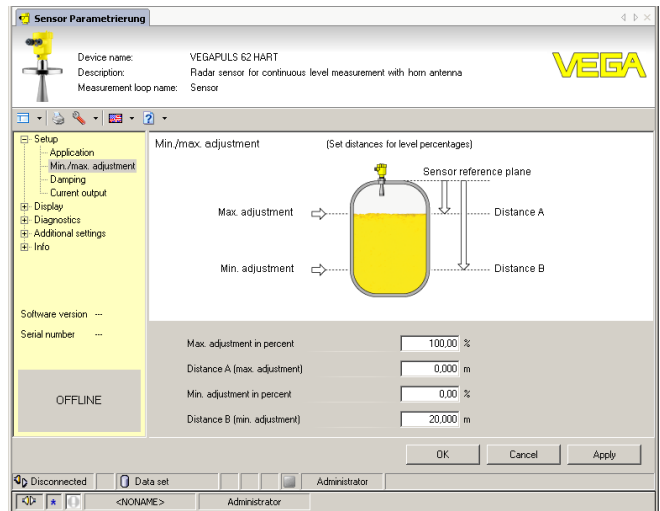

Fig. 29: Example of a DTM view

Standard/Full version

All device DTMs are available as a free-of-charge standard version and as a full version that must be purchased. In the standard version, all functions for complete setup are already included. An assistant for simple project configuration simplifies the adjustment considerably. Saving/printing the project as well as import/export functions are also part of the standard version.

In the full version there is also an extended print function for complete project documentation as well as a save function for measured value and echo curves. In addition, there is a tank calculation program as well as a multiviewer for display and analysis of the saved measured value and echo curves.

The standard version is available as a download under www.vega.com/downloads and "Software". The full version is available on CD from the agency serving you.

7.3 Saving the parameterisation data

We recommend documenting or saving the parameterisation data via PACTware. That way the data are available for multiple use or service purposes.

8 Set up with other systems

8.1 DD adjustment programs

Device descriptions as Enhanced Device Description (EDD) are available for DD adjustment programs such as, for example, AMS™ and PDM.

The files can be downloaded at www.vega.com/downloads under "Software".

8.2 Field Communicator 375, 475

Device descriptions for the instrument are available as EDD for parameterisation with Field Communicator 375 or 475.

Integrating the EDD into the Field Communicator 375 or 475 requires the "Easy Upgrade Utility" software, which is available from the manufacturer. This software is updated via the Internet and new EDDs are automatically accepted into the device catalogue of this software after they are released by the manufacturer. They can then be transferred to a Field Communicator.

9 Diagnosis, asset management and service

9.1 Maintenance

Maintenance

If the device is used properly, no special maintenance is required in normal operation.

Cleaning

The cleaning helps that the type label and markings on the instrument are visible.

Take note of the following:

- Use only cleaning agents which do not corrode the housings, type label and seals
- Use only cleaning methods corresponding to the housing protection rating

9.2 Measured value and event memory

The instrument has several memories available for diagnostic purposes. The data remain there even in case of voltage interruption.

Measured value memory

Up to 100,000 measured values can be stored in the sensor in a ring memory. Each entry contains date/time as well as the respective measured value. Storable values are for example:

- Distance
- Filling height
- Percentage value
- Lin. percent
- Scaled
- Current value
- Measurement reliability
- Electronics temperature

When the instrument is shipped, the measured value memory is active and stores distance, measurement reliability and electronics temperature every 3 minutes.

The requested values and recording conditions are set via a PC with PACTware/DTM or the control system with EDD. Data are thus read out and also reset.

Event memory

Up to 500 events are automatically stored with a time stamp in the sensor (non-deletable). Each entry contains date/time, event type, event description and value. Event types are for example:

- Modification of a parameter
- Switch-on and switch-off times
- Status messages (according to NE 107)
- Error messages (according to NE 107)

The data are read out via a PC with PACTware/DTM or the control system with EDD.

Echo curve memory

The echo curves are stored with date and time and the corresponding echo data. The memory is divided into two sections:

Echo curve of the setup: This is used as reference echo curve for the measurement conditions during setup. Changes in the measurement conditions during operation or buildup on the sensor can thus be recognized. The echo curve of the setup is stored via:

- PC with PACTware/DTM
- Control system with EDD
- Display and adjustment module

Further echo curves: Up to 10 echo curves can be stored in a ring buffer in this memory section. Additional echo curves are stored via:

- PC with PACTware/DTM
- Control system with EDD

9.3 Asset Management function

The instrument features self-monitoring and diagnostics according to NE 107 and VDI/VDE 2650. In addition to the status messages in the following tables, detailed error messages are available under menu item "Diagnostics" via the display and adjustment module, PACTware/DTM and EDD.

Status messages

The status messages are divided into the following categories:

- Failure
- Function check
- Out of specification
- Maintenance requirement

and explained by pictographs:

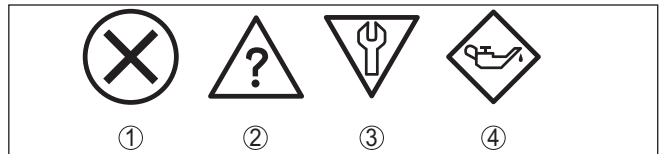

Fig. 30: Pictographs of the status messages

- 1 Failure - red
- 2 Out of specification - yellow
- 3 Function check - orange
- 4 Maintenance - blue

Failure: Due to a malfunction in the instrument, a fault message is output.

This status message is always active. It cannot be deactivated by the user.

Function check: The instrument is being worked on, the measured value is temporarily invalid (for example during simulation).

This status message is inactive by default. It can be activated by the user via PACTware/DTM or EDD.

Out of specification: The measured value is unreliable because an instrument specification was exceeded (e.g. electronics temperature).

This status message is inactive by default. It can be activated by the user via PACTware/DTM or EDD.

Maintenance: Due to external influences, the instrument function is limited. The measurement is affected, but the measured value is still valid. Plan in maintenance for the instrument because a failure is expected in the near future (e.g. due to buildup).

This status message is inactive by default. It can be activated by the user via PACTware/DTM or EDD.

Failure

Code Text message	Cause	Rectification	DevSpec State in CMD 48
F013 no measured value available	<ul style="list-style-type: none"> ● Sensor does not detect an echo during operation ● Antenna system dirty or defective 	<ul style="list-style-type: none"> ● Check or correct installation and/or parameter settings ● Clean or exchange process component or antenna 	Bit 0 of Byte 0 ... 5
F017 Adjustment span too small	<ul style="list-style-type: none"> ● Adjustment not within specification 	<ul style="list-style-type: none"> ● Change adjustment according to the limit values (difference between min. and max. ≥ 10 mm) 	Bit 1 of Byte 0 ... 5
F025 Error in the linearization table	<ul style="list-style-type: none"> ● Index markers are not continuously rising, for example illogical value pairs 	<ul style="list-style-type: none"> ● Check linearisation table ● Delete table/Create new 	Bit 2 of Byte 0 ... 5
F036 No operable software	<ul style="list-style-type: none"> ● Failed or interrupted software update 	<ul style="list-style-type: none"> ● Repeat software update ● Check electronics version ● Exchanging the electronics ● Send instrument for repair 	Bit 3 of Byte 0 ... 5
F040 Error in the electronics	<ul style="list-style-type: none"> ● Hardware defect 	<ul style="list-style-type: none"> ● Exchanging the electronics ● Send instrument for repair 	Bit 4 of Byte 0 ... 5
F080 General software error	<ul style="list-style-type: none"> ● General software error 	<ul style="list-style-type: none"> ● Disconnect operating voltage briefly 	Bit 5 of Byte 0 ... 5
F105 Determine measured value	<ul style="list-style-type: none"> ● The instrument is still in the start phase, the measured value could not yet be determined 	<ul style="list-style-type: none"> ● Wait for the end of the switch-on phase ● Duration up to approx. 3 minutes depending on the version and parameter settings 	Bit 6 of Byte 0 ... 5
F113 Communication error	<ul style="list-style-type: none"> ● EMC interference ● Transmission error during external communication with 4-wire power supply unit 	<ul style="list-style-type: none"> ● Remove EMC influences 	Bit 12 of Byte 0 ... 5
F125 Impermissible electronics temperature	<ul style="list-style-type: none"> ● Temperature of the electronics in the non-specified range 	<ul style="list-style-type: none"> ● Check ambient temperature ● Insulate electronics ● Use instrument with higher temperature range 	Bit 7 of Byte 0 ... 5
F260 Error in the calibration	<ul style="list-style-type: none"> ● Error in the calibration carried out in the factory ● Error in the EEPROM 	<ul style="list-style-type: none"> ● Exchanging the electronics ● Send instrument for repair 	Bit 8 of Byte 0 ... 5

Code Text message	Cause	Rectification	DevSpec State in CMD 48
F261 Error in the instrument settings	<ul style="list-style-type: none"> ● Error during setup ● False signal suppression faulty ● Error when carrying out a reset 	<ul style="list-style-type: none"> ● Repeat setup ● Carry out a reset 	Bit 9 of Byte 0 ... 5
F264 Installation/Setup error	<ul style="list-style-type: none"> ● Adjustment not within the vessel height/measuring range ● Max. measuring range of the instrument not sufficient 	<ul style="list-style-type: none"> ● Check or correct installation and/or parameter settings ● Use an instrument with bigger measuring range 	Bit 10 of Byte 0 ... 5
F265 Measurement function disturbed	<ul style="list-style-type: none"> ● Sensor no longer carries out a measurement ● Operating voltage too low 	<ul style="list-style-type: none"> ● Check operating voltage ● Carry out a reset ● Disconnect operating voltage briefly 	Bit 11 of Byte 0 ... 5

Function check

Code Text message	Cause	Rectification	DevSpec State in CMD 48
C700 Simulation active	<ul style="list-style-type: none"> ● A simulation is active 	<ul style="list-style-type: none"> ● Finish simulation ● Wait for the automatic end after 60 mins. 	"Simulation Active" in "Standardized Status 0"

Out of specification

Code Text message	Cause	Rectification	DevSpec State in CMD 48
S600 Impermissible electronics temperature	<ul style="list-style-type: none"> ● Temperature of the electronics in the non-specified range 	<ul style="list-style-type: none"> ● Check ambient temperature ● Insulate electronics ● Use instrument with higher temperature range 	Bit 5 of Byte 14 ... 24
S601 Overfilling	<ul style="list-style-type: none"> ● Danger of vessel overfilling 	<ul style="list-style-type: none"> ● Make sure that there is no further filling ● Check level in the vessel 	Bit 6 of Byte 14 ... 24

Tab. 7: Error codes and text messages, information on causes as well as corrective measures

Maintenance

Code Text message	Cause	Rectification	DevSpec State in CMD 48
M500 Error during the reset "delivery status"	<ul style="list-style-type: none"> ● The data could not be restored during the reset to delivery status 	<ul style="list-style-type: none"> ● Repeat reset ● Load XML file with sensor data into the sensor 	Bit 0 of Byte 14 ... 24
M501 Error in the non-active linearisation table	<ul style="list-style-type: none"> ● Hardware error EEPROM 	<ul style="list-style-type: none"> ● Exchanging the electronics ● Send instrument for repair 	Bit 1 of Byte 14 ... 24
M502 Error in the diagnostics memory	<ul style="list-style-type: none"> ● Hardware error EEPROM 	<ul style="list-style-type: none"> ● Exchanging the electronics ● Send instrument for repair 	Bit 2 of Byte 14 ... 24

Code Text message	Cause	Rectification	DevSpec State in CMD 48
M503 Measurement reliability too low	<ul style="list-style-type: none"> ● The echo/noise ratio is too small for reliable measurement 	<ul style="list-style-type: none"> ● Check installation and process conditions ● Clean the antenna ● Change polarisation direction ● Use instrument with higher sensitivity 	Bit 3 of Byte 14 ... 24
M504 Error at a device interface	<ul style="list-style-type: none"> ● Hardware defect 	<ul style="list-style-type: none"> ● Check connections ● Exchanging the electronics ● Send instrument for repair 	Bit 4 of Byte 14 ... 24
M505 No echo available	<ul style="list-style-type: none"> ● Level echo can no longer be detected 	<ul style="list-style-type: none"> ● Clean the antenna ● Use a more suitable antenna/sensor ● Remove possible false echoes ● Optimize sensor position and orientation 	Bit 7 of Byte 14 ... 24

Tab. 8: Error codes and text messages, information on causes as well as corrective measures

9.4 Rectify faults

Reaction when malfunction occurs

The operator of the system is responsible for taking suitable measures to rectify faults.

Procedure for fault rectification

The first measures are:

- Evaluation of fault messages via the adjustment device
- Checking the output signal
- Treatment of measurement errors

Further comprehensive diagnostics options are available with a PC with PACTware and the suitable DTM. In many cases, the reasons can be determined in this way and faults rectified.

Check the 4 ... 20 mA signal

Connect a multimeter in the suitable measuring range according to the wiring plan. The following table describes possible errors in the current signal and helps to eliminate them:

Error	Cause	Rectification
4 ... 20 mA signal not stable	<ul style="list-style-type: none"> ● Fluctuating measured value 	<ul style="list-style-type: none"> ● Set damping
4 ... 20 mA signal missing	<ul style="list-style-type: none"> ● Electrical connection faulty 	<ul style="list-style-type: none"> ● Check connection, correct, if necessary
	<ul style="list-style-type: none"> ● Voltage supply missing 	<ul style="list-style-type: none"> ● Check cables for breaks; repair if necessary
	<ul style="list-style-type: none"> ● Operating voltage too low, load resistance too high 	<ul style="list-style-type: none"> ● Check, adapt if necessary
Current signal greater than 22 mA, less than 3.6 mA	<ul style="list-style-type: none"> ● Sensor electronics defective 	<ul style="list-style-type: none"> ● Exchange the instrument or send it in for repair

Treatment of measurement errors with liquids

The below tables show typical examples of application-related measurement errors with liquids. The measurement errors are differentiated according to the following:

- Constant level
- Filling
- Emptying

The images in column "Error pattern" show the real level as a broken line and the level displayed by the sensor as a continuous line.

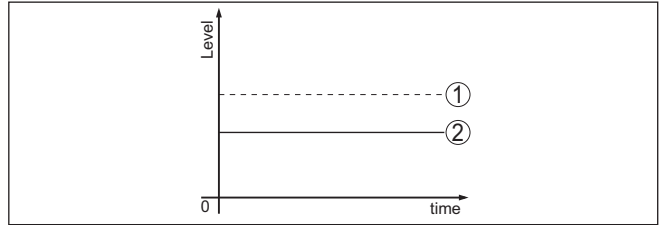

- 1 Real level
- 2 Level displayed by the sensor

Notes:

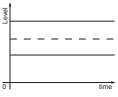
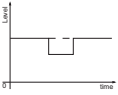
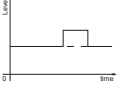

- Wherever the sensor displays a constant value, the reason could also be the fault setting of the current output to "Hold value"
- If the level indication is too low, the reason could be a line resistance that is too high

Measurement error with constant level

Fault description	Cause	Rectification
1. Measured value shows a too low or too high level 	● Min./max. adjustment not correct	● Adapt min./max. adjustment
	● Incorrect linearisation curve	● Adapt linearisation curve
	● Installation in a bypass tube or standpipe, hence running time error (small measurement error close to 100 %/large error close to 0 %)	● Check parameter "Application" with respect to vessel form, adapt if necessary (bypass, standpipe, diameter)
2. Measured value jumps towards 0 % 	● Multiple echo (vessel top, product surface) with amplitude higher than the level echo	● Check parameter "Application", especially vessel top, type of medium, dished bottom, high dielectric constant, and adapt if necessary
3. Measured value jumps towards 100 % 	● Due to the process, the amplitude of the level echo sinks ● A false signal suppression was not carried out	● Carry out a false signal suppression
	● Amplitude or position of a false signal has changed (e.g. condensation, buildup); false signal suppression no longer matches actual conditions	● Determine the reason for the changed false signals, carry out false signal suppression, e.g. with condensation

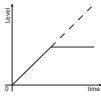

36515-EN-181127

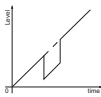
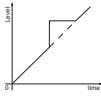
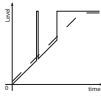
Measurement error during filling

Fault description	Cause	Rectification
<p>4. Measured value remains unchanged during filling</p> 	<ul style="list-style-type: none"> ● False signals in the close range too big or level echo too small ● Strong foam or spout generation ● Max. adjustment not correct 	<ul style="list-style-type: none"> ● Eliminate false signals in the close range ● Check measurement situation: Antenna must protrude out of the socket, installations ● Remove contamination on the antenna ● In case of interferences due to installations in the close range: Change polarisation direction ● Create a new false signal suppression ● Adapt max. adjustment
<p>5. Measured value remains in the bottom section during filling</p> 	<ul style="list-style-type: none"> ● Echo from the tank bottom larger than the level echo, for example, with products with $\epsilon_r < 2.5$ oil-based, solvents 	<ul style="list-style-type: none"> ● Check parameters Medium, Vessel height and Floor form, adapt if necessary
<p>6. Measured value remains momentarily unchanged during filling and then jumps to the correct level</p> 	<ul style="list-style-type: none"> ● Turbulence on the product surface, quick filling 	<ul style="list-style-type: none"> ● Check parameters, change if necessary, e.g. in dosing vessel, reactor
<p>7. Measured value jumps towards 0 % during filling</p> 	<ul style="list-style-type: none"> ● Amplitude of a multiple echo (vessel top - product surface) is larger than the level echo ● The level echo cannot be distinguished from the false signal at a false signal position (jumps to multiple echo) 	<ul style="list-style-type: none"> ● Check parameter "Application", especially vessel top, type of medium, dished bottom, high dielectric constant, and adapt if necessary ● In case of interferences due to installations in the close range: Change polarisation direction ● Chose a more suitable installation position
<p>8. Measured value jumps towards 100 % during filling</p> 	<ul style="list-style-type: none"> ● Due to strong turbulence and foam generation during filling, the amplitude of the level echo sinks. Measured value jumps to false signal 	<ul style="list-style-type: none"> ● Carry out a false signal suppression
<p>9. Measured value jumps sporadically to 100 % during filling</p> 	<ul style="list-style-type: none"> ● Varying condensation or contamination on the antenna 	<ul style="list-style-type: none"> ● Carry out a false signal suppression or increase false signal suppression with condensation/contamination in the close range by editing

Fault description	Cause	Rectification
<p>10. Measured value jumps to $\geq 100\%$ or 0 m distance</p> 	<ul style="list-style-type: none"> ● Level echo is no longer detected in the close range due to foam generation or false signals in the close range. The sensor goes into overflow protection mode. The max. level (0 m distance) as well as the status message "Overflow protection" are output. 	<ul style="list-style-type: none"> ● Check measuring site: Antenna must protrude out of the socket ● Remove contamination on the antenna ● Use a sensor with a more suitable antenna

Measurement error during emptying

Fault description	Cause	Rectification
<p>11. Measured value remains unchanged in the close range during emptying</p> 	<ul style="list-style-type: none"> ● False signal larger than the level echo ● Level echo too small 	<ul style="list-style-type: none"> ● Eliminate false signal in the close range. Check: Antenna must protrude from the socket ● Remove contamination on the antenna ● In case of interferences due to installations in the close range: Change polarisation direction ● After eliminating the false signals, the false signal suppression must be deleted. Carry out a new false signal suppression
<p>12. Measured value jumps towards 0 % during emptying</p> 	<ul style="list-style-type: none"> ● Echo from the tank bottom larger than the level echo, for example, with products with $\epsilon_r < 2.5$ oil-based, solvents 	<ul style="list-style-type: none"> ● Check parameters Medium type, Vessel height and Floor form, adapt if necessary
<p>13. Measured value jumps sporadically towards 100 % during emptying</p> 	<ul style="list-style-type: none"> ● Varying condensation or contamination on the antenna 	<ul style="list-style-type: none"> ● Carry out false signal suppression or increase false signal suppression in the close range by editing ● With bulk solids, use radar sensor with purging air connection

Reaction after fault rectification

Depending on the reason for the fault and the measures taken, the steps described in chapter "Setup" must be carried out again or must be checked for plausibility and completeness.

24 hour service hotline

Should these measures not be successful, please call in urgent cases the VEGA service hotline under the phone no. **+49 1805 858550**.

The hotline is also available outside normal working hours, seven days a week around the clock.

Since we offer this service worldwide, the support is provided in English. The service itself is free of charge, the only costs involved are the normal call charges.

9.5 Exchanging the electronics module

If the electronics module is defective, it can be replaced by the user.



In Ex applications, only instruments and electronics modules with appropriate Ex approval may be used.

If there is no electronics module available on site, the electronics module can be ordered through the agency serving you. The electronics modules are adapted to the respective sensor and differ in signal output or voltage supply.

The new electronics module must be loaded with the default settings of the sensor. These are the options:

- In the factory
- Or on site by the user

In both cases, the serial number of the sensor is needed. The serial numbers are stated on the type label of the instrument, on the inside of the housing as well as on the delivery note.

When loading on site, the order data must first be downloaded from the Internet (see operating instructions "*Electronics module*").



Caution:

All application-specific settings must be entered again. That's why you have to carry out a fresh setup after exchanging the electronics.

If you saved the parameter settings during the first setup of the sensor, you can transfer them to the replacement electronics module. A fresh setup is then not necessary.

9.6 Software update

The device software can be updated in the following ways:

- Interface adapter VEGACONNECT
- HART signal
- Bluetooth

Depending on the method, the following components are required:

- Instrument
- Voltage supply
- Interface adapter VEGACONNECT
- Display and adjustment module PLICSCOM with Bluetooth function
- PC with PACTware/DTM and Bluetooth USB adapter
- Current instrument software as file

You can find the current instrument software as well as detailed information on the procedure in the download area of our homepage: www.vega.com.



Caution:

Instruments with approvals can be bound to certain software versions. Therefore make sure that the approval is still effective after a software update is carried out.

You can find detailed information in the download area at www.vega.com.

9.7 How to proceed if a repair is necessary

You can find an instrument return form as well as detailed information about the procedure in the download area of our homepage: www.vega.com. By doing this you help us carry out the repair quickly and without having to call back for needed information.

In case of repair, proceed as follows:

- Print and fill out one form per instrument
- Clean the instrument and pack it damage-proof
- Attach the completed form and, if need be, also a safety data sheet outside on the packaging
- Ask the agency serving you to get the address for the return shipment. You can find the agency on our home page www.vega.com.

10 Dismount

10.1 Dismounting steps

**Warning:**

Before dismantling, be aware of dangerous process conditions such as e.g. pressure in the vessel or pipeline, high temperatures, corrosive or toxic products etc.

Take note of chapters "*Mounting*" and "*Connecting to voltage supply*" and carry out the listed steps in reverse order.

10.2 Disposal

The instrument consists of materials which can be recycled by specialised recycling companies. We use recyclable materials and have designed the electronics to be easily separable.

WEEE directive

The instrument does not fall in the scope of the EU WEEE directive. Article 2 of this Directive exempts electrical and electronic equipment from this requirement if it is part of another instrument that does not fall in the scope of the Directive. These include stationary industrial plants.

Pass the instrument directly on to a specialised recycling company and do not use the municipal collecting points.

If you have no way to dispose of the old instrument properly, please contact us concerning return and disposal.

11 Supplement

11.1 Technical data

Note for approved instruments

The technical data in the respective safety instructions are valid for approved instruments (e.g. with Ex approval). These data can differ from the data listed herein - for example regarding the process conditions or the voltage supply.

General data

316L corresponds to 1.4404 or 1.4435

Materials, wetted parts

- | | |
|---|------------------------------|
| - Process fitting - thread, flange | PVDF, 316L, 316L PTFE plated |
| - Process seal - Thread PVDF | FKM (Spaeh FPM70) |
| - Process seal - Thread 316L | Klingsil C-4400 (attached) |
| - Antenna for sockets 50 mm (1.969 in) | PVDF, PTFE |
| - Antenna for sockets 100 mm (3.937 in) and 250 mm (9.843 in) | PTFE |

Materials, non-wetted parts

- | | |
|-----------------------------------|--|
| - Plastic housing | Plastic PBT (Polyester) |
| - Aluminium die-cast housing | Aluminium die-casting AlSi10Mg, powder-coated (Basis: Polyester) |
| - Stainless steel housing | 316L |
| - Cable gland | PA, stainless steel, brass |
| - Sealing, cable gland | NBR |
| - Blind plug, cable gland | PA |
| - Seal, housing lid | Silicone SI 850 R, NBR silicone-free |
| - Inspection window housing cover | Polycarbonate (UL-746-C listed), glass ²⁾ |
| - Ground terminal | 316L |

Conductive connection Between ground terminal and metallic process fitting

Process fittings

- | | |
|---|--|
| - Pipe thread, cylindrical (ISO 228 T1) | G1½ according to DIN 3852-A with 316L; G1½ similar to DIN 3852-A-B with PVDF |
| - Pipe thread, conically | 1½ NPT |
| - Flanges | DIN from DN 25, ASME from 1" |

Weight 2 ... 15.4 kg (4.409 ... 33.95 lbs)

Torques

Max. torques, threaded version

- | | |
|-------|----------------------|
| - G1½ | 30 Nm (22.13 lbf ft) |
|-------|----------------------|

Required torque of the flange screws 60 Nm (44.25 lbf ft)

Recommended torque for tightening the flange screws 60 ... 100 Nm (44.25 ... 73.76 lbf ft)

²⁾ Glass with Aluminium and stainless steel precision casting housing

Max. torque for NPT cable glands and Conduit tubes

- Plastic housing 10 Nm (7.376 lbf ft)
- Aluminium/Stainless steel housing 50 Nm (36.88 lbf ft)

Input variable

Measured variable

The measured quantity is the distance between the end of the sensor antenna and the product surface. The reference plane for the measurement is the sealing surface of the thread or the lower side of the flange.

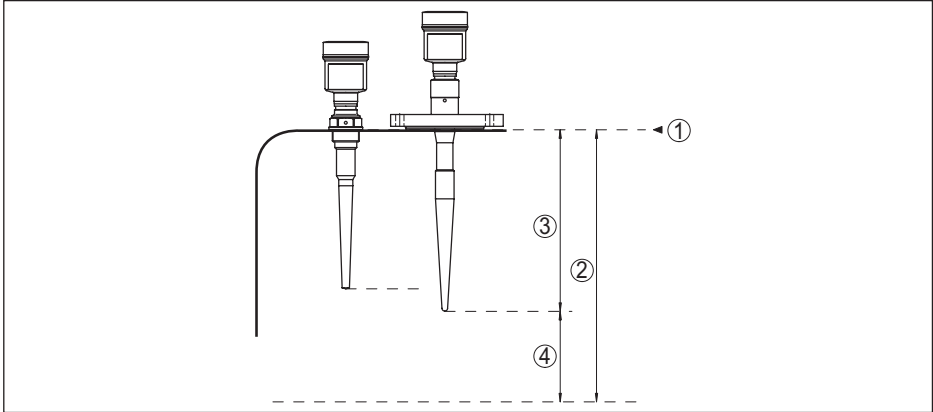

Fig. 45: Data of the input variable

- 1 Reference plane
- 2 Measured variable, max. measuring range
- 3 Antenna length
- 4 Utilisable measuring range

- Max. measuring range 35 m (114.83 ft)
- Recommended measuring range up to 10 m (32.81 ft)

Output variable

- Output signal 4 ... 20 mA/HART
- Range of the output signal 3.8 ... 20.5 mA/HART (default setting)
- Signal resolution 0.3 μ A
- Resolution, digital 1 mm (0.039 in)
- Fault signal, current output (adjustable) mA-value unchanged 20.5 mA, 22 mA, < 3.6 mA
- Max. output current 22 mA
- Load See load resistance under Power supply
- Starting current \leq 3.6 mA; \leq 10 mA for 5 ms after switching on
- Damping (63 % of the input variable), adjustable 0 ... 999 s

HART output values according to HART 7.0³⁾

- PV (Primary Value) Distance
- SV (Secondary Value) Percent
- TV (Third Value) Lin. percent
- QV (Fourth Value) Scaled

Fulfilled HART specification 7.0

Further information on Manufacturer ID, Device ID, Device Revision See website of HART Communication Foundation

Deviation (according to DIN EN 60770-1)

Process reference conditions according to DIN EN 61298-1

- Temperature +18 ... +30 °C (+64 ... +86 °F)
- Relative humidity 45 ... 75 %
- Air pressure 860 ... 1060 mbar/86 ... 106 kPa (12.5 ... 15.4 psig)

Installation reference conditions

- Min. distance to internal installations > 200 mm (7.874 in)
- Reflector Flat plate reflector
- False reflections Biggest false signal, 20 dB smaller than the useful signal

Deviation with liquids ≤ 10 mm (meas. distance > 1.0 m/3.280 ft)

Non-repeatability⁴⁾ ≤ 1 mm

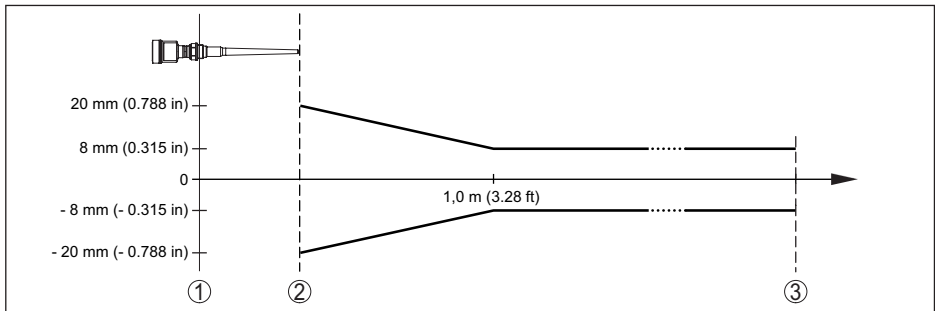

Fig. 46: Deviation under reference conditions

- 1 Reference plane
- 2 Antenna edge
- 3 Recommended measuring range

Variables influencing measurement accuracy

Specifications apply to the digital measured value

Temperature drift - Digital output < 3 mm/10 K, max. 10 mm

Specifications apply also to the current output

Temperature drift - Current output < 0.03 %/10 K relating to the 16 mA span or ≤ 0.3 %

³⁾ Default values can be assigned individually.

⁴⁾ Already included in the meas. deviation

Deviation in the current output due to digital/analogue conversion < 15 μA

Additional deviation through electromagnetic interference

- According to NAMUR NE 21 < 80 μA
- According to EN 61326-1 None
- According to IACS E10 (shipbuilding)/ IEC 60945 < 250 μA

Characteristics and performance data

Measuring frequency	C-band (6 GHz technology)
Measuring cycle time approx.	350 ms
Step response time ⁵⁾	≤ 3 s
Beam angle ⁶⁾	24°
Emitted HF power (depending on the parameter setting) ⁷⁾	
- Average spectral transmission power density	-31 dBm/MHz EIRP
- Max. spectral transmission power density	+24 dBm/50 MHz EIRP
- Specific absorption rate (SAR)	0.47 mW/kg

Ambient conditions

Ambient, storage and transport temperature -40 ... +80 °C (-40 ... +176 °F)

Process conditions

For the process conditions, please also note the specifications on the type label. The lower value always applies.

Process temperature (measured on the process fitting)

- Process fitting, thread PVDF -40 ... +130 °C (-40 ... +266 °F)
- Other process fittings -40 ... +150 °C (-40 ... +302 °F)

Vessel pressure

- Screwed part PVDF -1 ... 2 bar (-100 ... 200 kPa/-14.5 ... 29.0 psig)
- Screwed part and flange 316L -1 ... 16 bar (-100 ... 1600 kPa/-14.5 ... 232 psig)

Vessel pressure relating to the flange nominal pressure stage see supplementary instructions manual "*Flanges according to DIN-EN-ASME-JIS*"

Vibration resistance 4 g at 5 ... 200 Hz according to EN 60068-2-6 (vibration with resonance)

Shock resistance 100 g, 6 ms according to EN 60068-2-27 (mechanical shock)

⁵⁾ Time span after a sudden measuring distance change by max. 0.5 m in liquid applications, max 2 m with bulk solids applications, until the output signal has taken for the first time 90 % of the final value (IEC 61298-2).

⁶⁾ Outside the specified beam angle, the energy level of the radar signal is 50% (-3 dB) less.

⁷⁾ EIRP: Equivalent Isotropic Radiated Power.

Electromechanical data - version IP 66/IP 67 and IP 66/IP 68; 0.2 bar

Options of the cable entry

- Cable entry M20 x 1.5; ½ NPT
- Cable gland M20 x 1.5; ½ NPT (cable ø see below table)
- Blind plug M20 x 1.5; ½ NPT
- Closing cap ½ NPT

Material cable gland	Material seal insert	Cable diameter				
		4.5 ... 8.5 mm	5 ... 9 mm	6 ... 12 mm	7 ... 12 mm	10 ... 14 mm
PA	NBR	-	●	●	-	●
Brass, nickel-plated	NBR	●	●	●	-	-
Stainless steel	NBR	-	●	●	-	●

Wire cross-section (spring-loaded terminals)

- Massive wire, stranded wire 0.2 ... 2.5 mm² (AWG 24 ... 14)
- Stranded wire with end sleeve 0.2 ... 1.5 mm² (AWG 24 ... 16)

Electromechanical data - version IP 66/IP 68 (1 bar)

Options of the cable entry

- Cable gland with integrated connection cable M20 x 1.5 (cable: ø 5 ... 9 mm)
- Cable entry ½ NPT
- Blind plug M20 x 1.5; ½ NPT

Connection cable

- Wire cross-section 0.5 mm² (AWG 20)
- Wire resistance < 0.036 Ω/m
- Tensile strength < 1200 N (270 lbf)
- Standard length 5 m (16.4 ft)
- Max. length 180 m (590.6 ft)
- Min. bending radius 25 mm (0.984 in) with 25 °C (77 °F)
- Diameter approx. 8 mm (0.315 in)
- Colour - Non-Ex version Black
- Colour - Ex-version Blue

Display and adjustment module

Display element Display with backlight

Measured value indication

- Number of digits 5

Adjustment elements

- 4 keys **[OK], [->], [+], [ESC]**
- Switch Bluetooth On/Off

Bluetooth interface

- Standard Bluetooth smart
- Effective range 25 m (82.02 ft)

Protection rating

- unassembled IP 20
- Mounted in the housing without lid IP 40

Materials

- Housing ABS
 - Inspection window Polyester foil
- Functional safety SIL non-reactive

Interface to the external display and adjustment unit

- Data transmission Digital (I²C-Bus)
- Connection cable Four-wire

Sensor version	Configuration, connection cable			
	Cable length	Standard cable	Special cable	Screened
4 ... 20 mA/HART	50 m	●	-	-
Profibus PA, Foundation Fieldbus	25 m	-	●	●

Integrated clock

- Date format Day.Month.Year
- Time format 12 h/24 h
- Time zone, factory setting CET
- Max. rate deviation 10.5 min/year

Additional output parameter - Electronics temperature

- Range -40 ... +85 °C (-40 ... +185 °F)
- Resolution < 0.1 K
- Deviation ±3 K

Output of the temperature values

- Indication Via the display and adjustment module
- Analogue Via the current output, the additional current output
- Digital Via the digital output signal (depending on the electronics version)

Voltage supply

- Operating voltage U_B
- Non-Ex instrument 9.6 ... 35 V DC
 - Ex-ia instrument 9.6 ... 30 V DC
 - Ex-d-ia instrument 15 ... 35 V DC

Operating voltage U_B (illuminated display and adjustment module)

- Non-Ex instrument 16 ... 35 V DC
- Ex-ia instrument 16 ... 30 V DC
- Ex-d-ia instrument No lighting possible (integrated ia barrier)

Reverse voltage protection Integrated

Permissible residual ripple - Non-Ex, Ex-ia instrument

- for $9.6\text{ V} < U_B < 14\text{ V}$ $\leq 0.7 V_{\text{eff}}$ (16 ... 400 Hz)
- for $18\text{ V} < U_B < 36\text{ V}$ $\leq 1.0 V_{\text{eff}}$ (16 ... 400 Hz)

Permissible residual ripple - Ex-d-ia instrument

- for $18\text{ V} < U_B < 36\text{ V}$ $\leq 1 V_{\text{eff}}$ (16 ... 400 Hz)

Load resistor

- Calculation $(U_B - U_{\text{min}})/0.022\text{ A}$
- Example - Non-Ex instrument with $U_B = 24\text{ V DC}$
 $(24\text{ V} - 9.6\text{ V})/0.022\text{ A} = 655\ \Omega$

Potential connections and electrical separating measures in the instrument

Electronics	Not non-floating
Reference voltage ⁹⁾	500 V AC
Conductive connection	Between ground terminal and metallic process fitting

Electrical protective measures

Housing material	Version	Protection acc. to IEC 60529	Protection acc. to NEMA
Plastic	Single chamber	IP 66/IP 67	Type 4X
	Double chamber	IP 66/IP 67	Type 4X
Aluminium	Single chamber	IP 66/IP 68 (0.2 bar) IP 68 (1 bar)	Type 6P -
	Double chamber	IP 66/IP 68 (0.2 bar) IP 68 (1 bar)	Type 6P -
Stainless steel (electro-polished)	Single chamber	IP 66/IP 68 (0.2 bar)	Type 6P
Stainless steel (precision casting)	Single chamber	IP 66/IP 68 (0.2 bar) IP 68 (1 bar)	Type 6P -
	Double chamber	IP 66/IP 68 (0.2 bar) IP 68 (1 bar)	Type 6P -

Connection of the feeding power supply unit Networks of overvoltage category III

Altitude above sea level

- by default up to 2000 m (6562 ft)
- with connected overvoltage protection up to 5000 m (16404 ft)

⁹⁾ Galvanic separation between electronics and metal housing parts

Pollution degree (with fulfilled housing protection)	4
Protection rating (IEC 61010-1)	III

Approvals

Instruments with approvals can have different technical specifications depending on the version.

For that reason the associated approval documents of these instruments have to be carefully noted. They are part of the delivery or can be downloaded under www.vega.com, "*Instrument search (serial number)*" as well as in the download area.

11.2 Dimensions

The following dimensional drawings represent only an extract of all possible versions. Detailed dimensional drawings can be downloaded at www.vega.com/downloads under "*Drawings*".

Plastic housing

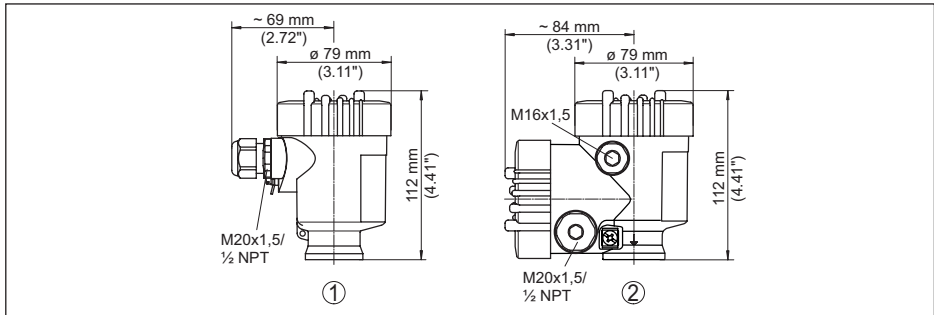

Fig. 47: Housing versions in protection IP 66/IP 67 (with integrated display and adjustment module the housing is 9 mm/0.35 in higher)

- 1 Plastic single chamber
- 2 Plastic double chamber

Aluminium housing

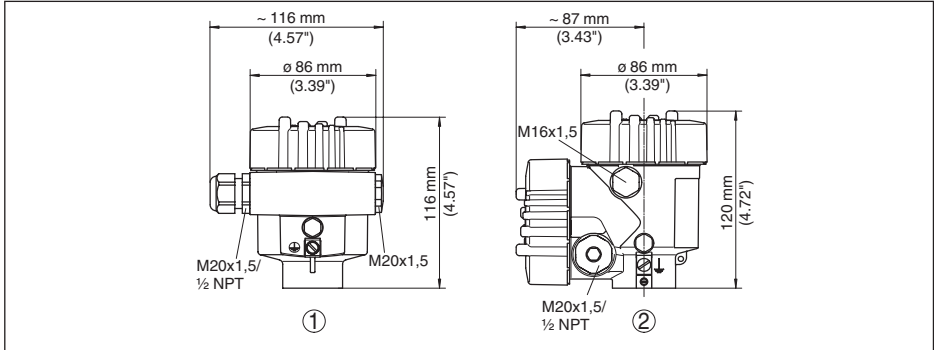

Fig. 48: Housing versions with protection rating IP 66/IP 68 (0.2 bar) (with integrated display and adjustment module the housing is 18 mm/0.71 in higher)

- 1 Aluminium - single chamber
- 2 Aluminium - double chamber

Aluminium housing with protection rating IP 66/IP 68 (1 bar)

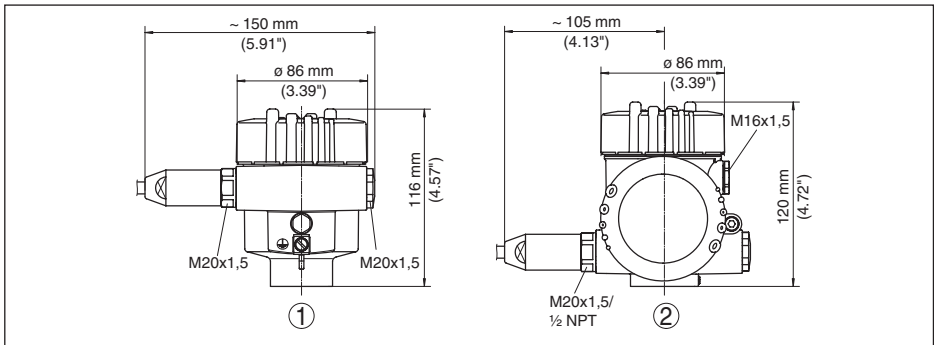

Fig. 49: Housing version with protection rating IP 66/IP 68 (1 bar), (with integrated display and adjustment module the housing is 18 mm/0.71 in higher)

- 1 Aluminium - single chamber
- 2 Aluminium - double chamber

VEGAPULS 65, threaded version

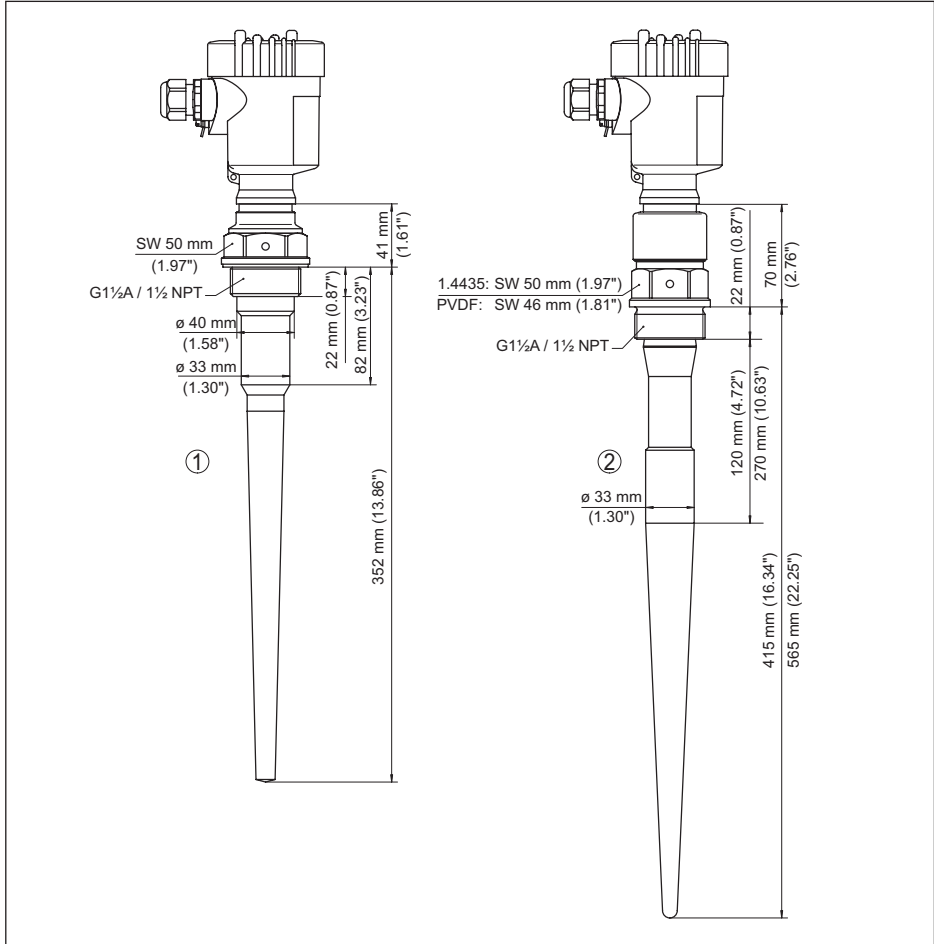

Fig. 50: VEGAPULS 65, threaded version

- 1 Thread and hexagon of PVDF for sockets with 50 mm height (inactive length 82 mm, 55/64")
- 2 Thread and hexagon of PVDF or 316L for sockets with 100 mm height (inactive length 120 mm, 4 23/32") or 250 mm height (inactive length 270 mm, 10 5/8")

VEGAPULS 65, flange version

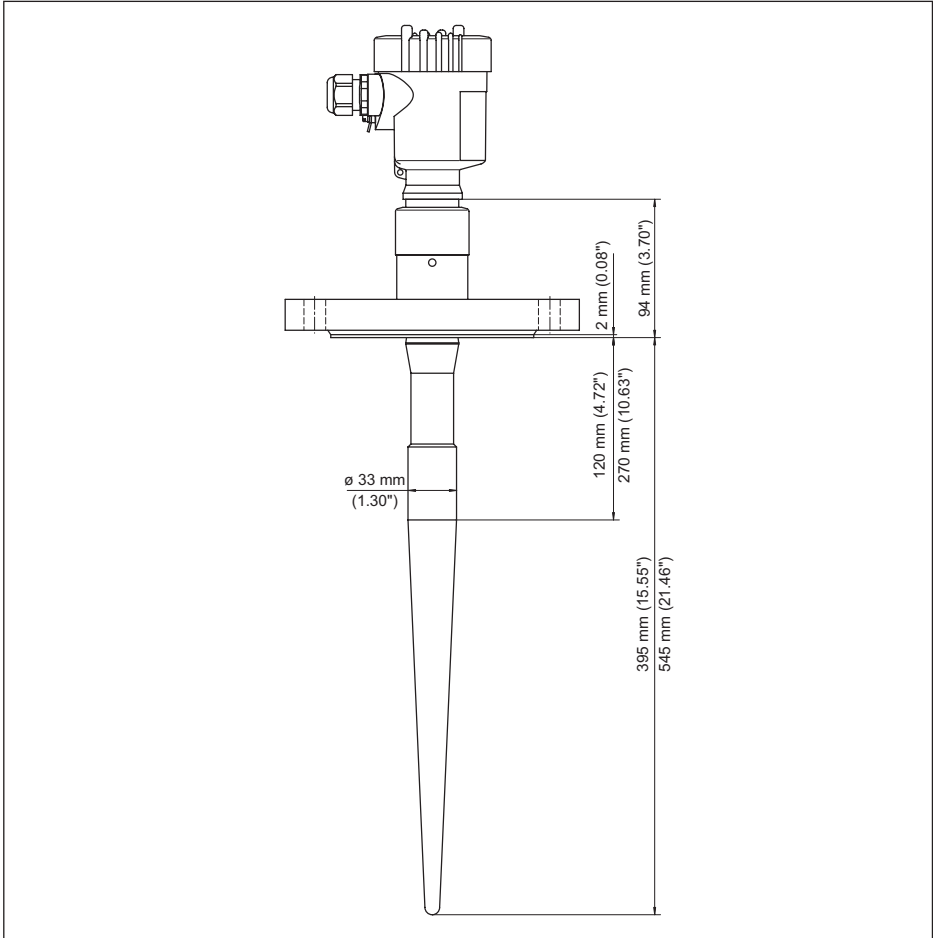

Fig. 51: VEGAPULS 65, flange version for sockets with 100 mm height (inactive length 120 mm, 4 23/32") or 250 mm height (inactive length 270 mm, 10 5/8")

11.3 Industrial property rights

VEGA product lines are global protected by industrial property rights. Further information see www.vega.com.

VEGA Produktfamilien sind weltweit geschützt durch gewerbliche Schutzrechte.

Nähere Informationen unter www.vega.com.

Les lignes de produits VEGA sont globalement protégées par des droits de propriété intellectuelle. Pour plus d'informations, on pourra se référer au site www.vega.com.

VEGA lineas de productos están protegidas por los derechos en el campo de la propiedad industrial. Para mayor información revise la pagina web www.vega.com.

Линии продукции фирмы ВЕГА защищаются по всему миру правами на интеллектуальную собственность. Дальнейшую информацию смотрите на сайте www.vega.com.

VEGA系列产品在全球享有知识产权保护。

进一步信息请参见网站www.vega.com。

11.4 Trademark

All the brands as well as trade and company names used are property of their lawful proprietor/originator.

INDEX**A**

Adjustment 36, 37
–System 28

B

Backlight 39

C

Check output signal 56
Connection cable 18
Copy instrument settings 45
Current output, min./max. 38
Current output mode 37

D

Damping 37
Date/Time 43
Default values 44
Deviation 57

E

Echo curve 41
EDD (Enhanced Device Description) 51
Electrical connection 19
Electronics and connection compartment 21
Electronics temperature 39
Error codes 55
Event memory 52

F

False signal suppression 41
Fault rectification 56

H

HART 48
HART mode 45

I

Instrument units 41
Instrument version 46

L

Language 38
Linearisation curve 42
Lock adjustment 38

M

Main menu 29
Measured value memory 52
Measurement loop name 30

Measurement reliability 40
Mounting socket 15

N

NAMUR NE 107 53, 54, 55

O

Overflow protection according to WHG 43

P

Peak value indicator 39
PIN 43

R

Reflection properties, medium 30
Repair 61
Reset 43

S

Sensor orientation 16
Sensor status 39
Service hotline 59
Simulation 40

V

Vessel form 35
Vessel height 35
Vessel installations 16

Printing date:

VEGA

All statements concerning scope of delivery, application, practical use and operating conditions of the sensors and processing systems correspond to the information available at the time of printing.

Subject to change without prior notice

© VEGA Grieshaber KG, Schiltach/Germany 2018



36515-EN-181127

VEGA Grieshaber KG
Am Hohenstein 113
77761 Schiltach
Germany

Phone +49 7836 50-0
Fax +49 7836 50-201
E-mail: info.de@vega.com
www.vega.com