

# DMP 334

## Industrial Pressure Transmitter for High Pressure

Thinfilm Sensor

accuracy according to IEC 60770:  
0.35 % FSO



### Nominal pressure

from 0 ... 600 bar up to 0 ... 2200 bar

### Analogue output

2-wire: 4 ... 20 mA  
3-wire: 0 ... 10 V  
others on request

### Special characteristics

- ▶ extremely robust and excellent long-term stability
- ▶ welded pressure sensor

### Optional versions

- ▶ IS-version  
Ex ia = intrinsically safe for gases and dusts
- ▶ pressure port:  
M20 x 1.5 or 9/16 UNF
- ▶ adjustability of span and offset
- ▶ different kinds of electrical connections

The industrial pressure transmitter DMP 334 has been especially designed for use in hydraulic systems up to 2200 bar. The base element of DMP 334 is a thinfilm sensor, which is welded with the pressure port and meets high demands of operational safety and reliability.

These characteristics and the excellent measurement data of DMP 334 as well as distinguished offset stability offer a pressure transmitter with easy handling, reliability, and robustness for hydraulic user. The DMP 334 is deliverable with standard HP connections.

### Preferred areas of use are





Plant and machine engineering



Commercial vehicles and mobile hydraulics

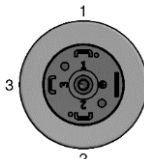
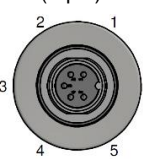
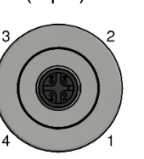
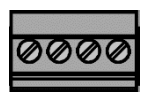

Input pressure range						
Nominal pressure gauge	[bar]	600 <sup>1</sup>	1000	1600	2000	2200
Overpressure	[bar]	800	1400	2200	2800	2800
Burst pressure ≥	[bar]	3000	4000	6000	6000	6000
<sup>1</sup> only available with pressure port G1/2" EN 837						
Output signal / Supply						
Standard	2-wire:	4 ... 20 mA / V <sub>S</sub> = 12 ... 36 V <sub>DC</sub>				
Option IS-protection	2-wire:	4 ... 20 mA / V <sub>S</sub> = 14 ... 28 V <sub>DC</sub>				
Option 3-wire	3-wire:	0 ... 10 V / V <sub>S</sub> = 14 ... 30 V <sub>DC</sub>				
Performance						
Accuracy <sup>2</sup>	≤ ± 0.35 % FSO					
Permissible load	current 2-wire:	$R_{max} = [(V_S - V_S \text{ min}) / 0.02 \text{ A}] \Omega$			voltage 3-wire: R <sub>min</sub> = 10 kΩ	
Influence effects	supply:	0.05 % FSO / 10 V			load: 0.05 % FSO / kΩ	
Long term stability	≤ ± 0.2 % FSO / year at reference conditions					
Response time	< 5 msec					
Adjustability <sup>3</sup>	adjustment of offset and span is possible within the range of ± 5 % of the nominal pressure range; please select "041" as a special version in the ordering code					
<sup>2</sup> accuracy according to IEC 60770 – limit point adjustment (non-linearity, hysteresis, repeatability)						
<sup>3</sup> adjustable version is not possible in combination with IS-version, compact field housing and cable outlet						
Thermal effects (offset and span)						
Thermal error	≤ ± 0.25 % FSO / 10 K					
in compensated range	-20 ... 85 °C					
Permissible temperatures						
Medium	-40 ... 140 °C					
Electronics / environment	-40 ... 85 °C					
Storage	-40 ... 100 °C					
Electrical protection						
Short-circuit protection	permanent					
Reverse polarity protection	no damage, but also no function					
Electromagnetic compatibility	emission and immunity according to EN 61326					
Mechanical stability						
Vibration	10 g RMS (20 ... 2000 Hz)			according to DIN EN 60068-2-6		
Shock	100 g / 11 msec.			according to DIN EN 60068-2-27		
Materials						
Pressure port	stainless steel 1.4542 (17-4 PH)					
Housing	stainless steel 1.4404 (316L)					
Option compact field housing	stainless steel 1.4301 (304); cable gland M12x1.5, brass, nickel plated (clamping range 2 ... 8 mm)					
Seals	none (welded version)					
Diaphragm	stainless steel 1.4542 (17-4 PH)					
Media wetted parts	pressure port, diaphragm					
Explosion protection (only for 4 ... 20 mA / 2-wire)						
Approvals	IBExU 10 ATEX 1068 X / IECEx IBE 12.0027X					
DX19-DMP 334	zone 0: II 1G Ex ia IIC T4 Ga			zone 20: II 1D Ex ia IIIC T135 °C Da		
Safety technical maximum values	U <sub>i</sub> = 28 V <sub>DC</sub> , I <sub>i</sub> = 93 mA, P <sub>i</sub> = 660 mW, C <sub>i</sub> ≈ 0 nF, L <sub>i</sub> ≈ 0 μH, the supply connections have an inner capacity of max. 27 nF to the housing					
Permissible temperatures for environment	in zone 0: -20 ... 60 °C with p <sub>atm</sub> 0.8 bar up to 1.1 bar in zone 1 or higher: -40/-20 ... 70 °C					
Connecting cables (by factory)	cable capacitance:		signal line/shield also signal line/signal line: 160 pF/m			
	cable inductance:		signal line/shield also signal line/signal line: 1 μH/m			
Miscellaneous						
Current consumption	signal output current: max. 25 mA		signal output voltage: max. 8.5 mA			
Weight	approx. 240 g					
Installation position	any					
Operational life	p <sub>N</sub> = 600 bar: 100 million load cycles			p <sub>N</sub> > 600 bar: 10 million load cycles		
CE-conformity	EMC Directive: 2014/30/EU			Pressure Equipment Directive: 2014/68/EU (module A)		
ATEX Directive	2014/34/EU					
Wiring diagrams						
<p>2-wire-system (current)</p>			<p>3-wire-system (current / voltage)</p>			

Pin configuration					
Electrical connection	ISO 4400	Binder 723 (5-pin)	M12x1 / metal (4-pin)	compact field housing	cable colours (IEC 60757)
				 V <sub>S+</sub> V <sub>S-</sub> S+ GND	
Supply + Supply - Signal + (only for 3-wire)	1 2 3	3 4 1	1 2 3	V <sub>S+</sub> V <sub>S-</sub> S+	WH (white) BN (brown) GN (green)
Shield	ground pin 	5	4	GND	GNYE (green-yellow)

### Electrical connections (dimensions mm / in)

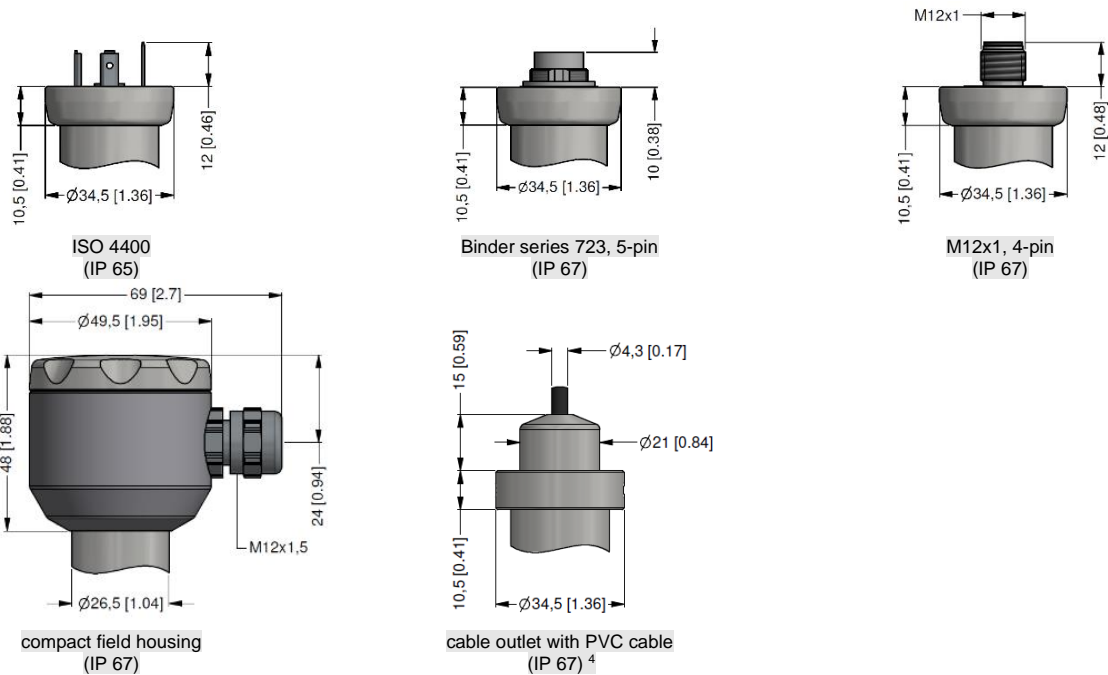

<sup>4</sup> standard: 2 m PVC cable without ventilation tube (permissible temperature: -5 ... 70 °C); others on request

### Mechanical connection (dimensions mm / in)

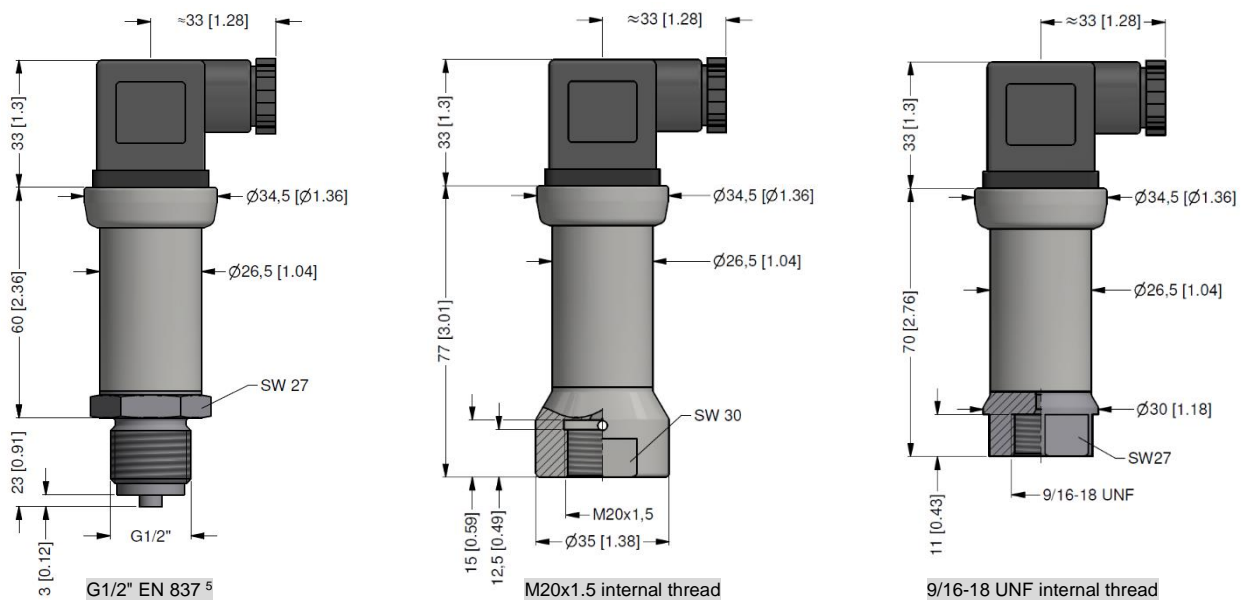

<sup>5</sup> According to EN 837, the pressure port and the complement at pressure over 1000 bar must be preferably made of stainless steel with a tensile strength of  $R_p > 260 \text{ N/mm}^2$  in accordance with DIN 17440. The maximum allowed pressure is 1600 bar!

© 2022 BD|SENSORS GmbH – The specifications given in this document represent the state of engineering at the time of publishing. We reserve the right to make modifications to the specifications and materials.

